

STP 21-1-SMCT

HEADQUARTERS  
DEPARTMENT OF THE ARMY

Soldier's Manual of Common Tasks

# Warrior Skills

## Level 1

OCTOBER 2006

**DISTRIBUTION RESTRICTION:**

Approved for public release; distribution is unlimited.

## **WARRIOR CREED**

**I am an American Soldier.**

**I am a Warrior and a member of a team.**

**I serve the people of the United States and live the Army  
Values.**

**I will always place the mission first.**

**I will never accept defeat.**

**I will never quit.**

**I will never leave a fallen comrade.**

**I am disciplined, physically and mentally tough, trained,  
and proficient in my warrior tasks and drills.**

**I always maintain my arms, my equipment, and myself.**

**I am an expert and I am a professional.**

**I stand ready to deploy, engage, and destroy  
the enemies of the United States of America  
in close combat.**

**I am a guardian of freedom and  
the American way of life.**

**I am an American Soldier.**

**This publication is available at  
Army Knowledge Online ([www.us.army.mil](http://www.us.army.mil)) and  
General Dennis J. Reimer Training and Doctrine  
Digital Library at ([www.train.army.mil](http://www.train.army.mil)).**

**SOLDIER'S MANUAL OF  
COMMON TASKS  
WARRIOR SKILLS LEVEL 1  
TABLE OF CONTENTS**

	Page
<b>PREFACE .....</b>	<b>x</b>
<b>Chapter 1 Introduction .....</b>	<b>1-1</b>
<b>Chapter 2 Training Guide.....</b>	<b>2-1</b>
<b>Chapter 3 Warrior Skills Level 1 Tasks.....</b>	<b>3-1</b>
<hr/>	
<b>Subject Area 1: Individual Conduct and Laws of War.....</b>	<b>3-1</b>
181-105-1001 Comply with the Law of War and the Geneva and Hague Conventions.....	3-1
224-176-1425 Interact with News Media.....	3-19
331-202-1049 Comply with the Requirements of the Code of Conduct.....	3-21
<hr/>	
<b>Subject Area 2: First Aid.....</b>	<b>3-23</b>
081-831-1001 Evaluate a Casualty (Tactical Combat Casualty Care).....	3-23
081-831-1003 Perform First Aid to Clear an Object Stuck in the Throat of a Conscious Casualty .....	3-28
081-831-1005 Perform First Aid to Prevent or Control Shock.....	3-30
081-831-1007 Perform First Aid for Burns.....	3-32
081-831-1008 Perform First Aid for Heat Injuries.....	3-35
081-831-1023 Perform First Aid to Restore Breathing and/or Pulse.....	3-37
081-831-1025 Perform First Aid for an Open Abdominal Wound.....	3-43
081-831-1026 Perform First Aid for an Open Chest Wound .....	3-45
081-831-1032 Perform First Aid for a Bleeding and/or Severed Extremity .....	3-49

**Distribution Restriction:** Approved for public release; distribution is unlimited.

\*This manual supersedes STP 21-1-SMCT, 11 October 2005.

081-831-1033	Perform First Aid for an Open Head Wound.....	3-54
081-831-1034	Perform First Aid for a Suspected Fracture .....	3-57
081-831-1044	Perform First Aid for Nerve Agent Injury .....	3-61
081-831-1045	Perform First Aid for Cold Injuries .....	3-69
081-831-1046	Transport a Casualty.....	3-74
081-831-1053	Practice Individual Preventive Medicine Countermeasures .....	3-78

---

**Subject Area 3: Chemical, Biological, Radiological, and Nuclear .....3-86**

031-503-1013	Decontaminate Yourself and Individual Equipment Using Chemical Decontaminating Kits .....	3-86
031-503-1015	Protect Yourself from Chemical, Biological, Radiological, and Nuclear (CBRN) Injury or Contamination with Mission-Oriented Protective Posture (MOPP) Gear.....	3-90
031-503-1018	React to Nuclear Hazard/Attack .....	3-93
031-503-1019	React to Chemical or Biological (CB) Hazard/Attack .....	3-96
031-503-1024	Replace Canister on Your M40-Series Protective Mask.....	3-98
031-503-1035	Protect Yourself from Chemical and Biological (CB) Contamination Using Your Assigned Protective Mask .....	3-101
031-503-1036	Maintain Your Assigned Protective Mask.....	3-105
031-503-1037	Detect Chemical Agents Using M8 or M9 Detector Paper.....	3-107
031-503-1040	Protect Yourself from CBRN Injury/Contamination with the JSLIST Chemical-Protective Ensemble.....	3-110
031-503-1042	Protect Yourself from CBRN Injury/Contamination When Changing MOPP (Using JSLIST) .....	3-113

---

**Subject Area 4: Survive (Combat Techniques) .....3-119**

052-192-1269	Detect Explosive-Hazard Indicators by Visual Means .....	3-119
071-000-0006	React to Man-to-Man Contact .....	3-124
071-326-0502	Move Under Direct Fire .....	3-128
071-326-0503	Move Over, Through, or Around Obstacles (Except Minefields) .....	3-133
071-326-0510	React to Indirect Fire While Dismounted.....	3-135

071-326-0511	React to Flares .....	3-136
071-326-0513	Select Temporary Fighting Positions .....	3-137
071-326-0541	Perform Movement Techniques During an Urban Operation .....	3-139
071-326-0542	Enter a Building During an Urban Operation .....	3-144
071-326-3002	React to Indirect Fire While Mounted .....	3-150
071-410-0002	React to Direct Fire While Mounted.....	3-151
093-401-5040	React to Unexploded Ordnance Hazards .....	3-152
171-137-0001	Search Vehicles in a Tactical Environment .....	3-162
191-376-5140	Search a Vehicle for Explosive Devices or Prohibited Items at an Installation Access Control Point .....	3-164
191-376-5141	Search a Commercial Vehicle for Explosive Devices or Prohibited Items at an Installation Access Control Point.....	3-170
191-376-5151	Control Access to a Military Installation .....	3-181
551-721-1359	Operate a Vehicle in a Convoy .....	3-185
<hr/>		
<b>Subject Area 5:</b>	<b>Navigate .....</b>	<b>3-188</b>
061-283-1001	Determine Direction Within the Target Area.....	3-188
071-329-1000	Identify Topographic Symbols on a Military Map.....	3-190
071-329-1001	Identify Terrain Features on a Map.....	3-193
071-329-1002	Determine the Grid Coordinates of a Point on a Military Map.....	3-198
071-329-1003	Determine a Magnetic Azimuth Using a Lensatic Compass.....	3-204
071-329-1004	Determine the Elevation of a Point on the Ground Using a Map.....	3-207
071-329-1005	Determine a Location on the Ground by Terrain Association .....	3-211
071-329-1006	Navigate from One Point on the Ground to Another Point While Dismounted.....	3-212
071-329-1008	Measure Distance on a Map.....	3-220
071-329-1009	Convert Azimuths.....	3-223
071-329-1011	Orient a Map Using a Lensatic Compass .....	3-226

071-329-1012	Orient a Map to the Ground by Map-Terrain Association.....	3-227
071-329-1014	Locate an Unknown Point on a Map and on the Ground by Intersection .....	3-228
071-329-1015	Locate an Unknown Point on a Map and on the Ground by Resection .....	3-231
071-329-1018	Determine Direction Without a Compass .....	3-235
071-329-1030	Navigate from One Point on the Ground to Another Point While Mounted .....	3-238
071-510-0001	Determine Azimuths Using a Protractor .....	3-243
071-510-0002	Compute Back Azimuths.....	3-245
<b>Subject Area 6:</b>	<b>Communicate .....</b>	<b>3-246</b>
113-571-1022	Perform Voice Communications .....	3-246
113-587-1064	Prepare SINCGARS (Manpack) for Operation .....	3-252
113-587-2070	Operate SINCGARS Single-Channel (SC).....	3-253
113-600-2001	Communicate Via a Tactical Telephone.....	3-254
<b>Subject Area 7:</b>	<b>See .....</b>	<b>3-255</b>
071-331-0804	Perform Surveillance Without the Aid of Electronic Devices.....	3-255
071-730-0014	Identify Combat Vehicles.....	3-258
<b>Subject Area 8:</b>	<b>Hand Grenades and Land Mines .....</b>	<b>3-260</b>
071-325-4401	Perform Safety Checks on Hand Grenades.....	3-260
071-325-4407	Employ Hand Grenades.....	3-263
071-325-4425	Employ an M18A1 Claymore Mine .....	3-265
071-325-4426	Recover an M18A1 Claymore Mine.....	3-273
<b>Subject Area 9:</b>	<b>M16-Series Rifle.....</b>	<b>3-274</b>
071-311-2006	Construct Field-Expedient Firing Aids for an M16A1/A2 Rifle.....	3-274
071-311-2007	Engage Targets with an M16-Series Rifle.....	3-276
071-311-2025	Maintain an M16-Series Rifle .....	3-281
071-311-2026	Perform a Function Check on an M16-Series Rifle.....	3-301
071-311-2027	Load an M16-Series Rifle.....	3-304

071-311-2028	Unload an M16-Series Rifle .....	3-309
071-311-2029	Correct Malfunctions of an M16-Series Rifle.....	3-310
<hr/>		
<b>Subject Area 10:</b>	<b>M240B Machine Gun.....</b>	<b>3-312</b>
071-025-0001	Maintain an M240B Machine Gun .....	3-312
071-025-0002	Perform a Function Check on an M240B Machine Gun .....	3-319
071-025-0003	Load an M240B Machine Gun.....	3-321
071-025-0004	Unload an M240B Machine Gun.....	3-322
071-025-0005	Correct Malfunctions of an M240B Machine Gun.....	3-323
071-025-0007	Engage Targets with an M240B Machine Gun.....	3-326
071-025-0015	Mount an M240B Machine Gun on an M122A1 Tripod .....	3-329
071-025-0016	Dismount an M240B Machine Gun from an M122A1 Tripod .....	3-330
<hr/>		
<b>Subject Area 11:</b>	<b>M249 Machine Gun .....</b>	<b>3-331</b>
071-010-0006	Engage Targets with an M249 Machine Gun.....	3-331
071-312-4025	Maintain an M249 Machine Gun .....	3-339
071-312-4026	Perform a Function Check on an M249 Machine Gun.....	3-359
071-312-4027	Load an M249 Machine Gun .....	3-360
071-312-4028	Unload an M249 Machine Gun.....	3-363
071-312-4029	Correct Malfunctions of an M249 Machine Gun .....	3-364
<hr/>		
<b>Subject Area 12:</b>	<b>MK19 Machine Gun .....</b>	<b>3-368</b>
071-030-0001	Maintain an MK19 Machine Gun .....	3-368
071-030-0004	Engage Targets with an MK19 Machine Gun.....	3-385
071-030-0005	Load an MK19 Machine Gun .....	3-392
071-030-0006	Unload an MK19 Machine Gun.....	3-396
071-030-0007	Perform a Function Check on an MK19 Machine Gun.....	3-398
071-030-0008	Correct Malfunctions of an MK19 Machine Gun .....	3-400
<hr/>		
<b>Subject Area 13:</b>	<b>Caliber .50 M2 Machine Gun.....</b>	<b>3-405</b>
071-022-0001	Maintain a Caliber .50 M2 Machine Gun .....	3-405
071-022-0003	Load a Caliber .50 M2 Machine Gun.....	3-432

071-022-0004	Unload a Caliber .50 M2 Machine Gun.....	3-433
071-022-0005	Correct Malfunctions of a Caliber .50 M2 Machine Gun.....	3-435
071-313-3454	Engage Targets with a Caliber .50 M2 Machine Gun.....	3-439
<hr/>		
<b>Subject Area 14:</b>	<b>M136 Launcher.....</b>	<b>3-446</b>
071-054-0001	Prepare an M136 Launcher for Firing .....	3-446
071-054-0002	Restore an M136 Launcher to Carrying Configuration .....	3-451
071-054-0003	Perform Misfire Procedures on an M136 Launcher.....	3-452
071-054-0004	Engage Targets with an M136 Launcher.....	3-454
<hr/>		
<b>Subject Area 15:</b>	<b>M203 Grenade Launcher .....</b>	<b>3-462</b>
071-311-2125	Maintain an M203 Grenade Launcher .....	3-462
071-311-2126	Perform a Function Check on an M203 Grenade Launcher.....	3-467
071-311-2127	Load an M203 Grenade Launcher .....	3-468
071-311-2128	Unload an M203 Grenade Launcher.....	3-469
071-311-2129	Correct Malfunctions of an M203 Grenade Launcher .....	3-470
071-311-2130	Engage Targets with an M203 Grenade Launcher.....	3-471
<hr/>		
<b>Subject Area 16:</b>	<b>M4 Carbine .....</b>	<b>3-477</b>
071-100-0001	Zero an M4 or M4A1 Carbine.....	3-477
071-100-0003	Engage Targets with an M4 or M4A1 Carbine.....	3-480
071-100-0004	Maintain an M4 or M4A1 Carbine .....	3-482
071-100-0005	Perform a Function Check on an M4 or M4A1 Carbine .....	3-489
071-100-0006	Load an M4 or M4A1 Carbine .....	3-490
071-100-0007	Unload an M4 or M4A1 Carbine.....	3-492
071-100-0008	Correct Malfunctions of an M4 or M4A1 Carbine .....	3-493
<hr/>		
<b>Subject Area 17</b>	<b>Sights, Night, Day, Aiming Devices .....</b>	<b>3-494</b>
071-008-0007	Engage Targets with an M16-Series Rifle Using an AN/PAS-13-Series Thermal Weapon Sight.....	3-494
071-008-0011	Engage Targets with an M16-Series Rifle Using an AN/PAQ-4-Series Aiming Light .....	3-496



071-010-0002	Mount a Night Vision Sight, AN/PVS-4, on an M249 Machine Gun .....	<b>3-498</b>
071-010-0003	Dismount a Night Vision Sight, AN/PVS-4, from an M249 Machine Gun .....	<b>3-500</b>
071-010-0007	Engage Targets with an M249 Machine Gun Using a Night Vision Sight, AN/PVS-4.....	<b>3-501</b>
071-010-0008	Mount an AN/PAS-13 Thermal Weapon Sight on an M249 Machine Gun .....	<b>3-503</b>
071-010-0009	Dismount an AN/PAS-13 Thermal Weapon Sight from an M249 Machine Gun.....	<b>3-505</b>
071-010-0011	Engage Targets with an M249 Machine Gun Using an AN/PAS-13 Thermal Weapon Sight.....	<b>3-506</b>
071-022-0008	Mount a Night Vision Sight, AN/TVS-5, on a Caliber .50 M2 Machine Gun.....	<b>3-508</b>
071-022-0009	Dismount a Night Vision Sight, AN/TVS-5, from a Caliber .50 M2 Machine Gun .....	<b>3-509</b>
071-022-0017	Mount an AN/PAS-13 Thermal Weapon Sight on a Caliber .50 M2 Machine Gun .....	<b>3-510</b>
071-022-0018	Dismount an AN/PAS-13 Thermal Weapon Sight from a Caliber .50 Machine Gun .....	<b>3-512</b>
071-022-0020	Engage Targets with a Caliber .50 M2 Machine Gun Using an AN/PAS-13 Thermal Weapon Sight.....	<b>3-513</b>
071-025-0027	Mount an AN/PEQ-2A-Series Aiming Light on an M240B Machine Gun .....	<b>3-514</b>
071-025-0028	Dismount an AN/PEQ-2A-Series Aiming Light from an M240B Machine Gun.....	<b>3-515</b>
071-025-0030	Engage Targets with an M240B Machine Gun Using an AN/PEQ-2A-Series Aiming Light .....	<b>3-516</b>
071-030-0016	Mount a Night Vision Sight, AN/TVS-5, on an MK19 Machine Gun .....	<b>3-517</b>
071-030-0017	Dismount a Night Vision Sight, AN/TVS-5, from an MK19 Machine Gun .....	<b>3-518</b>
071-030-0019	Engage Targets with an MK19 Machine Gun Using a Night Vision Sight, AN/TVS-5.....	<b>3-519</b>
071-100-0017	Mount an AN/PAQ-4-Series Aiming Light on an M4 or M4A1 Carbine.....	<b>3-520</b>
071-100-0020	Zero an AN/PAQ-4-Series Aiming Light to an M4 or M4A1 Carbine .....	<b>3-522</b>

071-705-0001	Maintain an M68 Sight.....	3-523
071-705-0002	Operate an M68 Sight.....	3-525
071-705-0003	Zero an M68 Sight.....	3-526
071-705-0004	Boresight an M68 Sight.....	3-528

---

**Subject Area 18: M9 Pistol 9-mm.....3-533**

071-004-0001	Maintain an M9 Pistol .....	3-533
071-004-0003	Load an M9 Pistol .....	3-539
071-004-0004	Unload an M9 Pistol.....	3-540
071-004-0005	Correct Malfunctions of an M9 Pistol .....	3-542
071-004-0006	Engage Targets with an M9 Pistol.....	3-543

---

**Subject Area 19: Casualty Reporting and Handling.....3-550**

101-515-1997	Inter Isolated Remains (After Receiving Authorization) .....	3-550
101-515-1998	Evacuate Isolated Remains.....	3-552
101-515-1999	Recover Isolated Remains .....	3-554

---

**Subject Area 20: Defense Measures .....**3-557

052-191-1361	Camouflage Yourself and Your Individual Equipment .....	3-557
071-000-0005	Prepare a Range Card for a Machine Gun .....	3-561
071-326-0550	Prepare Positions for Individual and Crew-Served Weapons During an Urban Operation .....	3-567
071-326-0557	Select Hasty Firing Positions During an Urban Operation.....	3-574
071-326-0608	Use Visual Signaling Techniques.....	3-577
071-326-5703	Construct Individual Fighting Positions .....	3-592
071-331-0801	Challenge Persons Entering Your Area.....	3-599
071-331-0815	Practice Noise, Light, and Litter Discipline.....	3-601
071-331-0852	Clear a Field of Fire.....	3-602
071-331-1004	Perform Duty as a Guard.....	3-604
071-440-0028	Engage Targets During an Urban Operation.....	3-605
191-376-4114	Control Entry to and Exit from a Restricted Area .....	3-608
191-377-4254	Search a Detainee .....	3-611

191-377-4256	Guard Detainees.....	3-618
301-348-1050	Report Information of Potential Intelligence Value.....	3-621
301-371-1000	Report Intelligence Information.....	3-623
301-371-1050	Implement Operations Security (OPSEC) Measures .....	3-625
<b>Chapter 4</b>	<b>Warrior Tasks and Battle Drills Trainer’s Guide.....</b>	<b>4-1</b>
<b>Appendix A</b>	<b>Proponent School or Agency Codes.....</b>	<b>A-1</b>
<b>Appendix B</b>	<b>Guide to Forms .....</b>	<b>B-1</b>
<b>Glossary</b>	.....	<b>Glossary-1</b>
<b>References</b>	.....	<b>References-1</b>

## PREFACE

This manual is one of a series of Soldier training publications that support individual training. Commanders, trainers, and Soldiers will use this manual and STP 21-24-SMCT to plan, conduct, sustain, and evaluate individual training of warrior tasks and battle drills in units.

This manual contains an Army Warrior Training plan for warrior skills level (SL) 1 through 4 and task summaries for SL 1 critical common tasks that support unit wartime missions. This manual is the only authorized source for these common tasks. Task summaries in this manual supersede any common tasks appearing in MOS-specific Soldier manuals.

Training support information, such as reference materials, is also included. Trainers and first-line supervisors should ensure SL 1 Soldiers have access to this publication in their work areas, unit learning centers, and unit libraries.

This manual applies to the Active Army, the Army National Guard (ARNG)/Army National Guard of the United States (ARNGUS), and the U.S. Army Reserve (USAR).

The proponent of this publication is the Commander, United States Army Training and Doctrine Command (TRADOC), with the Commander, United States Army Training Support Center (ATSC) designated as the principle publishing, printing, and distribution agency. Proponents for the specific tasks are the Army schools and agencies as identified by the school code, listed in appendix A. This code consists of the first three digits of the task identification number.

Record any comments or questions regarding the task summaries contained in this manual on a DA Form 2028 (*Recommended Changes to Publications and Blank Forms*) and send it to the respective task proponent with information copies forwarded to—

- Commander, U.S. Army Training and Doctrine Command, ATTN: ATTG-I, Fort Monroe, VA 23651-5000.
- Commander, U.S. Army Training Support Center, ATTN: ATIC-ITSC-CM, Fort Eustis, VA 23604-5166.

## Chapter 1

# Introduction to the SMCT System

### 1-1. GENERAL

The Army's basic mission is to train and prepare Soldiers, leaders, and units to fight and win in combat. As explained in the Army's capstone training doctrine (FM 7-0), units do not have the time or the resources to achieve and sustain proficiency on every possible training task. Therefore, commanders must identify the tasks that are the units' critical wartime tasks. These tasks then become the unit's mission essential task list (METL). Commanders use the METL to develop their unit-training plan. Noncommissioned officers (NCOs) plan the individual training that Soldiers need to become warriors and to accomplish the METL. The Soldier training publications (STPs), also known as Soldier's manuals (SMs), provide the critical individual tasks for each military occupational specialty (MOS) that support the unit's full spectrum of missions. The NCO leadership uses the tasks in the SMs to train the Soldiers and measure the Soldier's proficiency on these unit-critical tasks. The manuals provide task performance and evaluation criteria and are the basis for individual training and evaluation in the unit and for task-based evaluation during resident training.

*Note:* The Army identified warrior tasks and battle drills that enhance a Soldier's readiness to fight on the battlefield. Standards remain constant but commanders must be aware that the enemy adapts quickly and Soldier training will change more rapidly because of current operational environments.

### 1-2. PURPOSE

This Soldier's Manual of Common Tasks (SMCT), Warrior Skill Level (SL) 1, contains the individual tasks that are essential to the Army's ability to win on the modern battlefield. In an operational environment, regardless of job or individual MOS, each Soldier risks exposure to hostile actions. This manual contains the warrior skills that Soldiers must be able to perform to fight, survive, and win in combat.

This SMCT gives the commander, NCO trainer or first-line supervisor, and individual Soldiers the information necessary to support integration and sustainment training in their units. This information allows trainers to plan, prepare, train, evaluate, and monitor individual training of warrior tasks. Using the appropriate mission training plan (MTP), MOS-specific STPs, and this manual helps provide the foundation for an effective unit-training plan.

### 1-3. COMMANDER'S RESPONSIBILITIES

The commander at each level develops a unit METL in consultation with the command sergeant major and subordinate commanders. Using the training planning process described in FM 7-0, the commander develops the METL and then determines the level of training needed to attain and maintain proficiency. Warrior tasks and battle drills in chapter 4 support an Army at war and become the key element in Army Warrior Training (AWT). Commanders use the unit METL and AWT to determine the necessary training for the unit, and develop a strategy to accomplish the required training throughout the FY. The commander also gives the NCO leadership the guidance they need to carry out this strategy. Each commander must design a unit training plan that prepares the unit for the full spectrum of

operations. Soldiers must develop and sustain proficiency in the critical tasks for their MOS and skill level. The commander's unit training program should provide individual training for all Soldiers assigned to the unit and routinely evaluate Soldier proficiency. The leader's assessment and the AWT are two tools that give the NCO leadership and commander feedback on the status of training for individuals and for the unit. This feedback should also be integrated with collective training such as the MTP and crew drills. The Warrior Training Plan, located in chapter 2, provides information on where the warrior tasks are first trained to standard and how often the tasks should be trained to maintain proficiency.

Based on the commander's guidance, individual training in the unit is the responsibility of the NCO trainers. The commander must give the NCO trainer the priorities, resources, and direction needed to carry out training. He or she must also assess the training results of the MTP and other training events, and adjust the unit-training plan accordingly. To develop a training program, use the following seven-step approach:

- Step 1.** Set the objectives for training.
- Step 2.** Plan the resources (personnel, time, funds, facilities, devices, and training aids).
- Step 3.** Train the trainers.
- Step 4.** Provide the resources.
- Step 5.** Manage risks and environmental and safety concerns.
- Step 6.** Conduct the training.
- Step 7.** Evaluate the results.

#### **1-4. TRAINER'S RESPONSIBILITIES**

Trainers use the following steps to plan and evaluate training.

- a. *Identify individual training requirements.*** The NCO determines which tasks Soldiers need to train based on the commander's training strategy. The unit's training plan, METL, MTP, and the AWT plan (chapter 2) are sources for helping the trainer define the individual training needed.
- b. *Plan the training.*** Plan individual training based on the unit's training plan. Be prepared to take advantage of opportunities to conduct individual training ("hip pocket" training).
- c. *Gather the training references and materials.*** The task summaries list references that can assist the trainer in preparing for the training of that task. Check the Reimer Digital Library to see if any new resources have been added.
- d. *Manage risks and environmental and safety concerns.*** Assess the risks involved in training a specific task under the conditions current at the time you are scheduled to train and if necessary, implement controls to lessen the risk level. Ensure that training preparation takes into account those cautions, warnings, and dangers associated with each task as well as environmental and safety concerns.
- e. *Train each Soldier.*** Show the Soldier how to do the task to standard and explain (step by step) how to do the task. Give each Soldier a chance to practice the task step by step.

**f. Check each Soldier.** Evaluate how well each Soldier performs the tasks in this manual. Conduct these evaluations during individual training sessions or while evaluating individual proficiency when conducting unit collective tasks. This manual provides a training and evaluation guide for each task to enhance the NCO's ability to conduct year-round, hands-on evaluations of tasks critical to the unit's mission. Use the information in the AWT plan (chapter 2) as a guide to determine how often to train the Soldier on each task to maintain proficiency.

**g. Record the results.** Use the leader book referred to in FM 7-1 to record task performance. This gives the leader total flexibility on the method of recording training. The trainer may use DA Form 5164-R (*Hands-on Evaluation*) and DA Form 5165-R (*Field Expedient Squad Book*) as part of the leader book. These forms are optional and locally reproducible. More information on using these forms is in appendix B of this manual.

**h. Retrain and evaluate.** Work with each Soldier until the individual performs the task to standard. Well-planned, integrated training increases the professional competence of each Soldier and contributes to the development of an efficient unit. The NCO or first-line supervisor is a vital link in the conduct of training.

## 1-5. SOLDIER'S RESPONSIBILITIES

Each Soldier must be able to perform the individual tasks that the first-line supervisor has identified based on the unit's METL. The Soldier must perform the task to the standard listed in this SMCT. If a Soldier has a question about how to do a task, or which tasks in this manual he or she must perform, it is the Soldier's responsibility to go to the first-line supervisor for clarification. The first-line supervisor knows how to perform each task or can direct the Soldier to the appropriate training materials. Additionally, each Soldier should—

**a.** Know the training progression for both the warrior tasks and battle drills (WTBD) and the MOS-specific critical tasks for his or her skill level. Lists of the critical tasks can be found in chapter 2 of this manual and the STP for the specific MOS (MOS-specific tasks).

**b.** Check the Reimer Digital Library for new training materials to support self-development either to maintain previously trained tasks or to learn new tasks.

## 1-6. TASK SUMMARIES

Task summaries document the performance requirements of a critical warrior task. They provide the Soldier and the trainer with the information necessary to evaluate critical tasks. The format for the task summaries is—

**a. Task title.** The task title identifies the action to perform.

**b. Task number.** The task number is a 10-digit number that identifies each task. The first three digits of the number represent the proponent code for that task. (A list of the proponent codes is given in appendix A.) Include the entire 10-digit task number, along with the task title, in any correspondence relating to the task.

**c. Conditions.** The task conditions identify all the equipment, tools, materials, references, job aids, and supporting personnel that the Soldier needs to perform the task. This section identifies any environmental conditions that can alter task performance such as visibility, temperature, or wind. This section also identifies

any specific cues or events (for example, a chemical attack, or identification of an unexploded ordnance hazard) that trigger task performance.

**d. Standards.** A task standard specifies the requirements for task performance by indicating how well, completely, or accurately a product must be produced, a process must be performed, or both. Standards are described in terms of accuracy, tolerances, completeness, format, clarity, number of errors, quantity, sequence, or speed of performance.

**e. Training and evaluation guide.** This section has two parts. The first part, Performance Steps, lists the individual steps that the Soldier must complete to perform the task. The second part is the Performance Evaluation Guide. This provides guidance on how to evaluate a Soldier's performance of the task. It is composed of three subsections. The *Evaluation Preparation* subsection identifies special setup procedures and, if required, instructions for evaluating the task performance. Sometimes the conditions and standards must be modified so that the task can be evaluated in a situation that does not exactly duplicate actual field performance. The *Performance Measures* subsection identifies the criteria for acceptable task performance. The Soldier is rated (GO/NO GO) on how well he or she performs specific actions or produces specific products. As indicated in the *Evaluation Guidance*, the Soldier must score a GO on all or specified performance measures to receive a GO on the task and be considered trained.

**f. References.** This section identifies references that provide more detailed and thorough explanations of task performance requirements than that given in the task summary description. This section identifies resources the Soldier can use to improve or maintain performance.

**g.** Additionally, task summaries can include safety statements, environmental considerations, and notes. Safety statements (danger, warning, and caution) alert users to the possibility of immediate death, personal injury, or damage to equipment. Notes provide additional information to support task performance.

## 1-7. TRAINING TIPS FOR NCO LEADERS

**a.** Prepare yourself:

(1) Get training guidance from your chain of command on when to train, which Soldiers to train, availability of resources, and a training site.

(2) Get task conditions and standards from the task summary in this manual.

(3) Ensure that you can do the task. Review the task summary and the references in the reference section. Practice doing the task or, if necessary, have someone train you on the task.

**b.** Prepare the resources:

(1) Obtain the required resources as identified in the conditions statement for each task and/or modified in the training and evaluation guide.

(2) Gather the equipment and ensure that it is operational.

(3) Prepare a training outline consisting of informal notes on what you want to cover during your training session.

(4) Practice your training presentation.



- (5) Coordinate for the use of training aids and devices.
  - (6) Prepare the training site using the conditions statement as modified in the training and evaluation guide.
- c. Train the Soldiers:
- (1) Tell the Soldier what task to do and how well it must be done. Refer to the task standards and the performance measures for the task, as appropriate.
  - (2) Caution Soldiers about safety, environment, and security considerations.
  - (3) Demonstrate how to do the task to the standard. Have the Soldiers study the appropriate training materials.
  - (4) Provide any necessary training on basic skills that Soldiers must have before they can be proficient with the task.
  - (5) Have the Soldiers practice the task until they can perform it to standard.
  - (6) Provide feedback to those Soldiers who fail to perform to the SMCT standards, and have them continue to practice until they can perform to the SMCT standards.
  - (7) Combine training on the individual tasks contained in this manual with the collective tasks contained in the MTP. Ensure that the necessary safety equipment and clothing needed for proper performance of the job are on hand at the training site.
- d. Record the results: First-line supervisors record the results and report information to unit leadership.

## **1-8. TRAINING SUPPORT**

This manual includes the following that provide additional training support information.

- a. Appendix A lists the task proponents and agency codes (first three digits of the task number) with addresses for submitting comments concerning specific tasks in this manual.
- b. Appendix B explains the use of various SMCT training and evaluation forms and, in the online version of this manual, provides links to the forms.

## **1-9. EVALUATING TASK PERFORMANCE**

Trainers need to keep the following points in mind when preparing to evaluate their Soldiers—

- a. Review the performance measures to become familiar with the criteria on which the Soldier will be scored.
- b. Ensure that all necessary equipment and clothing needed for proper performance of the job are on hand at the training site. Remember to include safety equipment.
- c. Prepare the test site according to the conditions section of the task summary. Some tasks contain special evaluation preparation instructions. These

instructions tell the trainer what modifications must be made to the job conditions to evaluate the task. Reset the site to its original condition after evaluating each Soldier to ensure that the conditions are the same for each Soldier.

**d.** Advise each Soldier of any special guidance that appears in the evaluation preparation section of the task summary before evaluating.

**e.** Score each Soldier based on the information in the performance measures and evaluation guidance. Record the date and task performance score (GO or NO GO) in the sections training records.

**(1)** When applicable, conduct an exercise after-action review to allow training participants to discover for themselves what happened, why it happened, and how it can be done better. Once all key points have been discussed and linked to future training, the evaluator will make the appropriate notes for inclusion into the score.

**(2)** Score the Soldier GO if all performance measures are passed. Score the Soldier NO GO if any step is failed. If the Soldier fails any step, show or tell him or her what was done wrong and how to do it correctly.

## Chapter 2

# Training Guide

### 2-1. THE ARMY WARRIOR TRAINING PLAN

The AWT plan provides information to help the trainer plan, prepare, train, evaluate, and monitor individual training in units. It lists by general subject area and skill level the critical warrior tasks that Soldiers must perform, the initial training location, and a suggested frequency of training. The training location column uses brevity codes to indicate where the task is first taught to standards. If the task is taught in the unit the word, "UNIT" appears in this column. Tasks trained via self-development media are indicated by "SD." If it is taught in the training base, the brevity code (BCT, OSUT, and AIT) of the resident course appears. Brevity codes and resident courses are listed below.

<b>Brevity Codes</b>	
ANCOG	Advanced NCO Course
BNCOG	Basic NCO Course
WLC	Warrior Leaders Course
BCT	Basic Combat Training
OSUT	One Station Unit Training
AIT	Advanced Individual Training
UNIT	Trained in / by the Unit
SD	Self-Development Training

The sustainment training column lists how often (frequency) Soldiers should train on the task to ensure they maintain their proficiency. This information is a guide for commanders to develop a comprehensive unit-training plan. The commander, in conjunction with the unit trainers, is in the best position to determine on which tasks and how often Soldiers need training to maintain unit readiness.

<b>Frequency Codes</b>	
AN	Annually
SA	Semiannually
QT	Quarterly

<b>Army Warrior Training Plan</b>			
<b>Task Number</b>	<b>Title</b>	<b>Training Location</b>	<b>Sustainment Training Frequency</b>
<b>Warrior Skill Level 1</b>			
<b>Subject Area 1. Individual Conduct and Laws of War</b>			
<b>181-105-1001</b>	Comply with the Law of War and the Geneva and Hague Conventions	BCT/ OSUT	AN
<b>224-176-1425</b>	Interact with News Media	BCT/ OSUT	AN
<b>331-202-1049</b>	Comply with the Requirements of the Code of Conduct	BCT/ OSUT	AN
<b>Subject Area 2. First Aid</b>			
<b>081-831-1001</b>	Evaluate a Casualty (Tactical Combat Casualty Care)	BCT/ OSUT	AN
<b>081-831-1003</b>	Perform First Aid to Clear an Object Stuck in the Throat of a Conscious Casualty	BCT/ OSUT	AN
<b>081-831-1005</b>	Perform First Aid to Prevent or Control Shock	BCT/ OSUT	AN
<b>081-831-1007</b>	Perform First Aid for Burns	BCT/ OSUT	AN
<b>081-831-1008</b>	Perform First Aid for Heat Injuries	BCT/ OSUT	AN
<b>081-831-1023</b>	Perform First Aid to Restore Breathing and/or Pulse	BCT/ OSUT	AN
<b>081-831-1025</b>	Perform First Aid for an Open Abdominal Wound	BCT/ OSUT	AN
<b>081-831-1026</b>	Perform First Aid for an Open Chest Wound	BCT/ OSUT	AN
<b>081-831-1032</b>	Perform First Aid for a Bleeding and/or Severed Extremity	BCT/ OSUT	AN
<b>081-831-1033</b>	Perform First Aid for an Open Head Wound	BCT/ OSUT	AN
<b>081-831-1034</b>	Perform First Aid for a Suspected Fracture	BCT/ OSUT	AN

<b>Army Warrior Training Plan</b>			
<i>Task Number</i>	<i>Title</i>	<i>Training Location</i>	<i>Sustainment Training Frequency</i>
<b>Subject Area 2. First Aid</b>			
<b>081-831-1044</b>	Perform First Aid for Nerve Agent Injury	BCT/ OSUT	AN
<b>081-831-1045</b>	Perform First Aid for Cold Injuries	BCT/ OSUT	AN
<b>081-831-1046</b>	Transport a Casualty	BCT/ OSUT	AN
<b>081-831-1053</b>	Practice Individual Preventive Medicine Countermeasures	BCT/ OSUT	AN
<b>Subject Area 3. Chemical, Biological, Radiological, and Nuclear (CBRN)</b>			
<b>031-503-1013</b>	Decontaminate Yourself and Individual Equipment Using Chemical Decontaminating Kits	BCT/ OSUT	AN
<b>031-503-1015</b>	Protect Yourself from Chemical, Biological, Radiological, and Nuclear (CBRN) Injury or Contamination with Mission-Oriented Protective Posture (MOPP) Gear	BCT/ OSUT	AN
<b>031-503-1018</b>	React to Nuclear Hazard/Attack	BCT/ OSUT	AN
<b>031-503-1019</b>	React to Chemical or Biological (CB) Hazard/Attack	BCT/ OSUT	AN
<b>031-503-1024</b>	Replace Canister on Your M40-Series Protective Mask	BCT/ OSUT	AN
<b>031-503-1035</b>	Protect Yourself from Chemical and Biological (CB) Contamination Using Your Assigned Protective Mask	BCT/ OSUT	AN
<b>031-503-1036</b>	Maintain Your Assigned Protective Mask	BCT/ OSUT	AN

**Army Warrior Training Plan**

<i>Task Number</i>	<i>Title</i>	<i>Training Location</i>	<i>Sustainment Training Frequency</i>
<b>Subject Area 3. Chemical, Biological, Radiological, and Nuclear (CBRN)</b>			
<b>031-503-1037</b>	Detect Chemical Agents Using M8 or M9 Detector Paper	BCT/ OSUT	AN
<b>031-503-1040</b>	Protect Yourself from CBRN Injury/Contamination with the JSLIST Chemical-Protective Ensemble	BCT/ OSUT	SA
<b>031-503-1042</b>	Protect yourself from CBRN Injury/Contamination when Changing MOPP (Using JLIST)	BCT/ OSUT	SA
<b>Subject Area 4. Survive (Combat Techniques)</b>			
<b>052-192-1269</b>	Detect Explosive-Hazard Indicators by Visual Means	BCT/ OSUT	AN
<b>071-000-0006</b>	React to Man-to-Man Contact	BCT/ OSUT	AN
<b>071-326-0502</b>	Move Under Direct Fire	BCT/ OSUT	SA
<b>071-326-0503</b>	Move Over, Through, or Around Obstacles (Except Minefields)	BCT/ OSUT	SA
<b>071-326-0510</b>	React to Indirect Fire While Dismounted	BCT/ OSUT	SA
<b>071-326-0511</b>	React to Flares	BCT/ OSUT	SA
<b>071-326-0513</b>	Select Temporary Fighting Positions	BCT/ OSUT	SA
<b>071-326-0541</b>	Perform Movement Techniques During an Urban Operation	BCT/ OSUT	AN
<b>071-326-0542</b>	Enter a Building During an Urban Operation	BCT/ OSUT	AN
<b>071-326-3002</b>	React to Indirect Fire While Mounted	BCT/ OSUT	AN

<b>Army Warrior Training Plan</b>			
<i>Task Number</i>	<i>Title</i>	<i>Training Location</i>	<i>Sustainment Training Frequency</i>
<b>Subject Area 4. Survive (Combat Techniques)</b>			
<b>071-410-0002</b>	React to Direct Fire While Mounted	UNIT	SA
<b>093-401-5040</b>	React to Unexploded Ordnance Hazards	UNIT	SA
<b>171-137-0001</b>	Search Vehicles in a Tactical Environment	UNIT	SA
<b>191-376-5140</b>	Search a Vehicle for Explosive Devices or Prohibited Items at an Installation Access Control Point	UNIT	SA
<b>191-376-5141</b>	Search a Commercial Vehicle for Explosive Devices or Prohibited Items at an Installation Access Control Point	UNIT	SA
<b>191-376-5151</b>	Control Access to a Military Installation	UNIT	SA
<b>551-721-1359</b>	Operate a Vehicle in a Convoy	UNIT	SA
<b>Subject Area 5. Navigate</b>			
<b>061-283-1001</b>	Determine Direction Within the Target Area	BCT/ OSUT	AN
<b>071-329-1000</b>	Identify Topographic Symbols on a Military Map	BCT/ OSUT	AN
<b>071-329-1001</b>	Identify Terrain Features on a Map	BCT/ OSUT	AN
<b>071-329-1002</b>	Determine the Grid Coordinates of a Point on a Military Map	BCT/ OSUT	AN
<b>071-329-1003</b>	Determine a Magnetic Azimuth Using a Lensatic Compass	BCT/ OSUT	AN
<b>071-329-1004</b>	Determine the Elevation of a Point on the Ground Using a Map	BCT/ OSUT	AN

**Army Warrior Training Plan**

<i>Task Number</i>	<i>Title</i>	<i>Training Location</i>	<i>Sustainment Training Frequency</i>
--------------------	--------------	--------------------------	---------------------------------------

**Subject Area 5. Navigate**

<b>071-329-1005</b>	Determine a Location on the Ground by Terrain Association	BCT/ OSUT	AN
<b>071-329-1006</b>	Navigate from One Point on the Ground to Another Point While Dismounted	BCT/ OSUT	SA
<b>071-329-1008</b>	Measure Distance on a Map	BCT/ OSUT	AN
<b>071-329-1009</b>	Convert Azimuths	BCT/ OSUT	AN
<b>071-329-1011</b>	Orient a Map Using a Lensatic Compass	UNIT	AN
<b>071-329-1012</b>	Orient a Map to the Ground by Map-Terrain Association	BCT/ OSUT	AN
<b>071-329-1014</b>	Locate an Unknown Point on a Map and on the Ground by Intersection	UNIT	AN
<b>071-329-1015</b>	Locate an Unknown Point on a Map and on the Ground by Resection	BCT/ OSUT	AN
<b>071-329-1018</b>	Determine Direction Without a Compass	UNIT	AN
<b>071-329-1030</b>	Navigate From One Point on the Ground to Another Point While Mounted	UNIT	SA
<b>071-510-0001</b>	Determine Azimuths Using a Protractor	BCT/ OSUT	AN
<b>071-510-0002</b>	Compute Back Azimuths	BCT/ OSUT	AN

**Subject Area 6. Communicate**

<b>113-571-1022</b>	Perform Voice Communications	BCT/ OSUT	AN
<b>113-587-1064</b>	Prepare SINCGARS (Manpack) for Operation	BCT/ OSUT	SA
<b>113-587-2070</b>	Operate SINCGARS Single-Channel (SC)	BCT/ OSUT	SA



<b>Army Warrior Training Plan</b>			
<i>Task Number</i>	<i>Title</i>	<i>Training Location</i>	<i>Sustainment Training Frequency</i>
<b>Subject Area 6. Communicate</b>			
<b>113-600-2001</b>	Communicate Via a Tactical Telephone	UNIT	AN
<b>Subject Area 7. See</b>			
<b>071-331-0804</b>	Perform Surveillance Without the Aid of Electronic Devices	UNIT	SA
<b>071-730-0014</b>	Identify Combat Vehicles	UNIT	SA
<b>Subject Area 8. Hand Grenades and Land Mines</b>			
<b>071-325-4401</b>	Perform Safety Checks on Hand Grenades	BCT/ OSUT	AN
<b>071-325-4407</b>	Employ Hand Grenades	BCT/ OSUT	AN
<b>071-325-4425</b>	Employ an M18A1 Claymore Mine	BCT/ OSUT	AN
<b>071-325-4426</b>	Recover an M18A1 Claymore Mine	BCT/ OSUT	AN
<b>Subject Area 9. M16-Series Rifle</b>			
<b>071-311-2006</b>	Construct Field-Expedient Firing Aids for an M16A1/A2 Rifle	BCT/ OSUT	AN
<b>071-311-2007</b>	Engage Targets with an M16-Series Rifle	BCT/ OSUT	SA
<b>071-311-2025</b>	Maintain an M16-Series Rifle	BCT/ OSUT	QT
<b>071-311-2026</b>	Perform a Function Check on an M16-Series Rifle	BCT/ OSUT	QT
<b>071-311-2027</b>	Load an M16-Series Rifle	BCT/ OSUT	QT
<b>071-311-2028</b>	Unload an M16-Series Rifle	BCT/ OSUT	QT
<b>071-311-2029</b>	Correct Malfunctions of an M16-Series Rifle	BCT/ OSUT	QT

**Army Warrior Training Plan**

<i>Task Number</i>	<i>Title</i>	<i>Training Location</i>	<i>Sustainment Training Frequency</i>
<b>Subject Area 10. M240B Machine Gun</b>			
<b>071-025-0001</b>	Maintain an M240B Machine Gun	BCT/ OSUT	QT
<b>071-025-0002</b>	Perform a Function Check on an M240B Machine Gun	BCT/ OSUT	QT
<b>071-025-0003</b>	Load an M240B Machine Gun	BCT/ OSUT	QT
<b>071-025-0004</b>	Unload an M240B Machine Gun	BCT/ OSUT	QT
<b>071-025-0005</b>	Correct Malfunctions of an M240B Machine Gun	BCT/ OSUT	QT
<b>071-025-0007</b>	Engage Targets with an M240B Machine Gun	BCT/ OSUT	SA
<b>071-025-0015</b>	Mount an M240B Machine Gun on an M122A1 Tripod	BCT/ OSUT	QT
<b>071-025-0016</b>	Dismount an M240B Machine Gun from an M122A1 Tripod	BCT/ OSUT	QT
<b>Subject Area 11. M249 Machine Gun</b>			
<b>071-010-0006</b>	Engage Targets with an M249 Machine Gun	BCT/ OSUT	SA
<b>071-312-4025</b>	Maintain an M249 Machine Gun	BCT/ OSUT	QT
<b>071-312-4026</b>	Perform a Function Check on an M249 Machine Gun	BCT/ OSUT	QT
<b>071-312-4027</b>	Load an M249 Machine Gun	BCT/ OSUT	QT
<b>071-312-4028</b>	Unload an M249 Machine Gun	BCT/ OSUT	QT
<b>071-312-4029</b>	Correct Malfunctions of an M249 Machine Gun	BCT/ OSUT	QT

<b>Army Warrior Training Plan</b>			
<i>Task Number</i>	<i>Title</i>	<i>Training Location</i>	<i>Sustainment Training Frequency</i>
<b>Subject Area 12. MK19 Machine Gun</b>			
<b>071-030-0001</b>	Maintain an MK19 Machine Gun	UNIT	QT
<b>071-030-0004</b>	Engage Targets with an MK19 Machine Gun	BCT/ OSUT	QT
<b>071-030-0005</b>	Load an MK19 Machine Gun	BCT/ OSUT	QT
<b>071-030-0006</b>	Unload an MK19 Machine Gun	BCT/ OSUT	QT
<b>071-030-0007</b>	Perform a Function Check on an MK19 Machine Gun	BCT/ OSUT	QT
<b>071-030-0008</b>	Correct Malfunctions of an MK19 Machine Gun	BCT/ OSUT	QT
<b>Subject Area 13. Caliber .50 M2 Machine Gun</b>			
<b>071-022-0001</b>	Maintain a Caliber .50 M2 Machine Gun	UNIT	QT
<b>071-022-0003</b>	Load a Caliber .50 M2 Machine Gun	BCT/ OSUT	QT
<b>071-022-0004</b>	Unload a Caliber .50 M2 Machine Gun	BCT/ OSUT	QT
<b>071-022-0005</b>	Correct Malfunctions of a Caliber .50 M2 Machine Gun	BCT/ OSUT	QT
<b>071-313-3454</b>	Engage Targets with a Caliber .50 M2 Machine Gun	BCT/ OSUT	SA
<b>Subject Area 14. M136 Launcher</b>			
<b>071-054-0001</b>	Prepare an M136 Launcher for Firing	BCT/ OSUT	AN
<b>071-054-0002</b>	Restore an M136 Launcher to Carrying Configuration	BCT/ OSUT	AN
<b>071-054-0003</b>	Perform Misfire Procedures on an M136 Launcher	BCT/ OSUT	AN
<b>071-054-0004</b>	Engage Targets with an M136 Launcher	BCT/ OSUT	AN

**Army Warrior Training Plan**

<i>Task Number</i>	<i>Title</i>	<i>Training Location</i>	<i>Sustainment Training Frequency</i>
<b>Subject Area 15. M203 Grenade Launcher</b>			
<b>071-311-2125</b>	Maintain an M203 Grenade Launcher	BCT/ OSUT	QT
<b>071-311-2126</b>	Perform a Function Check on an M203 Grenade Launcher	BCT/ OSUT	QT
<b>071-311-2127</b>	Load an M203 Grenade Launcher	BCT/ OSUT	SA
<b>071-311-2128</b>	Unload an M203 Grenade Launcher	BCT/ OSUT	SA
<b>071-311-2129</b>	Correct Malfunctions of an M203 Grenade Launcher	BCT/ OSUT	SA
<b>071-311-2130</b>	Engage Targets with an M203 Grenade Launcher	BCT/ OSUT	SA
<b>Subject Area 16. M4 Carbine</b>			
<b>071-100-0001</b>	Zero an M4 or M4A1 Carbine	BCT/ OSUT	SA
<b>071-100-0003</b>	Engage Targets with an M4 or M4A1 Carbine	BCT/ OSUT	SA
<b>071-100-0004</b>	Maintain an M4 or M4A1 Carbine	BCT/ OSUT	QT
<b>071-100-0005</b>	Perform Function Check on an M4 or M4A1 Carbine	BCT/ OSUT	QT
<b>071-100-0006</b>	Load an M4 or M4A1 Carbine	BCT/ OSUT	QT
<b>071-100-0007</b>	Unload an M4 or M4A1 Carbine	BCT/ OSUT	QT
<b>071-100-0008</b>	Correct Malfunction on an M4 or M4A1 Carbine	BCT/ OSUT	QT

<b>Army Warrior Training Plan</b>			
<i>Task Number</i>	<i>Title</i>	<i>Training Location</i>	<i>Sustainment Training Frequency</i>
<b>Subject Area 17. Sights, Night, Day, Aiming Devices</b>			
<b>071-008-0007</b>	Engage Targets with an M16-Series Rifle Using an AN/PAS-13-Series Thermal Weapon Sight	UNIT	AN
<b>071-008-0011</b>	Engage Targets with an M16-Series Rifle Using an AN/PAQ-4-Series Aiming Light	BCT/ OSUT	AN
<b>071-010-0002</b>	Mount a Night Vision Sight, AN/PVS-4, on an M249 Machine Gun	BCT/ OSUT	SA
<b>071-010-0003</b>	Dismount a Night Vision Sight, AN/PVS-4, from an M249 Machine Gun	BCT/ OSUT	SA
<b>071-010-0007</b>	Engage Targets with an M249 Machine Gun Using a Night Vision Sight, AN/PVS-4	BCT/ OSUT	SA
<b>071-010-0008</b>	Mount an AN/PAS-13 Thermal Weapon Sight on an M249 Machine Gun	BCT/ OSUT	SA
<b>071-010-0009</b>	Dismount an AN/PAS-13 Thermal Weapon Sight from an M249 Machine Gun	BCT/ OSUT	SA
<b>071-010-0011</b>	Engage Targets with an M249 Machine Gun Using an AN/PAS-13 Thermal Weapon Sight	BCT/ OSUT	SA
<b>071-022-0008</b>	Mount a Night Vision Sight, AN/TVS-5, on a Caliber .50 M2 Machine Gun	BCT/ OSUT	SA
<b>071-022-0009</b>	Dismount a Night Vision Sight, AN/TVS-5, from a Caliber .50 M2 Machine Gun	BCT/ OSUT	SA

**Army Warrior Training Plan**

<i>Task Number</i>	<i>Title</i>	<i>Training Location</i>	<i>Sustainment Training Frequency</i>
<b>Subject Area 17. Sights, Night, Day, Aiming Devices</b>			
<b>071-022-0017</b>	Mount an AN/PAS-13 Thermal Weapon Sight on a Caliber .50 M2 Machine Gun	BCT/ OSUT	SA
<b>071-022-0018</b>	Dismount an AN/PAS-13 Thermal Weapon Sight from a Caliber .50 Machine Gun	BCT/ OSUT	SA
<b>071-022-0020</b>	Engage Targets with a Caliber .50 M2 Machine Gun Using an AN/PAS-13 Thermal Weapon Sight	BCT/ OSUT	SA
<b>071-025-0027</b>	Mount an AN/PEQ-2A-Series Aiming Light on an M240B Machine Gun	BCT/ OSUT	AN
<b>071-025-0028</b>	Dismount an AN/PEQ-2A-Series Aiming Light from an M240B Machine Gun	BCT/ OSUT	AN
<b>071-025-0030</b>	Engage Targets with an M240B Machine Gun Using an AN/PEQ-2A-Series Aiming Light	BCT/ OSUT	SA
<b>071-030-0016</b>	Mount a Night Vision Sight, AN/TVS-5, on an MK19 Machine Gun	BCT/ OSUT	SA
<b>071-030-0017</b>	Dismount a Night Vision Sight, AN/TVS-5, from an MK19 Machine Gun	BCT/ OSUT	SA
<b>071-030-0019</b>	Engage Targets with an MK19 Machine Gun Using a Night Vision Sight, AN/TVS-5	BCT/ OSUT	SA
<b>071-100-0017</b>	Mount an AN/PAQ-4-Series Aiming Light on an M4 or M4A1 Carbine	BCT/ OSUT	AN
<b>071-100-0020</b>	Zero an AN/PAQ-4-Series Aiming Light to an M4 or M4A1 Carbine	BCT/ OSUT	AN

<b>Army Warrior Training Plan</b>			
<i>Task Number</i>	<i>Title</i>	<i>Training Location</i>	<i>Sustainment Training Frequency</i>
<b>Subject Area 17. Sights, Night, Day, Aiming Devices</b>			
071-705-0001	Maintain an M68 Sight	BCT/ OSUT	AN
071-705-0002	Operate an M68 Sight	BCT/ OSUT	AN
071-705-0003	Zero an M68 Sight	BCT/ OSUT	AN
071-705-0004	Boresight an M68 Sight	BCT/ OSUT	AN
<b>Subject Area 18. M-9 Pistol 9-mm</b>			
071-004-0001	Maintain an M9 Pistol	UNIT	SA
071-004-0003	Load an M9 Pistol	UNIT	SA
071-004-0004	Unload an M9 Pistol	UNIT	SA
071-004-0005	Correct Malfunctions of an M9 Pistol	UNIT	SA
071-004-0006	Engage Targets with an M9 Pistol	UNIT	SA
<b>Subject Area 19. Casualty Reporting and Handling</b>			
101-515-1997	Inter Isolated Remains (After Receiving Authorization)	BCT/ OSUT	AN
101-515-1998	Evacuate Isolated Remains	BCT/ OSUT	AN
101-515-1999	Recover Isolated Remains	BCT/ OSUT	AN
<b>Subject Area 20. Defense Measures</b>			
052-191-1361	Camouflage Yourself and Your Individual Equipment	BCT/ OSUT	QT
071-000-0005	Prepare a Range Card for a Machine Gun	UNIT	AN
071-326-0550	Prepare Positions for Individual and Crew-Served Weapons During an Urban Operation	BCT/ OSUT	SA
071-326-0557	Select Hasty Firing Positions During an Urban Operation	BCT/ OSUT	SA

**Army Warrior Training Plan**

<i>Task Number</i>	<i>Title</i>	<i>Training Location</i>	<i>Sustainment Training Frequency</i>
<b>Subject Area 20. Defense Measures</b>			
<b>071-326-0608</b>	Use Visual Signaling Techniques	BCT/ OSUT	AN
<b>071-326-5703</b>	Construct Individual Fighting Positions	BCT/ OSUT	AN
<b>071-331-0801</b>	Challenge Persons Entering Your Area	BCT/ OSUT	AN
<b>071-331-0815</b>	Practice Noise, Light, and Litter Discipline	BCT/ OSUT	AN
<b>071-331-0852</b>	Clear a Field of Fire	BCT/ OSUT	AN
<b>071-331-1004</b>	Perform Duty as a Guard	BCT/ OSUT	AN
<b>071-440-0028</b>	Engage Targets During an Urban Operation	BCT/ OSUT	AN
<b>191-376-4114</b>	Control Entry to and Exit from a Restricted Area	BCT/ OSUT	AN
<b>191-377-4254</b>	Search a Detainee	BCT/ OSUT	AN
<b>191-377-4256</b>	Guard Detainees	BCT/ OSUT	SA
<b>301-348-1050</b>	Report Information of Potential Intelligence Value	BCT/ OSUT	AN
<b>301-371-1000</b>	Report Intelligence Information	BCT/ OSUT	AN
<b>301-371-1050</b>	Implement Operations Security (OPSEC) Measures	UNIT	AN



**Chapter 3**  
**Warrior Skills Level 1 Tasks**

**SUBJECT AREA 1: INDIVIDUAL CONDUCT AND LAWS OF WAR**

---

**181-105-1001**

**Comply with the Law of War and the Geneva and Hague Conventions**

**Conditions:** You are a Soldier in the U.S. Army. As a Soldier, you must identify, understand, and comply with the provisions of the Law of War, including the Geneva and Hague Conventions. You must also identify any suspected or known violations of the Law of War and notify the appropriate authorities.

**Standards:** Identify, understand, and comply with the Law of War. Identify problems or situations that violate the policies and take appropriate action (including notifying appropriate authorities) so that expedient action may be taken to correct the problem or situation.

---

**Performance Steps**

1. Define the Customary Law of War.
  - a. Describe the purpose and result of the Customary Law of War.
  - b. Describe the relationship between the Customary Law of War and the Hague Convention of 1907 and the Geneva Convention of 1949.
2. Describe the basics of the Hague and Geneva Conventions.
3. Describe the United States' responsibilities to comply with the Hague and Geneva Conventions, and the Customary Law of War.
4. Describe the limitation on targets according to the Customary Law of War and Hague Conventions.
  - a. Describe the International Law's prohibition on intentionally targeting or attacking civilians.
  - b. Describe the Hague Regulations' prohibition on destroying or seizing enemy property unless demanded by military necessity.
  - c. Describe the Hague Regulations' provisions on attacking a military target or a place occupied by a combatant force.
  - d. Describe the Hague Regulations' prohibition against attacking an undefended town, village, dwellings, buildings or other such place.
    - (1) Define an undefended place according to the Hague Convention.
    - (2) Describe the effect of medical units, wounded and sick personnel, and police forces within the undefended place on the character or status of the undefended place.
  - e. Describe when attacking or bombarding defended places is permitted.

## Performance Steps

(1) Define a defended place.

(2) Describe the status (defended or undefended) of a city or town surrounded by detached defense positions.

f. Describe when attacking a military objective, including bombardment, is permitted.

g. Describe the relationship between military necessity versus unnecessary suffering or destruction.

h. Describe the protections given to buildings dedicated to religion, art, science, or charitable purposes, or historic monuments during an attack or bombardment.

i. Describe the effect on protected status given to buildings dedicated to religion, art, science, or charitable purposes, or historic monuments if these buildings are being used for military purposes.

j. Describe the protections given to hospitals and other places where the sick and wounded are collected during an attack or bombardment.

(1) Describe the effect on this protected status if enemy Soldiers are the sick or wounded inside these hospitals or medical areas.

(2) Describe the effect on this protected status if these hospitals or medical areas are being used for military purposes.

k. Describe what may be an illegal trick or method or treacherous act under the Law of War in regards to permissible targets.

l. Describe why illegal tricks or methods or treacherous acts are prohibited.

m. Describe the legality of incidental damage to surrounding buildings during an attack on a legitimate target.

5. Describe the Customary Law of War and Hague Regulations' prohibitions on using certain types of weapons.

a. Describe the Hague Regulations' prohibitions on employing arms, material, or projectiles designated to cause unnecessary suffering

b. Describe how a Soldier could violate the Law of War by using an issued weapon in an illegal manner.

c. Describe the Hague Regulations' prohibitions on using poison or poisoned weapons against human beings in war.

d. Describe the 1925 Geneva Protocol's prohibition on using asphyxiating, poisonous, or other gases and the prohibition of bacteriological methods of warfare in war.

e. Describe the 1925 Geneva Protocol's ban on using chemical weapons in war.

## Performance Steps

- (1) Describe the United States' prohibition on the first use in war of chemical weapons.
  - (2) Describe the United States' reservation to use chemical weapons against a State if that State fails to respect the Geneva Protocol's ban on using chemical weapons.
  - (3) Define a lethal chemical agent and described how this Geneva Protocol applies to a lethal chemical agent.
  - (4) Define an incapacitating chemical agent and described how this Geneva Protocol applies to an incapacitating chemical agent.
  - (5) Describe the United States' position that the Geneva Protocol allows the use of either chemical herbicides or riot control agents in war.
    - (a) Describe the United States' unilateral renouncement of first use of herbicides in war and exception to this policy.
    - (b) Describe the United States' policy regarding first use of riot control agents in war.
    - (c) Describe the requirement for Presidential approval prior to using herbicides or riot control agents in armed conflict.
  - (6) Describe the United States' position on the initial or retaliatory use of bacteriological methods of warfare.
  - (7) Describe the 1925 Geneva Protocol's position on using smoke and incendiary materials in war.
  - (8) Describe International Law's position on using nuclear weapons by air, sea, or land forces.
6. Describe the rules of the Customary Law of War and Geneva Convention of 1949 governing the humane treatment of persons taking no active role in hostilities.
- a. Define a noncombatant.
  - b. Define humane treatment.
  - c. Describe acts that are strictly prohibited against noncombatants
  - d. Describe humane treatment of prisoners of war.
    - (1) Describe how all captured persons are entitled to be treated as prisoners of war until their actual status is determined.
    - (2) Describe the requirement to evacuate all captured or detained persons to a detainee collection point.
    - (3) Describe who determines a captured or detained person's status.
    - (4) Describe the prohibition on using physical force, mental torture, or coercion to obtain information.
    - (5) Describe what information the 1949 Geneva Prisoner of War Convention requires a Prisoner of War to provide to his/her captor.
    - (6) Describe what actions a captor or detaining power may take against a prisoner of war who refuses to answer questions, and described the practical reasons for this policy.

## Performance Steps

- (7) Describe the required treatment of prisoners of war in regards to—
- (a) Daily food and living quarters.
  - (b) Medical care.
  - (c) Personal hygiene.
  - (d) Exercising or observing religious faith.
  - (e) Retention of personal property.
  - (f) Receiving and sending mail.
  - (g) Having a prisoner's representative.
  - (h) Maintaining a chain of command.
  - (i) Requirement to work.

(8) Describe a prisoner of war's responsibility to obey lawful camp rules and disciplinary actions that may be taken against the prisoner of war for violating these rules.

e. Describe humane treatment of the wounded and sick.

(1) Describe how Article 14 of the Geneva Convention for the Amelioration of the Condition of the Wounded and Sick in the Armed Forces in the Field (GWS) applies and what it provides regarding the prisoner of war status of wounded and sick belligerents who fall into enemy hands.

(2) Describe what GWS Article 12 provides regarding protecting and treating members of the Armed Forces who are wounded or sick.

(3) Describe the requirement to leave medical personnel and material behind to care for the wounded and sick.

(4) Describe the protections given to medical personnel.

(a) Describe how these protections apply to military medics.

(b) Describe how these protections apply to medical staff exclusively engaged in administering to medical units and establishments.

(c) Describe how these protections apply to chaplains attached to the Armed Forces.

(d) Describe how these protections apply to the staff of national Red Cross societies and other voluntary aid organizations.

(5) Describe the status of captured full-time medical personnel as prisoners of war or retained personnel.

(a) Describe the right of retained medical personnel to perform medical duties.

(b) Describe the rights and time limitation of the detaining power to retain full-time medical personnel under the Geneva Convention for the Amelioration of the Condition of the Wounded and Sick in the Armed Forces in the Field.

(c) Describe the requirement and procedures that the detaining power must follow to return retained medical personnel.

## Performance Steps

(d) Describe the concept of retained personnel under the Geneva Convention Relative to the Treatment of Prisoners of War.

(e) Describe the requirement of retained personnel to follow the captor's internal disciplinary system at the camp where they are detained.

(6) Describe the status and protection given to members of the Armed Forces specially trained to serve as hospital orderlies, nurses, or auxiliary stretcher bearers.

(a) Describe these individual's status as prisoners of war versus retained personnel.

(b) Describe these individuals' rights on returning to their own side.

(c) Describe these individual's rights regarding working or performing duties while in the prisoner of war camp.

(7) Describe the status and protections given to members of recognized aid societies of neutral countries which lend the assistance of their medical personnel and units to a party to the conflict.

(a) Describe the consent, authorization, and control mechanism required for these individuals to assist a party to the conflict.

(b) Describe the notification requirements necessary for these individuals to assist a party to the conflict.

(c) Describe the captor's right to detain these individuals and the requirement to return them to their own side.

(d) Describe the work these individuals may perform while detained.

(8) Describe the protected status of medical property, material, and equipment under the Geneva Convention for the Amelioration of the Condition of the Wounded and Sick in the Armed Forces in the Field.

(a) Describe the circumstances under which fixed medical establishments and mobile units of the medical service may be attacked.

(b) Describe the duty to ensure medical establishments and units are not situated near military objectives.

(c) Describe the relationship between protections given to medical establishments and incidental damage, injury, or death to patients or personnel.

(d) Describe the possible loss of its protected status if fixed medical establishments and mobile units are used to commit acts harmful to the enemy.

(e) Describe the requirement for the enemy to warn the medical establishment prior to the loss of its protected status.

(f) Describe that only after the enemy provides such warning, and the warning remains unheeded, will the medical establishment's protection lapse.

## Performance Steps

(g) Describe circumstances that do not deprive a medical unit or establishment of its protection.

(h) Describe whether medical personnel being armed and using these arms to defend themselves and the sick and wounded deprive the medical unit or establishment of its protection.

(i) Describe whether the medical unit or establishment being protected by a picket, sentries, or an escort in the absence of armed orderlies deprives the medical unit or establishment of its protection.

(j) Describe whether finding small arms and ammunition taken from the wounded and sick but not yet turned over to the proper service at the medical unit or establishment deprives the medical unit or establishment of its protection.

(k) Describe whether personnel from the medical unit or establishment providing humanitarian care to the civilian wounded or sick deprives the medical unit or establishment of its protection.

(l) Describe the provisions of the Geneva Convention for the Amelioration of the Condition of the Wounded and Sick in the Armed Forces in the Field on establishing hospital zones and localities in order to shield the wounded and sick from the impact of war.

(m) Describe the enemy's obligation to restore medical buildings to the other side and to return captured medical material, stores, and equipment.

(n) Describe the authority of a Commander to use medical buildings for other than medical purposes, in cases of urgent military necessity.

(o) Describe the private property status and the right of requisition of real and personal property of aid societies.

(p) Describe the protected status of medical aircraft.

(q) Define a medical aircraft.

(r) Describe the requirement for medical aircraft to fly at heights, times, and on routes specifically agreed upon between the conflicting parties.

(s) Describe the required protective markings that must be displayed on medical aircraft.

(t) Describe the prohibition against medical aircraft flying over enemy territory or enemy-occupied territory.

(u) Describe the requirement for medical aircraft to land upon request from the enemy.

(v) Describe the right of medical aircraft to continue the flight after examination by the enemy.

(w) Describe the prisoner of war status of the wounded and sick and the aircraft crew captured by the enemy after an involuntary landing of the medical aircraft because of mechanical failure or inclement weather.

## Performance Steps

(x) Describe the emblem or distinctive sign of the medical service of an Armed Force

(y) Describe what other medical service emblems are recognized by the Geneva Convention.

(z) Describe whether the Star of David, used by the State of Israel, is specifically recognized by the Geneva Conventions.

(aa) Describe when and where these medical service emblems must be displayed.

(ab) Describe what medical service emblems medical personnel are required to wear and where these emblems should be displayed.

(ac) Describe the requirement for medical personnel to carry a special identification card bearing the medical emblem.

(ad) Describe the circumstances under which medical personnel may be deprived of their insignia or identification cards or the right to wear the armband.

(ae) Describe the right of medical personnel to receive duplicate identification cards or to replace insignia if lost.

(af) Describe the medical service emblems that auxiliary stretcher bearers must wear and when they must wear these emblems.

(ag) Describe what information must be specified on the military identification documents of auxiliary stretcher bearers.

(ah) Describe what flag may be flown over medical units and establishments.

(ai) Describe what flags may be flown over captured medical units.

(aj) Describe the requirement for distinctive emblems indicating medical units and establishments to be clearly visible to the enemy land, air, or naval forces.

(ak) Describe what flags may be flown over medical units belonging to aid societies of neutral countries assisting a party to the conflict.

f. Describe the humane treatment of civilians.

(1) Describe the rights and protections given to the civilian population of the country in conflict under Article 27 of the Geneva Convention Relative to the Protection of Civilian Persons in Time of War.

(2) Describe the rights of civilians to be protected against all acts or threats of violence and against insults and public curiosity.

(3) Describe the rights of civilian women to be protected against attack, enforced prostitution, rape and other forms of sexual assault.

(4) Describe the right of an occupying force to enforce control and security measures and how commanders must ensure that all persons are treated humanely while enforcing control and security measures.

## Performance Steps

(5) Describe the right of civilians not to be subjected to medical or scientific experiments, or made the object of collective penalties or reprisals, or held hostage.

(6) Describe the right of civilians to have their property protected from pillage or looting.

(7) Describe the right of the occupying power to establish laws and to try and punish civilians for violation of these occupation laws.

7. Describe the responsibilities of U.S. Soldiers to obey the Law of War.

a. Describe how U.S. Soldiers are bound to obey all the rules of the Customary Law of War and the Hague and Geneva Conventions.

b. Describe how U.S. Soldiers may be court-martialed for violating these rules.

c. Describe how U.S. Soldiers may also be prosecuted for committing a war crime.

d. Define a Grave Breach of the Law of War.

(1) Describe what offenses may constitute a grave breach.

(2) Describe what disciplinary actions may be taken against U.S. Soldiers who commit grave breaches.

(3) Describe the statute of limitations on prosecuting a war crime.

(4) Describe the responsibilities of the United States, as a signatory of the Geneva Conventions, regarding a person who commits a grave breach.

e. Describe the responsibilities of the commander in regards to violations of the Law of War.

(1) Describe how the legal responsibility for the commission of a war crime can be placed on the Commander as well as the subordinate who actually commits the war crime.

(2) Describe the circumstances under which a commander may be prosecuted for the commission of a war crime.

f. Describe an unlawful order and a Soldier's responsibility toward an unlawful order

(1) Describe the applicability of a Soldier asserting the defense of "obeying superior orders" for the commission of a war crime.

(2) Describe whether a subordinate Soldier, who actually commits a war crime, is excused from prosecution if the commander is charged with the commission of the war crime.

(3) Describe the responsibility of a Soldier to disobey any order which requires the Soldier to commit criminal acts in violation of the Law of War

(4) Describe the responsibility of a Soldier to obey the rules of engagement and the potential consequences for violating the rules of engagement.

(5) Describe the responsibility of the Soldier to ask a superior for clarification of an order suspected to be criminal or unlawful.

g. Describe a Soldier's obligation to report violations of the Law of War.



**Performance Steps**

- (1) Describe the requirement of a Soldier to inform the chain of command of known or suspected violations of the Law of War.
- (2) Describe what other avenues or agencies are available for the Soldier to report known or suspected violations of the Law of War.
- (3) Describe when Soldiers should notify their chain of command or alternative agencies of known or suspected violations of the Law of War.

**Evaluation Preparation:** *Setup:* Evaluate this task at the end of Law of War training.

*Brief Soldier:* Tell the Soldier that he/she will be evaluated on his/her ability to identify, understand, and comply with the Law of War, including the Geneva and Hague Conventions. Tell the Soldier that he/she will also be evaluated on his/her ability to identify problems or situations that violate the Law of War and take appropriate action, including notifying appropriate authorities of suspected or actual violations of the Law of War, so that expedient action may be taken to correct the problem or situation.

Performance Measures	GO	NO GO
1. Defined the Customary Law of War.	_____	_____
a. Described the purpose and result of the Customary Law of War.		
b. Described the relationship between the Customary Law of War and the Hague Convention of 1907 and the Geneva Convention of 1949.		
2. Described the basics of the Hague and Geneva Conventions.	_____	_____
3. Described the United States' responsibilities to comply with the Hague and Geneva Conventions.	_____	_____
4. Described the limitation on targets according to the Customary Law of War and Hague Convention.	_____	_____
a. Described the International Law's prohibition on targeting or attacking civilians.		
b. Described the Hague Regulations' prohibition on destroying or seizing enemy property unless demanded by military necessity.		
c. Described the Hague Regulations' provisions on attacking a military target or a place occupied by a combatant force.		
d. Described the Hague Regulations' prohibition against attacking an undefended town, village, dwellings, buildings or other such place.		

Performance Measures	GO	NO GO
<p>(1) Defined an undefended place according to the Hague Convention.</p>		
<p>(2) Described the condition that must exist for a place to be considered undefended.</p>		
<p>(3) Described the effect of medical units, wounded and sick personnel, and police forces within the undefended place on the character or status of the undefended place.</p>		
<p>e. Described when attacking or bombarding defended places was permitted.</p>		
<p>(1) Defined a defended place.</p>		
<p>(2) Described the status (defended or undefended) of a city or town surrounded by detached defense positions.</p>		
<p>f. Described when attacking a military objective, including bombardment was permitted.</p>		
<p>g. Described the relationship between military necessity versus unnecessary suffering or destruction.</p>		
<p>h. Described the protection given to buildings dedicated to religion, art, science, or charitable purposes, or historic monuments during an attack or bombardment.</p>		
<p>(1) Described the effect on this protected status if these buildings were being used for military purposes.</p>		
<p>i. Described the protections given to hospitals and other places where the sick and wounded are collected during an attack or bombardment.</p>		
<p>(1) Described the effect on this protected status if enemy soldiers were the sick or wounded inside these hospitals or medical areas.</p>		
<p>(2) Described the effect on this protected status if these hospitals or medical areas were being used for military purposes.</p>		
<p>j. Described what may be an illegal trick or method or treacherous act under the Law of War in regards to permissible targets.</p>		
<p>(1) Described why illegal tricks or methods or treacherous acts are prohibited.</p>		
<p>k. Described the legality of incidental damage to surrounding buildings during an attack on a legitimate target.</p>		
<p>5. Described the Customary Law of War and Hague Regulations' prohibitions on using certain types of weapons.</p>	<p>_____</p>	<p>_____</p>

Performance Measures	GO	NO GO
<p><b>a.</b> Described the Hague Regulations' prohibitions on employing arms, material, or projectiles designated to cause unnecessary suffering.</p> <p><b>b.</b> Described how a Soldier could violate the Law of War by using an issued weapon in an illegal manner.</p> <p><b>c.</b> Described the Hague Regulations' prohibitions on using poison or poisoned weapons against human beings in war.</p> <p><b>d.</b> Described the 1925 Geneva Protocol's prohibition on using asphyxiating, poisonous, or other gases, and the prohibition of bacteriological methods of warfare in war.</p> <p><b>e.</b> Described the 1925 Geneva Protocol's ban on using chemical weapons in war.</p> <p style="padding-left: 40px;"><b>(1)</b> Described the United States' prohibition on the first use in war of chemical weapons.</p> <p style="padding-left: 40px;"><b>(2)</b> Described the United States' reservation to use chemical weapons against a State if that State fails to respect the Geneva Protocol's ban on using chemical weapons.</p> <p style="padding-left: 40px;"><b>(3)</b> Described how this Geneva Protocol applies to both lethal and incapacitating chemical agents.</p> <p style="padding-left: 40px;"><b>(a)</b> Defined what constitutes an incapacitating agent.</p> <p style="padding-left: 40px;"><b>(4)</b> Described the United States' position that the Geneva Protocol allows the use of either chemical herbicides or riot control agents in war.</p> <p style="padding-left: 40px;"><b>(a)</b> Described the United States' unilateral renouncement of first use of herbicides in war and exception to this policy.</p> <p style="padding-left: 40px;"><b>(b)</b> Described the United States' policy regarding first use of riot control agents in war.</p> <p style="padding-left: 40px;"><b>(c)</b> Described the requirement for Presidential approval prior to use of herbicides or riot control agents in armed conflict.</p> <p style="padding-left: 40px;"><b>(5)</b> Described the United States' position on the initial or retaliatory using bacteriological methods of warfare.</p> <p style="padding-left: 40px;"><b>(6)</b> Described the 1925 Geneva Protocol's position on using smoke and incendiary materials in war.</p> <p style="padding-left: 40px;"><b>(7)</b> Described International Law's position on using nuclear weapons by air, sea, or land forces.</p> <p><b>6.</b> Described the rules of the Customary Law of War and Geneva Convention of 1949 governing the humane treatment of noncombatants.</p>		

Performance Measures	GO	NO GO
<p>a. Defined a noncombatant.</p> <p>b. Defined humane treatment.</p> <p>c. Described acts that are strictly prohibited against noncombatants.</p> <p>d. Described humane treatment of prisoners of war.</p> <p>(1) Described how all captured persons are entitled to be treated as Prisoners of War until their actual status is determined.</p> <p>(2) Described the requirement to evacuate all captured or detained persons to a detainee collection point.</p> <p>(3) Described who determines a captured or detained person's status.</p> <p>(4) Described the Geneva Convention Relative to the Treatment of Prisoners of War prohibition on using physical force, mental torture, or coercion to obtain information.</p> <p>(5) Described what information the 1949 Geneva Prisoner of War Convention requires a Prisoner of War to provide to his/her captor.</p> <p>(6) Described what actions a captor or detaining power may take against a Prisoner of War who refuses to answer questions.</p> <p>(a) Described the practical reasons for this policy.</p> <p>(7) Described the required treatment of prisoners of war in regards to—</p> <p>(a) Daily food and living quarters.</p> <p>(b) Medical care.</p> <p>(c) Personal hygiene.</p> <p>(d) Exercising or observing religious faith.</p> <p>(e) Retention of personal property.</p> <p>(f) Receiving and sending mail.</p> <p>(g) Having a prisoners' representative.</p> <p>(h) Maintaining a chain of command.</p> <p>(i) Requirement to work.</p> <p>(8) Described a prisoner of war's responsibility to obey lawful camp rules and disciplinary actions that may be taken against the prisoner of war for violating these rules.</p> <p>e. Described the humane treatment of the wounded and sick.</p>		

Performance Measures	GO	NO GO
<p>(1) Described how Article 14 of the Geneva Convention for the Amelioration of the Condition of the Wounded and Sick in the Armed Forces in the Field applies and what it provides regarding the prisoner of war status of wounded and sick of a belligerent who falls into enemy hands.</p> <p>(2) Described what Article 12 of the Geneva Wounded and Sick Convention provides regarding protection and treatment of members of the Armed Forces who are wounded or sick.</p> <p>(3) Described the requirement to leave medical personnel and material behind to care for the wounded and sick.</p> <p>(4) Described the protections given to medical personnel.</p> <p>(a) Described how these protections apply to military medics.</p> <p>(b) Described how these protections apply to medical staff exclusively engaged in administering to medical units and establishments.</p> <p>(c) Described how these protections apply to Chaplains attached to the Armed Forces.</p> <p>(d) Described how these protections apply to the staff of national red cross societies and other voluntary aid organizations.</p> <p>(5) Described the status of captured full-time medical personnel as Prisoners of War or Retained Personnel.</p> <p>(a) Described the right of retained medical personnel to perform medical duties.</p> <p>(b) Described the rights and time limitation of the detaining power to retain full-time medical personnel under the UN Geneva Convention for the Amelioration of the Condition of the Wounded and Sick in the Armed Forces in the Field..</p> <p>(c) Described the requirement and procedures that the detaining power must follow to return retained medical personnel.</p> <p>(d) Described the relationship of the Geneva Convention Relative to Prisoners of War to retained personnel.</p> <p>(e) Described the requirement of retained personnel to follow the captor's internal disciplinary system at the camp where they are detained.</p> <p>(6) Described the status and protection given to members of the Armed Forces specially trained to employ as hospital orderlies, nurses, or auxiliary stretcher bearers.</p>		

Performance Measures	GO	NO GO
<p>(a) Described these individual's status as prisoners of war versus retained personnel.</p> <p>(b) Described these individual's rights regarding return to their own side.</p> <p>(c) Described these individual's rights regarding work or duties while in the prisoner of war camp.</p> <p>(7) Described the status and protections given to members of recognized aid societies of neutral countries which lend assistance of their medical personnel and units to a party to the conflict.</p> <p>(a) Describe the consent, authorization, and control mechanism required for these individuals to assist a party to the conflict.</p> <p>(b) Described the notification requirements necessary for these individuals to assist a party to the conflict.</p> <p>(c) Described the captor's right to detain these individuals and the requirement to return them to their own side.</p> <p>(d) Described the work these individuals may perform while detained.</p> <p>(8) Described the protected status of medical property, material and equipment under the Geneva Wounded and Sick Convention.</p> <p>(a) Described the circumstances under which fixed medical establishments and mobile units of the medical service may be attacked.</p> <p>(b) Described the duty to ensure medical establishments and units are not situated near military objectives.</p> <p>(c) Described the relationship between protections given to medical establishments and incidental damage, injury, or death to patients or personnel.</p> <p>(d) Described the possible loss of its protected status if fixed medical establishments and mobile units are used to commit acts harmful to the enemy.</p> <p>(e) Described the requirement for the enemy to warn the medical establishment prior to the loss of its protected status.</p> <p>(f) Described that only after the enemy provides such warning, and the warning remains unheeded, will the medical establishment's protection lapse.</p> <p>(g) Described circumstances that do not deprive a medical unit or establishment of its protection.</p>		

Performance Measures	GO	NO GO
<p>(h) Described whether medical personnel being armed and using these arms to defend themselves and the sick and wounded deprive the medical unit or establishment of its protection.</p> <p>(i) Described whether the medical unit or establishment being protected by a picket, sentries, or an escort in the absence of armed orderlies deprives the medical unit or establishment of its protection.</p> <p>(j) Described whether small arms and ammunition taken from the wounded and sick but not yet turned over to the proper service are found on the medical unit or establishment deprives the medical unit or establishment of its protection.</p> <p>(k) Described whether personnel from the medical unit or establishment providing humanitarian care to the civilian wounded or sick deprives the medical unit or establishment of its protection.</p> <p>(l) Described the provisions of the Geneva Wounded and Sick Convention on establishing hospital zones and localities in order to shield the wounded and sick from the impact of war.</p> <p>(m) Described the enemy's obligation to restore medical buildings to the other side and to return captured medical material, stores, and equipment.</p> <p>(n) Described the authority of a commander to use medical buildings for other than medical purposes, in cases of urgent military necessity.</p> <p>(o) Described the private property status and the right of requisition of real and personal property of aid societies.</p> <p>(p) Described the protected status of medical aircraft.</p> <p>(q) Defined a medical aircraft.</p> <p>(r) Described the requirement for medical aircraft to fly at heights, times, and on routes specifically agreed upon between the conflicting parties.</p> <p>(s) Described the required protective markings that must be displayed on medical aircraft.</p> <p>(t) Described the prohibition against medical aircraft flying over enemy territory or enemy-occupied territory.</p> <p>(u) Described the requirement for medical aircraft to land upon request from the enemy.</p>		

Performance Measures	GO	NO GO
<p>(v) Described the right of medical aircraft to continue the flight after examination from the enemy.</p> <p>(w) Described the prisoner of war status of the wounded and sick and the aircraft crew captured by the enemy after an involuntary landing of the medical aircraft because of mechanical failure or inclement weather.</p> <p>(x) Described the emblem or distinctive sign of the medical service of an Armed Force.</p> <p>(y) Described what other medical service emblems are recognized by the Geneva Convention.</p> <p>(z) Described whether the Star of David, used by the State of Israel, is specifically recognized by the Geneva Conventions.</p> <p>(aa) Described when and where these medical service emblems must be displayed.</p> <p>(ab) Described what medical service emblems medical personnel are required to wear and where these emblems should be displayed.</p> <p>(ac) Described the requirement for medical personnel to carry a special identification card bearing the medical emblem.</p> <p>(ad) Described the circumstances under which medical personnel may be deprived of their insignia or identification cards or the right to wear the armband.</p> <p>(ae) Described the right of medical personnel to receive duplicate identification cards or to replace insignia if lost.</p> <p>(af) Described the medical service emblems that auxiliary stretcher bearers must wear and when they must wear these emblems.</p> <p>(ag) Described what information must be specified on the military identification documents of auxiliary stretcher bearers.</p> <p>(ah) Described what flag may be flown over medical units and establishments.</p> <p>(ai) Described what flags may be flown over captured medical units.</p> <p>(aj) Described the requirement for distinctive emblems indicating medical units and establishments to be clearly visible to the enemy land, air, or naval forces.</p>		



Performance Measures	GO	NO GO
<p>(ak) Described what flags may be flown over medical units belonging to aid societies of neutral countries assisting a party to the conflict.</p>		
<p>f. Described the humane treatment of civilians.</p>		
<p>(1) Described the rights and protections given to the civilian population of the country in conflict under Article 27 of the Geneva Convention Relative to the Protection of Civilian Persons in Time of War.</p>		
<p>(2) Described the rights of civilians to be protected against all acts or threats of violence and against insults and public curiosity.</p>		
<p>(3) Described the rights of civilian women to be protected against attack, enforced prostitution, rape and other forms of sexual assault.</p>		
<p>(4) Described the right of an occupying force to enforce control and security measures and how commanders must ensure that all persons are treated humanely while enforcing control and security measures.</p>		
<p>(5) Described the right of civilians not to be subjected to medical or scientific experiments, or made the object of collective penalties or reprisals, or held hostage.</p>		
<p>(6) Described the right of civilians to have their property protected from pillage or looting.</p>		
<p>(7) Described the right of the occupying power to establish laws and to try and punish civilians for violation of these occupation laws.</p>		
<p>7. Described the responsibilities of U.S. Soldiers to obey the Law of War.</p>		
<p>a. Described how U.S. Soldiers are bound to obey all the rules of the Customary Law of War and the Hague and Geneva Conventions.</p>		
<p>b. Described how U.S. Soldiers may be court-martialed for violating these rules.</p>		
<p>c. Described how U.S. Soldiers may also be prosecuted for committing a war crime.</p>		
<p>d. Defined a Grave Breach of the Law of War.</p>		
<p>(1) Described what criminal offenses may constitute a Grave Breach.</p>		
<p>(2) Described what disciplinary actions may be taken against U.S. Soldiers who commit a grave breach.</p>		
<p>(3) Described the statute of limitations on prosecuting a war crime.</p>		

Performance Measures	GO	NO GO
<p>(4) Described the responsibilities of the United States, as a signatory of the Geneva Conventions, regarding a person who commits a grave breach.</p> <p>e. Described the responsibilities of the commander in regards to violations of the Law of War.</p> <p>(1) Described how the legal responsibility for the commission of a war crime can be placed on the commander as well as the subordinate who actually commits the war crime.</p> <p>(2) Described the circumstances under which a commander may be prosecuted for the commission of a war crime.</p> <p>f. Described a criminal order and a Soldier's responsibility toward a criminal order.</p> <p>(1) Described the applicability of a Soldier asserting the defense of "obeying a superior order" for the commission of a war crime.</p> <p>(2) Described whether a subordinate Soldier, who actually commits a war crime, is excused from prosecution if the commander is charged with the commission of the war crime.</p> <p>(3) Described the responsibility of a Soldier to disobey any order which requires the Soldier to commit criminal acts in violation of the Law of War.</p> <p>(4) Described the responsibility of a Soldier to obey the rules of engagement and the potential consequences for violating the rules of engagement.</p> <p>(5) Described the responsibility of the Soldier to ask a superior for clarification of an order presumed to be criminal or illegal.</p> <p>g. Described a Soldier's obligation to report violations of the Law of War.</p> <p>(1) Described the requirement of a Soldier to inform the chain of command of known or suspected violations of the Law of War.</p> <p>(2) Described what other avenues or agencies are available for the Soldier to report known or suspected violations of the Law of War.</p> <p>(3) Described when Soldiers should notify their chain of command or alternative agencies of known or suspected violations of the Law of War.</p>		

**Evaluation Guidance:** Refer to chapter 1, paragraph 1-9e, (1) and (2).

**References**

**Required:** AR 27-1, FM 27-2, FM 27-10, and TC 27-10-1

**Related:**

---

## 224-176-1425

### Interact with News Media

**Conditions:** In a field, military operations in urban terrain (MOUT), or garrison environment, interact with news media when public affairs practitioners are not present.

**Standards:** Identify the principles of interacting with the media.

#### Performance Steps

1. Determine whether you may participate in a media interview.
  - a. Follow prior guidance from your chain of command.
  - b. Use caution when expressing personal opinion.
    - (1) By Army regulation, Soldiers must have command approval to wear their uniform during media interviews, if the interview will be viewed or is viewable by the public because the public may mistakenly assume their opinions represent the Army's official position.
    - (2) Soldiers do not have to receive prior authorization to conduct a media interview if they are acting in an unofficial capacity and not in uniform.
2. Understand your role when interacting with the media.
  - a. Check identification or press credentials. If identification or press credentials are produced, continue with the interview. If identification or press credentials are not produced, refer the individual to your chain of command or public affairs representative.
  - b. Recognize your rights.
    - (1) You do not have to speak to the media.
    - (2) You do not have to answer all the questions.
    - (3) You control the length of the interview.
  - c. Maintain operations security (OPSEC). Do not discuss classified information.
  - d. Demonstrate good judgment and professionalism.
3. Know the guidelines for speaking with the media.
  - a. Think before you answer.
  - b. Tell the truth. You should not lie or intentionally mislead members of the media.
  - c. Discuss only things that you have direct responsibility for or have personal knowledge about. Speak at your level. You should discuss only matters for which you have direct knowledge.
  - d. Do not answer speculative (what if) or hypothetical questions.
  - e. Avoid jargon, acronyms, slang and technical terms.

## Performance Steps

- f. Answer the question with which you are most comfortable when asked multiple questions.
  - g. Keep remarks brief and concise.
  - h. Assume everything you say may be printed or broadcast.
  - i. Use "I" not "we" when stating your opinion.
  - j. If you do not know the answer to a question or cannot discuss it for a particular reason (for example, OPSEC, personal privacy, and so forth), say so. Avoid using "No comment."
4. Inform the chain of command of your interaction with the media.

**Evaluation Preparation:** *Setup:* Provide the Soldier with a realistic scenario of a simulated media interview situation. Use mock press credentials when necessary.

*Brief Soldier:* Tell the Soldier he/she is about to be interviewed by the media and the commander has encouraged his/her participation. Public affairs representatives are not present. Evaluate the Soldier on his/her ability to interact with the media.

Performance Measures	GO	NO GO
1. Checked media representative for identification and credentials.	___	___
2. Stated the three recognized rights when interacting with the media.	___	___
3. Maintained OPSEC throughout the interview.	___	___
4. Discussed subject areas related to direct responsibility and personal knowledge.	___	___
5. Stated answers while avoiding speculation.	___	___
6. Performed interview without using jargon, acronyms, slang, or technical terms.	___	___
7. Employed concise remarks.	___	___
8. Did not make "off-the-record" comments.	___	___
9. Stated answers; avoided "No comment" response.	___	___
10. Informed the chain of command of interaction with the media.	___	___

**Evaluation Guidance:** Refer to chapter 1, paragraph 1-9e, (1) and (2).

### References

**Required:** AR 360-1 and FM 46-1

**Related:**

---

## 331-202-1049

### Comply with the Requirements of the Code of Conduct

**Conditions:** Given a survival, evasion, resistance, and escape (SERE) situation or a captivity environment.

**Standards:** Act according to the standards presented in Articles I through VI of the Code of Conduct.

---

#### Performance Steps

1. Article I states "I am an American, fighting in the forces, which guard my country and our way of life. I am prepared to give my life in their defense."

**Explanation.** The Code applies to all members of the Armed Forces at all times, whether in active combat, in captivity, or in peacetime as a result of hostage situations and terrorist activities. Members of the Armed Forces have a duty to support U.S. interests and oppose U.S. enemies regardless of the circumstances.

2. Article II states "I will never surrender of my own free will. If in command, I will never surrender the members of my command while they still have the means to resist."

**Explanation.** Members of the Armed Forces may never surrender voluntarily. Soldiers are to avoid capture, even when isolated, and no longer able to inflict casualties on the enemy or defend himself. The means to evade is considered exhausted when escape is impossible. The means to resist is considered exhausted when further fighting would lead to the Soldier's death with no significant loss to the enemy.

3. Article III states "If I am captured, I will continue to resist by all means available. I will make every effort to escape and aid others to escape. I will accept neither parole nor special favors from the enemy."

**Explanation.** Members of the Armed Forces must understand that a captive situation is an extension of the battlefield and the enemy will use a variety of tactics to exploit prisoners of war (PWs) in disregard of the Geneva Convention of 1949 Relative to the Treatment of Prisoners of War (GPW). These tactics have included physical and mental harassment, general mistreatment and torture, medical neglect, and political indoctrination. The duty of a member of the Armed Forces to continue resistance to enemy exploitation by all means available is not lessened by the misfortune of capture.

4. Article IV states "If I become a prisoner of war, I will keep faith with my fellow prisoners. I will give no information or take part in any action which might be harmful to my comrades. If I am senior, I will take command. If not, I will obey the lawful orders of those appointed over me and will back them up in every way."

**Explanation.** Officers and noncommissioned officers will continue to carry out their responsibilities and to exercise their authority in captivity. Informing on fellow PWs is forbidden. PWs must especially avoid helping the enemy to identify fellow PWs who have information that is of value to the enemy. These PWs may be made to suffer coercive interrogation because of their knowledge.

---

## Performance Steps

5. Article V states "When questioned, should I become a prisoner of war, I am required to give name, rank, service number, and date of birth. I will evade answering further questions to the utmost of my ability. I will make no oral or written statements disloyal to my country and its allies or harmful to their cause."

**Explanation.** When questioned, a PW is required by the Geneva Conventions and the Code of Conduct, E.O. 10631, and is permitted by Uniform Code of Military Justice (UCMJ), to give name, rank, service number, and date of birth. Under the Geneva Conventions the enemy has no right to try to force a PW to provide any additional information. However, it is unrealistic to expect a PW to remain confined for years reciting only name, rank, service number, and date of birth. There are many PW camp situations in which certain types of conversation with the enemy are permitted. For example, a PW is allowed, but not required by the Code of Conduct, the UCMJ, or the Geneva Conventions to fill out a Geneva Conventions "capture card", to write letters home, and to communicate with captors on matters of health and welfare.

6. Article VI states "I will never forget that I am an American, fighting for freedom, responsible for my actions, and dedicated to the principles which made my country free. I will trust in my God and in the United States of America."

**Explanation.** A member of the Armed Forces remains responsible for personal actions at all times. Article VI is designed to assist members of the Armed Forces to fulfill their responsibilities and survive captivity with honor. The Code of Conduct, E.O. 10631, does not conflict with the UCMJ, and the latter continues to apply to each military member during captivity or other hostile detention. Soldiers, whether detainees or captives, can be assured that the U.S. Government will make every effort to obtain their earliest release. Faith in one's country and its way of life, faith in fellow detainees or captives, and faith in one's self are critical to surviving with honor and resisting exploitation.

---

**Evaluation Preparation:** *Setup:* Develop an exercise scenario based on wartime mission requirements (including geographical areas of deployment). The scenario should reflect enemy doctrine, capabilities, vulnerabilities, political and cultural aspects, and PW management procedures. Develop a control plan, which incorporates the risk assessment and instructions for controlling and evaluating the player unit. Develop and design intelligence information to be coordinated, synchronized, and released to bring the play on the intended path. Test the Soldier's individually on his/her ability to apply elements of the Code of Conduct in a SERE situation or in a captivity environment during the survival/evasion portion of the local major Army command (MACOM) battalion, company, or platoon field training exercise (FTX). Maximum combat realism should be applied to tactical exercises consistent with good safety practices. Using PW compounds and resistance training laboratories by other than USAJFKSWCS to teach Code of Conduct and SERE training is prohibited according to AR 350-30.

*Brief Soldier:* Brief the Soldier that the Code of Conduct provides him or her with a set of guiding principles, moral obligations, and professional ethics to survive and return home with honor from a SERE environment and is not to be interpreted as a set of inflexible laws. Tell the Soldier that he/she is required to comply with the guidelines set forth in the Code of Conduct and according to FM 3-05.71, chapters 2 and 13.

Performance Measures	GO	NO GO
1. Complied with Article I of the Code of Conduct.	___	___
2. Complied with Article II of the Code of Conduct.	___	___
3. Complied with Article III of the Code of Conduct.	___	___
4. Complied with Article IV of the Code of Conduct.	___	___
5. Complied with Article V of the Code of Conduct.	___	___
6. Complied with Article VI of the Code of Conduct.	___	___

**Evaluation Guidance:** Refer to chapter 1, paragraph 1-9e, (1) and (2).

### References

**Required:** AR 350-30 and FM 3-05.71

**Related:** AR 350-1, DODD 1300.7, FM 25-4, and GTA 21-3-10

## SUBJECT AREA 2: FIRST AID

### 081-831-1001

#### Evaluate a Casualty (Tactical Combat Casualty Care)

**Conditions:** You have a casualty who has signs/symptoms of an injury. Your unit may be under fire.

**Standards:** Evaluate the casualty following the correct sequence. Identify all life-threatening conditions and other serious wounds.

#### Performance Steps

**Note:** Tactical combat casualty care (TCCC) can be divided into three phases. The first is care under fire; the second is tactical field care; the third is combat casualty evacuation care. In the first, you are under hostile fire and are very limited as to the care you can provide. In the second, you and the casualty are relatively safe and no longer under effective hostile fire, and you are free to provide casualty care to the best of your ability. In the third, the care is rendered during casualty evacuation (CASEVAC).

#### WARNING

If a broken neck or back is suspected, do not move the casualty unless to save his/her life.

1. Perform care under fire.
  - a. Return fire as directed or required before providing medical treatment.
  - b. Determine if the casualty is alive or dead.

## Performance Steps

**Note:** In combat, the most likely threat to the casualty's life is from bleeding. Attempts to check for airway and breathing will expose the rescuer to enemy fire. Do not attempt to provide first aid if your own life is in imminent danger.

**Note:** In a combat situation, if you find a casualty with no signs of life—no pulse, no breathing—do NOT attempt to restore the airway. Do NOT continue first aid measures.

- c. Provide tactical care to the live casualty.

**Note:** Reducing or eliminating enemy fire may be more important to the casualty's survival than the treatment you can provide.

- (1) Suppress enemy fire.

- (2) Use cover or concealment (smoke).

- (3) Direct the casualty to return fire, move to cover, and administer self-aid (stop bleeding), if possible. If the casualty is unable to move and you are unable to move the casualty to cover and the casualty is still under direct enemy fire, have the casualty "play dead."

- (4) If the casualty is unresponsive, move the casualty, his/her weapon, and mission-essential equipment to cover, as the tactical situation permits.

- (5) Keep the casualty from sustaining additional wounds.

- (6) Reassure the casualty.

- d. Administer life-saving hemorrhage control.

- (1) Determine the relative threat of the tactical situation versus the risk of the casualty's bleeding to death.

- (2) If the casualty has severe bleeding from a limb or has suffered amputation of a limb, administer life-saving hemorrhage control by applying a tourniquet before moving the casualty. (See task 081-831-1032.)

- e. Transport the casualty, his/her weapon, and mission-essential equipment when the tactical situation permits.

- f. Recheck bleeding control measures as the tactical situation permits.

- 2. Perform tactical field care when no longer under direct enemy fire.



## Performance Steps

**Note:** Tactical field care is rendered by the individual when no longer under hostile fire. Tactical field care also applies to situations in which an injury has occurred during the mission but there has been no hostile fire. Available medical equipment is limited to that carried into the field by the individual Soldier.

### WARNING

If there are any signs of nerve agent poisoning, stop the evaluation, take the necessary protective measures, and begin first aid. (See task 081-831-1044.)

**Note:** In the following situations communicate the medical situation to the unit leader and ensure that the tactical situation allows for time to perform these steps before initiating any medical procedure.

**Note:** When evaluating and/or treating a casualty, seek medical aid as soon as possible. Do NOT stop treatment. If the situation allows, send another person to find medical aid.

a. Form a general impression of the casualty as you approach (extent of injuries, chance of survival).

**Note:** If a casualty is being burned, take steps to remove the casualty from the source of the burns before continuing evaluation and treatment. (See task 081-831-1007.)

b. Check for responsiveness.

(1) Ask in a loud, but calm, voice: "Are you okay?" Gently shake or tap the casualty on the shoulder.

(2) Determine the level of consciousness by using AVPU: A = Alert; V = responds to Voice; P = responds to Pain; U = Unresponsive.

**Note:** To check a casualty's response to pain, rub the breastbone briskly with a knuckle or squeeze the first or second toe over the toenail.

(3) If the casualty is conscious, ask where his/her body feels different than usual, or where it hurts. Skip steps 2c and 2d. Go to step 2e.

**Note:** If the casualty is conscious but is choking and cannot talk, stop the evaluation and begin treatment. (See task 081-831-1003.)

(4) If the casualty is unconscious, continue with step 2c.

c. Position the casualty and open the airway. (See task 081-831-1023.)

d. Assess for breathing and chest injuries.

(1) Look, listen, and feel for respiration. (See task 081-831-1023.)

**Note:** If the casualty is breathing, insert a nasopharyngeal airway (see task 081-831-1023) and place the casualty in the recovery position.

**Note:** On the battlefield, the cost of attempting cardiopulmonary resuscitation (CPR) on casualties with what are inevitably fatal injuries may result in additional lives lost as care is diverted from casualties with less severe injuries. Only in the case of nontraumatic disorders such as hypothermia, near drowning, or electrocution should CPR be considered prior to the CASEVAC phase.

(2) Expose the chest and check for equal rise and fall and for any wounds. (See task 081-831-1026.)

## Performance Steps

(a) If the casualty has a penetrating chest wound and is breathing or making an effort to breathe, stop the evaluation to apply an occlusive dressing.

(b) Monitor for increasing respiratory distress. If this occurs, decompress the chest on the same side as the injury. (See task 081-831-1026.)

(c) Position or transport with the affected side down, if possible.

e. Identify and control bleeding.

(1) Check for bleeding.

(a) Remove only the minimum amount of clothing to expose and treat injuries. Protect the casualty from the environment (heat and cold).

(b) Look for blood-soaked clothes.

(c) Look for entry and exit wounds.

(d) Place your hands behind the casualty's neck and pass them upward toward the top of the head. Note whether there is blood or brain tissue on your hands from the casualty's wounds.

(e) Place your hands behind the casualty's shoulders and pass them downward behind the back, the thighs, and the legs. Note whether there is blood on your hands from the casualty's wounds.

(2) If life-threatening bleeding is present, stop the evaluation and control the bleeding. Apply a tourniquet, field dressing, or an emergency trauma dressing, as appropriate. (See tasks 081-831-1025, 081-831-1026, 081-831-1032, and 081-831-1033.) Treat for shock, as appropriate. (See task 081-831-1005.)

*Note:* If a tourniquet was previously applied, consider converting it to a pressure dressing. (See task 081-831-1032.) Converting the tourniquet to a pressure dressing may save the casualty's limb if the tourniquet has not been in place for 6 hours.

(3) Dress all wounds, including exit wounds.

f. Check for fractures.

(1) Check for open fractures by looking for bleeding or a bone sticking through the skin.

(2) Check for closed fractures by looking for swelling, discoloration, deformity, or unusual body position.

(3) If a suspected fracture is present, stop the evaluation and apply a splint. (See task 081-831-1034.)

g. Check for burns.

(1) Look carefully for reddened, blistered, or charred skin. Also check for singed clothes.

(2) If burns are found, stop the evaluation and begin treatment. (See task 081-831-1007.)

h. Administer pain medications and antibiotics (the casualty's combat pill pack) to any Soldier wounded in combat.

*Note:* Each Soldier will be issued a combat pill pack before deploying on tactical missions.

## Performance Steps

i. Transport the casualty to the site where evacuation is anticipated. (See task 081-831-1046.)

3. Monitor an unconscious casualty during CASEVAC.

**Note:** CASEVAC refers to the movement of casualties aboard nonmedical vehicles or aircraft. Care is rendered while the casualty is awaiting pickup or is being transported. A Soldier accompanying an unconscious casualty should monitor the casualty's airway, breathing, and bleeding.

**Evaluation Preparation:** *Setup:* Prepare a "casualty" for the Soldier to evaluate in step 2 by simulating one or more wounds or conditions. Simulate the wounds using a war wounds moulage set, casualty simulation kit, or other available materials. You can coach a "conscious casualty" on how to respond to the Soldier's questions about location of pain or other symptoms of injury. However, you will have to cue the Soldier during evaluation of an "unconscious casualty" as to whether the casualty is breathing and describe the signs or conditions as the Soldier is making the checks.

*Brief Soldier:* To test step 1, tell the Soldier that his/her unit is under fire and ask him/her what he/she should do to provide aid to casualties. For step 2, tell the Soldier that the tactical situation permits full evaluation of the casualty. Tell him/her to do, in order, all necessary steps to evaluate the casualty and identify all wounds and/or conditions. Tell the Soldier that he/she will not perform first aid but will **tell** you what first aid action (give mouth-to-mouth resuscitation, bandage the wound, and so forth) he/she would take. After he/she has completed the checks (step 2f), ask him/her what else he/she should do. To test step 3, ask him/her what he/she should do while evacuating an unconscious casualty.

Performance Measures	GO	NO GO
1. Performed care under fire.	_____	_____
a. Suppressed enemy fire to keep the casualty from sustaining additional wounds.		
b. Encouraged responsive casualties to protect themselves and perform self-aid, if able.		
c. Administered life-saving hemorrhage control.		
d. Transported the casualties, weapons, and mission-essential equipment, when the tactical situation permitted.		
2. Performed tactical field care.	_____	_____
a. Checked for responsiveness.		
b. Positioned the casualty and opened the airway.		
c. Assessed for breathing and chest injuries.		
d. Identified and controlled bleeding.		
e. Checked for fractures.		
f. Checked for burns.		

Performance Measures	GO	NO GO
g. Administered pain medications and antibiotics, if appropriate.		
h. Transported the casualty to the site where evacuation is anticipated.		
3. Monitored an unconscious casualty's airway, breathing, and bleeding during casualty evacuation.	_____	_____
4. Performed all necessary steps in sequence.	_____	_____
5. Identified all wounds and/or conditions.	_____	_____

**Evaluation Guidance:** Refer to chapter 1, paragraph 1-9e, (1) and (2).

**References**

**Required:**

**Related:** FM 4-25.11

## 081-831-1003

### Perform First Aid to Clear an Object Stuck in the Throat of a Conscious Casualty

**Conditions:** You see a conscious casualty who is having a hard time breathing because something is stuck in his/her throat.

**Standards:** Clear the object from the casualty's throat. Give abdominal or chest thrusts until the casualty can talk and breathe normally, you are relieved by a qualified person, or the casualty becomes unconscious requiring mouth-to-mouth resuscitation.

#### Performance Steps

1. Determine if the casualty needs help.

a. If the casualty has a mild airway obstruction (able to speak or cough forcefully, may be wheezing between coughs), do not interfere except to encourage the casualty.

b. If the casualty has a severe airway obstruction (poor air exchange and increased breathing difficulty, a silent cough, cyanosis, or inability to speak or breathe), continue with step 2.

**Note:** You can ask the casualty one question, "Are you choking?" If the casualty nods yes, help is needed.

2. Perform abdominal or chest thrusts.

**Note:** Abdominal thrusts should be used unless the victim is in the advanced stages of pregnancy, is very obese, or has a significant abdominal wound.

**Note:** Clearing a conscious casualty's airway obstruction can be performed with the casualty either standing or sitting.

a. Abdominal thrusts.

## Performance Steps

- (1) Stand behind the casualty.
- (2) Wrap your arms around the casualty's waist.
- (3) Make a fist with one hand.
- (4) Place the thumb side of the fist against the abdomen slightly above the navel and well below the tip of the breastbone.
- (5) Grasp the fist with the other hand.
- (6) Give quick backward and upward thrusts.

**Note:** Each thrust should be a separate, distinct movement. Thrusts should be continued until the obstruction is expelled or the casualty becomes unconscious.

**b.** Chest thrusts.

- (1) Stand behind the casualty.
- (2) Wrap your arms under the casualty's armpits and around the chest.
- (3) Make a fist with one hand.
- (4) Place the thumb side of the fist on the middle of the breastbone.
- (5) Grasp the fist with the other hand.
- (6) Give backward thrusts.

**Note:** Each thrust should be performed slowly and distinctly with the intent of relieving the obstruction.

**3.** Continue to give abdominal or chest thrusts, as required. Give abdominal or chest thrusts until the obstruction is clear, you are relieved by a qualified person, or the casualty becomes unconscious.

**Note:** If the casualty becomes unconscious, lay him/her down and then start mouth-to-mouth resuscitation procedures. (See task 081-831-1023.)

**4.** If the obstruction is cleared, watch the casualty closely and check for other injuries, if necessary.

---

**Evaluation Preparation:** *Setup:* You need another Soldier to play the part of the casualty.

*Brief Soldier:* Describe the symptoms of a casualty with a mild or severe airway obstruction. Ask the Soldier what should be done. Score step 1 based on the answer. Tell the Soldier to do all of the first aid steps required to clear an object from the casualty's throat. Tell the Soldier to demonstrate where to stand, how to position his/her hands, and how to position the casualty for the thrusts. The Soldier must tell you how the thrusts should be done. Ensure that the Soldier understands that he/she must not actually do the thrusts. Do not evaluate steps 3 and 4 in the simulated mode.

Performance Measures	GO	NO GO
1. Determined if the casualty needed help.	_____	_____
2. Performed abdominal or chest thrusts, as required.	_____	_____
a. Positioned hands correctly for the thrusts.		
b. Gave the thrusts properly.		

Performance Measures	GO	NO GO
3. Continued abdominal or chest thrusts, as required.	_____	_____
4. If the obstruction was cleared, watched the casualty closely and checked for other injuries, if necessary.	_____	_____

**Evaluation Guidance:** Refer to chapter 1, paragraph 1-9e, (1) and (2).

**References**

**Required:**

**Related:** FM 4-25.11

## 081-831-1005

### Perform First Aid to Prevent or Control Shock

**Conditions:** You see a casualty who is breathing. There is no uncontrolled bleeding. The casualty has one or more of the symptoms of shock. You will need a field jacket and blanket or poncho.

**Standards:** Attempt to prevent a casualty from going into shock by correctly positioning the casualty, loosening binding clothes, calming and reassuring the casualty, and providing shade from direct sunlight during hot weather or covering to prevent body heat loss during cold weather. Do not cause further injury to the casualty.

#### Performance Steps

1. Check the casualty for signs and symptoms of shock.
  - a. Sweaty but cool skin.
  - b. Pale skin.
  - c. Restlessness or nervousness.
  - d. Thirst.
  - e. Severe bleeding.
  - f. Confusion.
  - g. Rapid breathing.
  - h. Blotchy blue skin.
  - i. Nausea and/or vomiting.
2. Position the casualty.
  - a. Move the casualty to cover, if cover is available and the situation permits.
  - b. Lay the casualty on his/her back unless a sitting position will allow the casualty to breathe easier.

## Performance Steps

c. Elevate the casualty's feet higher than the heart using a stable object so the feet will not fall.

### WARNING

If the casualty has an unsplinted fractured or broken leg, an abdominal wound, or a head wound, do not elevate the casualty's legs.

3. Loosen clothing at the neck, waist, or anywhere it is binding.

### WARNING

Do not loosen clothing if in a chemical area.

4. Prevent the casualty from getting chilled or overheated.

a. Cover the casualty to avoid loss of body heat and, in cold weather, place cover under as well as over the casualty. Use a blanket or clothing, or improvise a cover.

b. Place the casualty under a permanent or improvised shelter in hot weather to shade him/her from direct sunlight.

### WARNING

Do not give the casualty anything to eat or drink.

5. Calm and reassure the casualty.

a. Take charge and show self-confidence.

b. Assure the casualty that he/she is being taken care of.

### WARNING

If you must leave the casualty, turn his/her head to the side to prevent choking if vomiting occurs.

6. Watch the casualty closely for life-threatening conditions and check for other injuries, if necessary. Seek medical aid.

**Evaluation Preparation:***Setup:* You will need another Soldier to play the part of the casualty. Have the casualty lie down. You can have a canteen of water available and have the casualty say that he/she is thirsty while testing step 3.

*Brief Soldier:* Tell the Soldier to do all necessary first aid steps to prevent shock. You can vary the test by telling the Soldier whether it is hot or cold or that the casualty has a broken leg or abdominal wound to see if the Soldier knows what to do. Do not evaluate step 5 in the simulated mode.

Performance Measures	GO	NO GO
1. Positioned the casualty correctly.	_____	_____
2. Loosened tight or binding clothes.	_____	_____

Performance Measures	GO	NO GO
3. Prevented the casualty from chilling or overheating.	_____	_____
4. Reassured the casualty.	_____	_____
5. Watched the casualty closely for life-threatening conditions and checked for other injuries, if necessary. Sought medical aid.	_____	_____

**Evaluation Guidance:** Refer to chapter 1, paragraph 1-9e, (1) and (2).

**References**

**Required:**

**Related:** FM 4-25.11

## 081-831-1007

### Perform First Aid for Burns

**Conditions:** You see a casualty who is suffering from a burn. You will need the casualty’s emergency trauma dressing or field dressing and canteen of water.

**Standards:** Give first aid for a burn without causing further injury to the casualty. Eliminate the source of the burn, if necessary. Apply a dressing lightly over the burn. Ensure that the sides of the dressing are sealed and the dressing does not slip.

#### Performance Steps

1. Eliminate the source of the burn.

a. Thermal burns. Remove the casualty from the source of the burn. If the casualty’s clothing is on fire, cover the casualty with a field jacket or any large piece of nonsynthetic material and roll him/her on the ground to put out the flames.

**CAUTION**

Synthetic materials, such as nylon, may melt and cause further injury.

b. Electrical burns. If the casualty is in contact with an electrical source, turn the electricity off, if the switch is nearby. If the electricity cannot be turned off, use any nonconductive material (rope, clothing, or dry wood) to drag the casualty away from the source.

**WARNING**

Do not touch the casualty or the electrical source with your bare hands. You will be injured too!

**WARNING**

High voltage electrical burns from an electrical source or lightning may cause temporary unconsciousness, difficulties in breathing, or difficulties with the heart (irregular heartbeat).



## Performance Steps

- c. Chemical burns.

### WARNING

Blisters caused by a blister agent are actually burns. Do not try to decontaminate skin where blisters have already formed. If blisters have not formed, decontaminate the skin.

- (1) Remove liquid chemicals from the burned casualty by flushing with as much water or other nonflammable fluid as possible.
  - (2) Remove dry chemicals by carefully brushing them off with a clean, dry cloth. If large amounts of water are available, flush the area. Otherwise, do not apply water.
  - (3) Smother burning white phosphorus with water, a wet cloth, or wet mud. Keep the area covered with the wet material.
- d. Laser burns. Move the casualty away from the source while avoiding eye contact with the beam source. If possible, wear appropriate laser eye protection.

*Note:* After the casualty has been removed from the source of the burn, continually monitor the casualty for conditions that may require basic lifesaving measures.

2. Uncover the burn.

### WARNING

Do NOT uncover the wound in a chemical environment. Exposure could cause additional harm.

- a. Cut clothing covering the burned area.

### WARNING

Do NOT attempt to remove clothing that is stuck to the wound. Additional harm could result.

- b. Gently lift away clothing covering the burned area.

### CAUTION

Do not pull clothing over the burns.

- c. If the casualty's hand(s) or wrist(s) have been burned, remove jewelry (rings, watches) and place them in his/her pockets.
3. Apply the casualty's dressing to the burn.

*Note:* If the burn is caused by white phosphorus, the dressing must be wet.

### CAUTION

Do not place the dressing over the face or genital area.  
Do not break the blisters.  
Do not apply grease or ointments to the burns.

## Performance Steps

- a. Apply the dressing/pad, white side down, directly over the wound.
- b. Wrap the tails (or the elastic bandage) so that the dressing/pad is covered and both sides are sealed.
- c. For a field dressing, tie the tails into a nonslip knot over the outer edge of the dressing, not over the wound. For an emergency trauma dressing, secure the hooking ends of the closure bar into the elastic bandage.
- d. Check to ensure that the dressing is applied lightly over the burn but firmly enough to prevent slipping.

**Note:** Electricity often leaves entry and exit burns. Both burns should be treated.

**Note:** If the casualty is conscious and not nauseated, give him/her small amounts of water to drink.

4. Watch the casualty closely for life-threatening conditions, check for other injuries (if necessary), and treat for shock. Seek medical aid.

**Evaluation Preparation:** *Setup:* You will need another Soldier to play the part of the casualty. Simulate the burn(s) by marking the casualty's body with a suitable material. Provide materials appropriate for the burn being simulated (piece of rope, blanket, water, dressing, or clean cloth). If a dressing is used, use the same one repeatedly. If an electrical burn is being simulated, have the casualty lie on a piece of wire or rope and have enough materials available to treat two simulated burns.

*Brief Soldier:* Tell the Soldier what is burning the casualty and have the Soldier take appropriate action. After the Soldier completes step 1, tell the Soldier that the casualty is conscious and has no injuries other than burns. When testing step 2, you can vary the test by telling the Soldier that clothing is stuck to the burn or that a chemical environment exists. Do not evaluate step 4 in the simulated mode.

Performance Measures	GO	NO GO
1. Eliminated the source of the burn.	_____	_____
2. Uncovered the burn, unless clothing was stuck to the wound or in a chemical environment.	_____	_____
3. Applied the casualty's dressing.	_____	_____
a. Applied the dressing/pad directly over the wound.		
b. Covered the edges of the dressing/pad.		
c. Properly secured the bandage.		
d. Applied the dressing lightly over the burn but firmly enough to prevent slipping.		
4. Watched the casualty closely for life-threatening conditions, checked for other injuries (if necessary), and treated for shock. Sought medical aid.	_____	_____

**Evaluation Guidance:** Refer to chapter 1, paragraph 1-9e, (1) and (2).

## References

**Required:**

**Related:** FM 4-25.11

---

# 081-831-1008

## Perform First Aid for Heat Injuries

**Conditions:** You see a casualty who has signs and symptoms of a heat injury. The casualty has a full canteen of cool water.

**Standards:** Recognize the type of heat injury and give appropriate first aid.

### Performance Steps

1. Identify the type of heat injury.
  - a. Heat cramps symptoms.
    - (1) Cramping in the extremities (arms and legs).
    - (2) Abdominal (stomach) cramps.
    - (3) Excessive sweating.

*Note:* Thirst may or may not occur. Cramping can occur without the Soldier being thirsty.

- b. Heat exhaustion symptoms.
      - (1) Profuse sweating with pale, moist, cool skin.
      - (2) Headache.
      - (3) Weakness.
      - (4) Dizziness.
      - (5) Loss of appetite.
      - (6) Cramping.
      - (7) Nausea (with or without vomiting).
      - (8) Urge to defecate.
      - (9) Chills (gooseflesh).
      - (10) Rapid breathing.
      - (11) Tingling of the hands and/or feet.
      - (12) Confusion (not answering easy questions correctly).
    - c. Heatstroke symptoms.
      - (1) Red (flushed), hot, dry skin.
      - (2) Weakness.
      - (3) Dizziness.
      - (4) Confusion.
      - (5) Headache.
      - (6) Seizures.
      - (7) Nausea.
      - (8) Stomach pains or cramps.
      - (9) Respiration and pulse may be rapid and weak.
      - (10) Unconsciousness and collapse may occur suddenly.

## Performance Steps

2. Provide the proper first aid for the heat injury.

a. Heat cramps.

- (1) Monitor the mental status by asking simple questions, such as the date or the president's name.
- (2) Move the casualty to a cool, shady area or improvise shade if none is available.
- (3) Loosen the casualty's clothing unless in a chemical environment.
- (4) Have the casualty slowly drink at least one canteen of cool water.
- (5) Seek medical aid if the cramps continue.
- (6) Monitor the casualty for signs and symptoms of heat exhaustion.

b. Heat exhaustion.

- (1) Monitor mental status by asking simple questions.
- (2) Move the casualty to a cool, shady area or improvise shade if none is available.
- (3) Loosen or remove the casualty's clothing and boots, unless in a chemical environment.
- (4) Pour water on the casualty and fan him/her.

*Note:* Apply iced sheets, if available. (Sheets soaked in cold/icy water and placed directly onto the skin of the casualty will lower body temperature rapidly.)

- (5) Have the casualty slowly drink at least one canteen of cool water.
- (6) Elevate the casualty's legs.
- (7) Monitor the casualty until the symptoms are gone or medical aid arrives.

*Note:* If possible, the casualty should not participate in strenuous activity for the rest of the day.

- (8) Monitor the casualty for signs and symptoms of heatstroke.

c. Heatstroke.

### WARNING

Heatstroke is a medical emergency that may result in death if treatment is delayed. Start cooling measures immediately and continue while waiting for transportation and during evacuation.

- (1) Monitor the casualty's mental status by asking simple questions.
- (2) Move the casualty to a cool, shady area or improvise shade if none is available.
- (3) Loosen or remove the casualty's clothing and boots, unless in a chemical environment.
- (4) Spray or pour water on the casualty and fan him/her. (Apply iced sheets if available.)
- (5) Massage the casualty's arms and legs.
- (6) Elevate the casualty's legs.
- (7) If the casualty is conscious, have him/her slowly drink at least one canteen of cool water.

### Performance Steps

3. Watch the casualty closely for life-threatening conditions, check for other injuries, and seek medical aid.

**Evaluation Preparation:** *Setup:* None.

*Brief Soldier:* Describe to the Soldier the signs and/or symptoms of heat cramps, heat exhaustion, or heatstroke, and ask the Soldier what type of heat injury is indicated. Then ask the Soldier what should be done to treat the heat injury described. Do not evaluate step 3 in the simulated mode.

Performance Measures	GO	NO GO
1. Identified the type of heat injury.	_____	_____
2. Provided the proper first aid for the heat injury.	_____	_____
3. Watched the casualty closely for life-threatening conditions, checked for other injuries, and sought medical aid.	_____	_____

**Evaluation Guidance:** Refer to chapter 1, paragraph 1-9e, (1) and (2).

### References

**Required:**

**Related:** FM 4-25.11

## 081-831-1023

### Perform First Aid to Restore Breathing and/or Pulse

**Conditions:** You see an adult casualty who is unconscious and does not appear to be breathing. You are not in a combat situation or chemical environment. You will need a nasopharyngeal airway (NPA).

**Standards:** Take appropriate action, in the correct sequence, to restore breathing and, if necessary, restore the pulse. Continue until the casualty's breathing/pulse returns, a qualified person relieves you, a physician stops you, or you are too tired to continue.

### Performance Steps

1. Roll the casualty onto his/her back, if necessary, and place him/her on a hard, flat surface.

#### WARNING

The casualty should be carefully rolled as a whole, so the body does not twist.

- a. Kneel beside the casualty.
- b. Raise the near arm and straighten it out above the head.
- c. Adjust the legs so they are together and straight or nearly straight.
- d. Place one hand on the back of the casualty's head and neck.

## Performance Steps

- e. Grasp the casualty under the arm with the free hand.
  - f. Pull steadily and evenly toward yourself, keeping the head and neck in line with the torso.
  - g. Roll the casualty as a single unit.
  - h. Place the casualty's arms at his/her sides.
2. Open the airway.

**Note:** If foreign material or vomit is in the mouth, remove it as quickly as possible.

- a. Head-tilt/chin-lift method.

**CAUTION**

Do NOT use this method if a spinal or neck injury is suspected.

- (1) Kneel at the level of the casualty's shoulders.
- (2) Place one hand on the casualty's forehead and apply firm, backward pressure with the palm to tilt the head back.
- (3) Place the fingertips of the other hand under the bony part of the lower jaw and lift, bringing the chin forward.

**Note:** Do NOT use the thumb to lift.

**Note:** Do NOT completely close the casualty's mouth.

**CAUTION**

Do NOT press deeply into the soft tissue under the chin with the fingers.

- b. Jaw-thrust method.

**CAUTION**

Use this method if a spinal or neck injury is suspected.

**Note:** If you are unable to maintain an airway after the second attempt, use the head-tilt/chin-lift method.

- (1) Kneel above the casualty's head (looking toward the casualty's feet).
- (2) Rest your elbows on the ground or floor.
- (3) Place one hand on each side of the casualty's lower jaw at the angle of the jaw, below the ears.
- (4) Stabilize the casualty's head with your forearms.
- (5) Use the index fingers to push the angles of the casualty's lower jaw forward.

**Note:** If the casualty's lips are still closed after the jaw has been moved forward, use your thumbs to retract the lower lip and allow air to enter the casualty's mouth.

**CAUTION**

Do not tilt or rotate the casualty's head.

3. Check for breathing.

## Performance Steps

- a. While maintaining the open airway position, place an ear over the casualty's mouth and nose, looking toward the chest and stomach.
- b. Look for the chest to rise and fall.
- c. Listen for air escaping during exhalation.
- d. Feel for the flow of air on the side of your face.
- e. Count the number of respirations for 15 seconds.
- f. Take appropriate action.

(1) If the casualty is unconscious; if respiratory rate is less than 2 in 15 seconds, and/or if the casualty is making snoring or gurgling sounds, insert an NPA.

### CAUTION

Do NOT use the NPA if there is clear fluid (cerebrospinal fluid-CSF) coming from the ears or nose. This may indicate a skull fracture.

- (a) Keep the casualty in a face-up position.
- (b) Lubricate the tube of the NPA with water.
- (c) Push the tip of the casualty's nose upward gently.
- (d) Position the tube of the NPA so that the bevel (pointed end) of the NPA faces toward the septum (the partition inside the nose that separates the nostrils).

**Note:** Most NPAs are designed to be placed in the right nostril.

- (e) Insert the NPA into the nostril and advance it until the flange rests against the nostril.

### CAUTION

Never force the NPA into the casualty's nostril. If resistance is met, pull the tube out and attempt to insert it in the other nostril. If neither nostril will accommodate the NPA, place the casualty in the recovery position.

- (f) Place the casualty in the recovery position by rolling him/her as a single unit onto his/her side, placing the hand of his/her upper arm under his/her chin, and flexing his/her upper leg.
- (g) Watch the casualty closely for life-threatening conditions and check for other injuries, if necessary. Seek medical aid.

(2) If the casualty is not breathing, continue with step 4 if the tactical situation permits.

**Note:** If the casualty resumes breathing at any time during this procedure, the airway should be kept open and the casualty should be monitored. If the casualty continues to breathe, he/she should be transported to medical aid. Otherwise, the procedure should be continued.

4. Give breaths to ensure an open airway.

## Performance Steps

**Note:** When mouth-to-mouth resuscitation breathing cannot be performed because the casualty has jaw injuries or spasms, the mouth-to-nose method may be more effective. Perform the mouth-to-nose method as follows:

- Blow into the nose while holding the lips closed.
  - Let air escape by removing your mouth and, in some cases, separating the casualty's lips.
- a. Insert a face shield, if available, into the casualty's mouth, with the short airway portion over the top of the tongue, and flatten the plastic sheet around the mouth.
  - b. Maintain the airway and gently pinch the nose closed, using the hand on the casualty's forehead.
  - c. Take a normal breath and place your mouth, in an airtight seal, around the casualty's mouth.
  - d. Give two breaths (1 second each), taking a breath between them, while watching for the chest to rise and fall and listening and/or feeling for air to escape during exhalation.

**Note:** If the chest rises, go to step 7.

**Note:** If the chest does not rise after the first breath, continue with step 5.

5. Reposition the casualty's head slightly farther backward and repeat the breaths.

**Note:** If the chest rises, go to step 7.

**Note:** If the chest does not rise, continue with step 6.

6. Perform chest compressions to clear the airway.

- a. Perform chest compressions.
  - (1) Kneel close to the side of the casualty's body.
  - (2) Locate the nipple line placing the heel of one hand on the lower half of the sternum (breastbone).
  - (3) Place the heel of the other hand on top of the first hand on the lower half of the breastbone, extending or interlacing the fingers.
  - (4) Straighten and lock the elbows with the shoulders directly above the hands.
  - (5) Without bending the elbows, rocking, or allowing the shoulders to sag, apply enough pressure to depress the breastbone  $1\frac{1}{2}$  to 2 inches.

**Note:** Give compressions at a rate of 100 per minute (hard and fast at a ratio of 30 compressions to 2 breaths) with the intent of relieving the obstruction.

- b. Look in the mouth for the object between compressions and breaths and if you can see it, remove it.



**WARNING**

Only attempt to remove the object if you can see it.

Do NOT force the object deeper into the airway.

- c. Reopen the airway and repeat the breaths.

*Note:* If the chest rises, go to step 7.

*Note:* If the chest does not rise, repeat step 6 until the airway is clear.

- 7. Check for a pulse for 5 to 10 seconds.

*Note:* Use the first two fingers in the groove in the casualty's throat beside the Adam's apple on the side closest to you. Do NOT use the thumb.

- a. If a pulse is found but the casualty is not breathing, continue mouth-to-mouth resuscitation.

- (1) Give breaths at the rate of one every 5 to 6 seconds (10 to 12 breaths per minute).

- (2) Recheck for pulse and breathing every 2 minutes. If the pulse stops, go to step 8.

- (3) Continue until the casualty's breathing returns, a qualified person relieves you, a physician stops you, or you are too tired to continue. If the breathing returns, go to step 9.

- b. If no pulse is found, you must perform cardiopulmonary resuscitation (CPR). Continue with step 8.

- 8. Perform CPR.

- a. Position your hands and body for chest compressions as in step 6a.

- b. Give 30 compressions.

- (1) Press straight down to depress the breastbone 1 ½ to 2 inches.

- (2) Come straight up and completely release the pressure on the breastbone to allow the chest to return to its normal position. The time allowed for release should equal the time required for compression.

- (3) Give 30 compressions in about 23 seconds (at a rate of 100 per minute).

*Note:* Do NOT remove the heel of your hand from the casualty's chest or reposition your hand between compressions. However, all pressure must be released from the chest cavity to allow for full chest wall expansion.

- c. Give two breaths.

- (1) Open the casualty's airway.

- (2) Give two breaths (1 second each).

- d. Repeat steps 8b through 8c for five cycles or 2 minutes.

- e. Reassess the casualty.

- (1) Check for the return of the pulse for 3 to 5 seconds.

## Performance Steps

- (a) If the pulse is present, continue with step 8e(2).
  - (b) If the pulse is absent, continue with step 8f.
- (2) Check breathing for 3 to 5 seconds.
- (a) If the casualty is breathing, continue with step 9.
  - (b) If the casualty is not breathing, continue mouth-to-mouth resuscitation (step 7a).
- f. Resume CPR with compressions (step 8b).
  - g. Recheck for pulse every 2 minutes.
  - h. Continue CPR until the casualty's pulse returns, you are relieved by a qualified person, stopped by a physician, or you are too tired to continue.
9. Once the casualty is breathing and has a pulse, place the casualty in the recovery position until help arrives. Watch the casualty closely for life-threatening conditions, maintain an open airway, and check for other injuries, if necessary.

**Evaluation Preparation:** *Setup:* For training and testing, you must use a resuscitation training mannequin (DVC 08-15). Have a bottle of alcohol and swabs or cotton available. Place the mannequin on the floor and alcohol and cotton balls on the table. Clean the mannequin's nose and mouth before each Soldier is evaluated. If a mannequin that is capable of testing insertion of an NPA is available, use it to test step 3b.

*Brief Soldier:* Tell the Soldier to do, in order, all necessary steps to restore breathing and pulse. For step 3b, tell the Soldier that the casualty's breathing rate is slow, and have him/her show you (on a mannequin) or tell you what he/she would do to insert an NPA. After step 3, tell the Soldier that the casualty is not breathing. When testing steps 4 and 5, you can vary the test by indicating whether the chest rises or not. If steps 6 and 7 are tested, tell the Soldier that the chest rises after he/she removes the foreign object. When testing step 8, tell the Soldier that a pulse is not found. You can stop the evaluation when the Soldier rechecks for the pulse in step 10. Do not evaluate step 12 in the simulated mode.

**Note:** Reference made to the mouth-to-nose method within the task presents information on an alternate procedure that must be used under some circumstances. This method will not be evaluated.

Performance Measures	GO	NO GO
1. Positioned the casualty.	_____	_____
2. Opened the airway using the head-tilt/chin-lift method.	_____	_____
3. Checked for breathing.	_____	_____
a. Looked, listened, and felt for signs of respiration.		
b. Inserted an NPA, if necessary.		
4. Gave breaths to ensure an open airway.	_____	_____

Performance Measures	GO	NO GO
5. Repositioned the casualty's head and repeated breaths, if necessary.	_____	_____
6. Performed chest compressions to clear the airway, if necessary.	_____	_____
7. Looked for a foreign object in the casualty's mouth and removed it, if necessary. (Did NOT perform a blind finger sweep.)	_____	_____
8. Checked for a pulse.	_____	_____
9. Continued mouth-to-mouth or mouth-to-nose resuscitation or CPR, as required.	_____	_____
10. Rechecked for pulse and breathing, as required.	_____	_____
11. Performed all necessary steps in the correct sequence.	_____	_____
12. Once the casualty was breathing and had a pulse, placed him/her in the recovery position. Watched the casualty closely for life-threatening conditions, maintained an open airway, and checked for other injuries, if necessary.	_____	_____

**Evaluation Guidance:** Refer to chapter 1, paragraph 1-9e, (1) and (2).

#### References

#### Required:

**Related:** DVC 08-15 and FM 4-25.11

## 081-831-1025

### Perform First Aid for an Open Abdominal Wound

**Conditions:** You see a casualty who has an open abdominal wound. The casualty is breathing. You will need the casualty's emergency trauma dressing or field dressing and material for an improvised dressing (clothing or blankets).

**Standards:** Apply a dressing to the wound following the correct sequence, without causing further injury to the casualty. Ensure that the dressing is secure and protects the wound without putting pressure on the bowel.

#### Performance Steps

**Note:** Always check for both entry and exit wounds. If there are two wounds (entry and exit), treat the wound that appears more serious first (for example, the heavier bleeding, protruding organs, larger wound, and so forth). It may be necessary to improvise dressings for the second wound by using strips of cloth, a T-shirt, or the cleanest material available.

1. Position the casualty on his/her back with the knees up (flexed).
2. Uncover the wound unless clothing is stuck to the wound or you are in a chemical environment.

## Performance Steps

### CAUTION

Removing stuck clothing or uncovering the wound in a chemical environment could cause additional harm.

3. Pick up any organs that are on the ground.
  - a. Use a clean, dry dressing or the cleanest material available and gently pick up the organs without touching them with your bare hands.
  - b. Place the organs on top of the casualty's abdomen.

### CAUTION

Do NOT probe, clean, or try to remove any foreign object from the abdomen. Do NOT push organs back inside the body.

4. Apply the casualty's dressing.

**Note:** If the dressing is NOT large enough to cover the entire wound, the inner surface of the plastic wrapper from the dressing may be used to cover the bowel before the dressing is applied. Other improvised dressings can be made from clothing, blankets, or the cleanest material available.

### WARNING

If there is an object extending from the wound, do NOT remove it. Place as much of the wrapper over the wound as possible without dislodging or moving the object. Do NOT place the wrapper over the object.

- a. Apply the dressing/pad, white side down, directly over the wound.

### WARNING

Do NOT apply pressure to the wound or other exposed internal parts.

- b. Wrap the tails (or the elastic bandage) around the casualty's body, completely covering the dressing/pad if possible.
- c. For a field dressing, loosely tie the tails into a nonslip knot at the casualty's side. For an emergency trauma dressing, secure the hooking ends of the closure bar into the elastic bandage.
- d. Ensure that the dressing is secured firmly enough to prevent slipping, without applying pressure to the bowel.

**Note:** Dressings can be covered with improvised reinforcement materials (cravats, strips of torn cloth) for additional support and protection. The improvised bandages should be tied on the casualty's side—the side opposite to where the dressing is tied.

### WARNING

Do NOT give food or water to the casualty. (Moistening the casualty's lips is allowed.)

## Performance Steps

5. Watch the casualty closely for life-threatening conditions, check for other injuries (if necessary), and treat for shock. Seek medical aid.

**Evaluation Preparation:** *Setup:* Use the same dressing repeatedly. Have another Soldier act as the casualty. Use a moulage or otherwise simulate the abdominal wound. You can have a canteen of water available and have the casualty say that he/she is thirsty while testing step 4.

*Brief Soldier:* Tell the Soldier to do, in order, all necessary first aid steps to treat the casualty's wound. When testing step 2, you can vary the test by telling the Soldier that clothing is stuck to the wound or that a chemical environment exists. Do not evaluate step 6 in the simulated mode.

Performance Measures	GO	NO GO
1. Positioned the casualty on his/her back with the knees up (flexed).	_____	_____
2. Uncovered the wound unless clothing was stuck to the wound or a chemical environment existed.	_____	_____
3. Picked up organs without touching them with bare hands and placed them near the wound.	_____	_____
4. Applied the casualty's dressing. a. Applied the dressing/pad directly over the wound. b. Covered the edges of the dressing/pad. c. Properly secured the bandage. d. Secured the dressing firmly enough to prevent slipping without applying pressure to the bowel.	_____	_____
5. Performed steps 1 through 4 in the correct sequence.	_____	_____
6. Watched the casualty closely for life-threatening conditions, checked for other injuries (if necessary), and treated for shock. Sought medical aid.	_____	_____

**Evaluation Guidance:** Refer to chapter 1, paragraph 1-9e, (1) and (2).

### References

**Required:**

**Related:** FM 4-25.11

## 081-831-1026

### Perform First Aid for an Open Chest Wound

**Conditions:** You see a casualty who has an open chest wound. The casualty is breathing. You will need the casualty's emergency trauma dressing or field dressing, a large bore (14-gauge, 3-inch long) needle and catheter unit, and material to improvise a dressing (clothing or blankets).

**Standards:** Apply a dressing to the wound following the correct sequence, without causing further injury to the casualty. Ensure that the wound is properly sealed and the dressing is firmly secured without interfering with breathing. Perform needle chest decompression, if necessary.

**Performance Steps**

*Note:* Always check for both entry and exit wounds. If there are two wounds (entry and exit), treat the wound that appears more serious first (for example, the heavier bleeding, larger wound, and so forth). It may be necessary to improvise dressings for the second wound by using strips of cloth, a T-shirt, or the cleanest material available.

1. Uncover the wound unless clothing is stuck to the wound or you are in a chemical environment.

**CAUTION**

Removing stuck clothing or uncovering the wound in a chemical environment could cause additional harm.

**WARNING**

Do not attempt to clean the wound.

2. Apply airtight material over the wound.
  - a. Fully open the outer wrapper of the casualty’s dressing or other airtight material.
  - b. Place the inner surface of the outer wrapper or other airtight material directly over the wound after the casualty exhales completely.

*Note:* When applying the airtight material, do not touch the inner surface.

- c. Hold the material in place.
3. Apply the casualty’s dressing.
  - a. Apply the dressing/pad, white side down, directly over the airtight material.
  - b. Have the casualty breathe normally.
  - c. Maintain pressure on the dressing while you wrap the tails (or elastic bandage) around the body and back to the starting point.
  - d. For a field dressing, tie the tails into a nonslip knot over the center of the dressing after the casualty has exhaled completely. For an emergency trauma dressing, pass the tail through the plastic pressure device, reverse the tail while applying pressure, continue to wrap the tail around the body, and secure the plastic fastening clip to the last turn of the wrap.

- e. Ensure that the dressing is secured without interfering with breathing.

*Note:* When practical, apply direct manual pressure over the dressing for 5 to 10 minutes to help control the bleeding.

## Performance Steps

4. Position the casualty on the injured side or in a sitting position, whichever makes breathing easier.

### WARNING

If the casualty's respiratory condition becomes worse (rapid breathing, shortness of breath, restlessness, pale skin or bluish skin, pain in chest, or loss of consciousness) after placing the dressing on the wound, assume that a tension pneumothorax has developed, and perform needle chest decompression.

5. Perform needle chest decompression, if necessary.
  - a. Locate the insertion site. Locate the second intercostal space (between the second and third ribs about two finger widths below the collarbone) at the midclavicular line (approximately in line with the nipple) on the same side of the casualty's chest as the penetrating wound.
  - b. Insert a large bore (14-gauge, 3-inch long) needle and catheter unit.
    - (1) Firmly insert the needle into the skin over the top of the third rib into the second intercostal space, until the chest cavity has been penetrated, as evidenced by feeling a "pop" as the needle enters the chest cavity. A hiss of escaping air under pressure will usually be heard.

### WARNING

The needle must be positioned properly to avoid puncturing blood vessels and/or nerves. Blood vessels and nerves run along the bottom of each rib.

- (2) Withdraw the needle while holding the catheter in place. Secure the catheter to the chest wall with tape.
6. Watch the casualty closely for life-threatening conditions, check for other injuries (if necessary), and treat for shock. Seek medical aid.

**Evaluation Preparation:** *Setup:* Use the same dressing repeatedly. Prepare the dressing outer wrapper or provide a piece of airtight material (plastic, cellophane, foil). Have another Soldier act as the casualty. Use a moulage or otherwise simulate the chest wound. If a mannequin that is capable of testing needle chest decompression is available, use it to test step 6. Have an 18-gauge needle available.

*Brief Soldier:* Tell the Soldier to do, in order, all necessary first aid steps to treat the casualty's wound. When testing step 1, you can vary the test by telling the Soldier that clothing is stuck to the wound or that a chemical environment exists. For step 6, tell the Soldier that the casualty's condition is becoming worse, and have him/her show you (on a mannequin) or tell you what he/she would do to decompress the chest. Do not evaluate step 8 in the simulated mode.

Performance Measures	GO	NO GO
1. Uncovered the wound unless clothing was stuck to the wound or a chemical environment existed.	_____	_____

Performance Measures	GO	NO GO
2. Applied airtight material over the wound without touching the inner surface of the airtight material.	_____	_____
a. Fully opened the outer wrapper of the casualty's dressing or other airtight material.		
b. Applied the inner surface of the outer wrapper or other airtight material directly over the wound after the casualty exhaled completely.		
c. Held the material in place.		
3. Applied the casualty's dressing.	_____	_____
a. Applied the dressing/pad, white side down, directly over the airtight material.		
b. Had the casualty breathe normally.		
c. Maintained pressure on the dressing while wrapping the tails (or elastic bandage) around the body and back to the starting point.		
d. For a field dressing, tied the tails into a nonslip knot over the center of the dressing after the casualty exhaled completely. For an emergency trauma dressing, passed the tail through the plastic pressure device, reversed the tail while applying pressure, continued to wrap the tail around the body, and secured the plastic fastening clip to the last turn of the wrap.		
e. Ensured that the dressing was secured without interfering with breathing.		
4. When practical, applied direct manual pressure over the dressing for 5 to 10 minutes to help control the bleeding.	_____	_____
5. Positioned the casualty on the injured side or in a sitting position, whichever made breathing easier.	_____	_____
6. Performed needle chest decompression, if necessary.	_____	_____
a. Located the correct insertion site.		
b. Inserted the needle until the chest cavity was penetrated.		
c. Withdrew the needle while holding the catheter in place, and secured the catheter to the chest wall with tape.		
7. Performed steps 1 through 6 in the correct sequence.	_____	_____



Performance Measures	GO	NO GO
8. Watched the casualty closely for life-threatening conditions, checked for other injuries (if necessary), and treated for shock. Sought medical aid.	_____	_____

**Evaluation Guidance:** Refer to chapter 1, paragraph 1-9e, (1) and (2).

**References**

**Required:**

**Related:** FM 4-25.11

## 081-831-1032

### Perform First Aid for a Bleeding and/or Severed Extremity

**Conditions:** You have a casualty who has a bleeding wound of the arm or leg. The casualty is breathing. You will need the casualty's emergency trauma dressing or field dressing, materials to improvise a pressure dressing (wadding and cravat or strip of cloth), materials to elevate the extremity (blanket, shelter half, poncho, log, or any available material), and combat application tourniquet (C-A-T) or materials to improvise a tourniquet—rigid object (stick, tent peg, or similar object) and a strip of cloth.

**Standards:** Control bleeding from the wound following the correct sequence. Place a dressing over the wound with the sides of the dressing sealed so it does not slip. Ensure that the dressings do not have a tourniquet-like effect. Apply a tourniquet to stop profuse bleeding not stopped by the dressings, for severed arms and legs, or to control life-threatening bleeding when under fire.

#### Performance Steps

**Note:** If the wound is a partial or complete amputation of the arm or leg, you will need to apply a tourniquet on the injured extremity. Also, if you are under fire and need to control bleeding quickly, apply a tourniquet first. When the tactical situation allows, you can loosen the tourniquet after applying other measures to control the bleeding such as a pressure dressing. Go to step 5.

1. Uncover the wound unless clothing is stuck to the wound or you are in a chemical environment.

**CAUTION**

Clothing or anything stuck to the wound should be left alone to avoid injury. Do NOT attempt to clean the wound.

**CAUTION**

Do NOT remove protective clothing in a chemical environment. Apply dressings over the protective clothing.

2. Apply the casualty's dressing.
  - a. Emergency trauma dressing.

**Note:** The emergency trauma dressing is a new item that can be used on any bleeding wound. It can be used both as a field dressing and as a pressure dressing.

- (1) Place the pad on the wound, white side down, and wrap the elastic bandage around the limb.
- (2) Insert the elastic bandage into the pressure bar.

## Performance Steps

- (3) Tighten the elastic bandage.
- (4) Pull back, forcing the pressure bar down onto the pad.
- (5) Wrap the elastic bandage tightly over the pressure bar and wrap it over all edges of the pad.
- (6) Secure the hooking ends of the closure bar into the elastic bandage.

### WARNING

Emergency trauma dressings, field dressings, and pressure dressings should NOT have a tourniquet-like effect. The dressing must be loosened if the skin beyond the injury becomes cool, blue, or numb.

- b. Field dressing.
    - (1) Apply the dressing, white side down, directly over the wound.
    - (2) Wrap each tail, one at a time, in opposite directions around the wound so the dressing is covered and both sides are sealed.
    - (3) Tie the tails into a nonslip knot over the outer edge of the dressing—NOT over the wound.
    - (4) Check the dressing to make sure that it is tied firmly enough to prevent slipping without causing a tourniquet-like effect.
  3. Apply manual pressure and elevate the arm or leg to reduce bleeding, if necessary.
    - a. Apply firm manual pressure over the dressing for 5 to 10 minutes, when practical.
    - b. Elevate the injured part above the level of the heart unless a fracture is suspected and has not been splinted.
  4. If a field dressing was applied and bleeding continues, apply a pressure dressing.
    - a. Keep the arm or leg elevated.
    - b. Place a wad of padding directly over the wound.
    - c. Place an improvised dressing over the wad of padding and wrap it tightly around the limb.
    - d. Tie the ends in a nonslip knot directly over the wound.
    - e. Check the dressing to make sure that it does not have a tourniquet-like effect.
-

## Performance Steps

**Note:** If the bleeding stops, watch the casualty closely, and check for other injuries.

**Note:** If the bleeding continues despite proper application of a field dressing and a pressure dressing or an emergency trauma dressing, or if the wound is a partial or complete amputation of the arm or leg, apply a tourniquet on the injured extremity. If only part of a hand or foot has been severed, the bleeding should be stopped using a pressure dressing.

### 5. Apply a tourniquet.

#### a. Combat application tourniquet (C-A-T).

(1) Remove the C-A-T from the pouch.

(2) Slide the wounded extremity through the loop of the self-adhering band.

**Note:** The C-A-T is packaged in its one-handed configuration.

(3) Position the C-A-T.

(a) If the wound is **above** the knee or elbow, position the C-A-T 2 inches above a bleeding site.

#### CAUTION

Never place a tourniquet directly over a wound, fracture, or joint.

(b) If the wound is **below** the knee or elbow, initially position the tourniquet band 2 inches above the wound. If a tourniquet applied below the knee or elbow is not successful at stopping the bleeding, apply a second tourniquet 2 inches above the joint (knee or elbow). Do not remove the first tourniquet until the second tourniquet has been applied.

(4) Pull the free running end of the self-adhering band tight and securely fasten it back on itself. Do NOT adhere the band past the windlass clip.

**Note:** The friction adaptor buckle is not necessary for proper C-A-T application to an arm. However, use it as added protection when using two hands to apply the C-A-T to a leg. To use it, route the self-adhering band through the friction adaptor buckle. This also prevents the strap from loosening during transport.

(5) Twist the windlass rod until the bleeding has stopped.

(6) Lock the windlass rod in place with the windlass clip.

**Note:** For added security (and always before moving a casualty), secure the windlass rod with the windlass strap. For small extremities, also secure the self-adhering band under the windlass strap.

(7) For small extremities, wind the self-adhering band around the extremity and over the windlass rod.

(8) Grasp the windlass strap, pull it tight, and adhere it to the opposite hook on the windlass clip.

#### b. Improvised tourniquet.

(1) Make a tourniquet at least 2 inches wide.

(2) Position the tourniquet.

(a) Place the tourniquet over the smoothed sleeve or trouser leg if possible.

## Performance Steps

(b) If the wound is **above** the knee or elbow, place the tourniquet around the limb 2 to 4 inches above the wound between the wound and the heart but not on a joint or directly over a wound or a fracture.

(c) If the wound is **below** the knee or elbow, initially position the tourniquet band 2 inches above the wound. If a tourniquet applied below the knee or elbow is not successful at stopping the bleeding, apply a second tourniquet 2 to 4 inches above the joint (knee or elbow). Do not remove the first tourniquet until the second tourniquet has been applied.

(3) Put on the tourniquet.

(a) Tie a half knot.

(b) Place a stick (or similar object) on top of the half knot.

(c) Tie a full knot over the stick.

(d) Twist the stick until the tourniquet is tight around the limb and bright red bleeding has stopped.

**Note:** In the case of an amputation, dark oozing blood may continue for a short time.

(4) Secure the tourniquet. The tourniquet can be secured using the ends of the tourniquet band or with another piece of cloth, as long as the stick does not unwind.

**Note:** If a limb is completely amputated, the stump should be padded and bandaged (do not cover the tourniquet).

**Note:** If a tourniquet was applied to quickly control bleeding under fire, once the tactical situation allows, you can loosen the tourniquet after other measures have been applied to control the bleeding if it has been in place for less than 6 hours. However, do NOT remove it. Use direct pressure or a pressure dressing to control the bleeding prior to loosening the tourniquet. If unable to control bleeding by these methods, retighten the tourniquet until the bleeding stops.

6. If a tourniquet was applied, mark the casualty's forehead with a letter T and the time—using a pen, mud, the casualty's blood, or whatever is available.

7. If applicable and the situation allows, save severed limbs or body parts and transport them with, but out of sight of, the casualty.

**Note:** Body parts should be wrapped in dry, sterile dressing and placed in a dry, plastic bag and, in turn, placed in a cool container (do not soak in water or saline or allow to freeze). If your location in the field/combat does not allow for the correct preserving of parts; do what you can.

8. Watch the casualty closely for life-threatening conditions, check for other injuries (if necessary), and treat for shock. Seek medical aid.

---

**Evaluation Preparation:** *Setup:* Use the same dressing repeatedly. If a field dressing is being used, have materials available for a pressure dressing (wadding and cravat or a strip of cloth). Have one Soldier play the part of the casualty and another apply the dressing(s). Use a moulage or mark a place on the casualty's arm or leg to simulate a wound. For applying a tourniquet, use a mannequin or simulated arm or leg (padded length of 2-inch by 4-inch wood with a glove or boot on one end) with a

dressing appropriately placed on the arm or leg. Under no circumstances will a live simulated casualty be used to evaluate the application of a tourniquet. Place the tourniquet materials nearby.

*Brief Soldier:* Tell the Soldier to do, in order, the first aid steps required to apply a dressing and, if necessary, a pressure dressing on the casualty's wound. When testing step 1, you can vary the test by telling the Soldier that clothing is stuck to the wound or that a chemical environment exists. After steps 2 and 3, tell the Soldier that the bleeding has not stopped. After step 4, tell the Soldier the bleeding is continuing and ask the Soldier to describe and perform the first aid on the simulated arm or leg provided. After step 5, ask the Soldier what should be done to indicate that a tourniquet has been applied and what should be done with a severed limb, if applicable. Do not evaluate step 9 in the simulated mode.

Performance Measures	GO	NO GO
1. Uncovered the wound, unless clothing was stuck to the wound or in a chemical environment.	_____	_____
2. Applied the casualty's dressing.	_____	_____
a. Applied the dressing/pad directly over the wound.		
b. Covered the edges of dressing/pad.		
c. Properly secured the bandage.		
d. Did not create a tourniquet-like effect with the dressing.		
3. Applied manual pressure and elevated the arm or leg, if necessary.	_____	_____
4. If a field dressing was applied and bleeding continued, applied a pressure dressing.	_____	_____
a. Placed the wad of padding directly over the wound.		
b. Tightly wrapped the cloth around the limb.		
c. Tied a nonslip knot directly over the wound.		
d. Did not create a tourniquet-like effect with the dressing.		
5. Applied a tourniquet, if necessary.	_____	_____
a. Improvised tourniquet, if used, was at least 2 inches wide.		
b. Tourniquet was placed at least 2 inches above the wound between the wound and the heart but not on a joint or directly over a wound or a fracture.		
c. Tourniquet was properly applied and secured.		
6. Performed steps 1 through 5, as necessary, in sequence.	_____	_____

Performance Measures	GO	NO GO
7. If a tourniquet was applied, marked the casualty's forehead with a letter T and the time.	_____	_____
8. If applicable and the situation allowed, saved severed limbs or body parts and transported them with the casualty.	_____	_____
9. Watched the casualty closely for life-threatening conditions, checked for other injuries (if necessary), and treated for shock. Sought medical aid.	_____	_____

**Evaluation Guidance:** Refer to chapter 1, paragraph 1-9e, (1) and (2).

**References**

**Required:**

**Related:** FM 4-25.11

## 081-831-1033

### Perform First Aid for an Open Head Wound

**Conditions:** You see a casualty who has an open head wound. The casualty is breathing. You will need the casualty's emergency trauma dressing or field dressing and a canteen of water.

**Standards:** Apply a dressing to the wound following the correct sequence, without causing further injury to the casualty. Properly position the casualty and secure the dressing without applying unnecessary pressure.

#### Performance Steps

1. Check the casualty's level of consciousness.
  - a. Question the casualty.
    - (1) "What is your name?"
    - (2) "Where are you?"
    - (3) "What is today's date (day, month, and year)?"
  - b. Report incorrect answers, inability to answer, or changes in answers to medical personnel.
2. Position the casualty.

#### WARNING

Do NOT move the casualty if the casualty exhibits signs and/or symptoms—other than minor bleeding—of a neck, spine, or severe head injury.

- a. The casualty is conscious or has a minor scalp wound.
  - (1) Have the casualty sit up unless other injuries prohibit sitting up.
  - (2) Raise the head slightly if the casualty is lying down and is not accumulating fluids in his/her throat.
  - (3) Turn his/her head to the side or position the casualty on his/her side (opposite the wound) if the wound is bleeding into the mouth or throat.

## Performance Steps

b. The casualty is unconscious or has a severe head injury.

(1) Treat the casualty as having a potential neck or spinal injury. Immobilize and do not move the casualty unless absolutely necessary.

(2) Turn the casualty if he/she is choking and/or vomiting or bleeding into the mouth. Position the casualty on his/her side opposite the wound.

### WARNING

If it is necessary to turn a casualty with a suspected neck or spinal injury, you will need assistance. Keeping the head, neck, and body aligned while providing support for the head and neck, roll the casualty gently onto his/her side.

3. Expose the wound by removing the casualty's helmet, if necessary.

### WARNING

In a chemical, biological, radiological, and nuclear (CBRN) environment, you must leave the casualty with as much protection (such as protective mask, mission-oriented protective posture [MOPP] overgarments) as possible. What items of protective equipment can be removed depends on the casualty's injuries (where on the body and what type), the MOPP level, integrity of protective equipment (such as tears in the garment or mask seal), availability of chemical protective shelters, and the tactical situation.

4. Apply the casualty's dressing to the wound.

### WARNING

Do NOT attempt to clean the wound or remove a protruding object.

Do NOT put unnecessary pressure on the wound or attempt to push any brain matter back into the head (skull).

Do NOT apply a pressure dressing.

Do NOT give the casualty any food or drink.

*Note:* The following procedures are for applying a field dressing. If you are applying an emergency trauma dressing, follow the general procedure for other bleeding wounds, while observing general guidelines and precautions.

a. Forehead or back of the head.

(1) Apply the dressing, white side down, directly over the wound with the tails extending toward the sides of the head.

(2) Wrap the tails, one at a time, around the head in opposite directions, making sure the tails cover the dressing but not the eyes and ears.

(3) Tie the tails at the side of the head using a nonslip knot.

b. Top of the head.

(1) Apply the dressing, white side down, directly over the wound.

(2) Wrap one tail down under the chin and bring it up in front of the ear over the dressing to a point just above, and in front of, the opposite ear.

## Performance Steps

### WARNING

Ensure the tails remain wide and close to the front of the chin to avoid choking the casualty.

(3) Wrap the other tail down under the chin in the opposite direction and up the side of the head to meet the first tail.

(4) Cross the tails.

(5) Wrap one tail across the forehead above the eyebrows to a point just above and in front of the opposite ear.

(6) Wrap the other tail above the ear, low over the back of the head, and above the opposite ear to meet the other tail.

(7) Tie the tails using a nonslip knot.

c. Side of the head or cheek.

(1) Apply the dressing, white side down, directly over the wound with the tails extending up and down.

(2) Wrap the top tail over the top of the head, down in front of the ear, under the chin, and up over the dressing to a point just above the ear.

(3) Wrap the other tail in the opposite direction to meet the first tail.

(4) Cross the tails and complete the procedure as follows:

(a) Wrap one tail across the forehead above the eyebrows to a point just above, and in front of, the opposite ear.

(b) Wrap the other tail above the ear, low over the back of the head, and above the opposite ear to meet the other tail.

(c) Tie the tails using a nonslip knot.

5. Watch the casualty for life-threatening conditions, check for other injuries (if necessary), and treat for shock. Seek medical aid.

**Evaluation Preparation:** *Setup:* Use the same dressing repeatedly. Have another Soldier act as the casualty. Use a moulage or otherwise simulate a wound to the forehead, back of the head, side of the head, cheek, or top of the head. Brief the casualty on how to answer the Soldier's questions during step 1. You can have a canteen of water available and have the casualty say that he/she is thirsty to see if the Soldier knows what to do.

*Brief Soldier:* Tell the Soldier to do, in order, all necessary first aid steps to treat the casualty's wound. Tell the Soldier that it is not in a chemical environment. Do not evaluate step 6 in the simulated mode.

Performance Measures	GO	NO GO
1. Checked the casualty's level of consciousness.	_____	_____
2. Positioned the casualty correctly for the location of the wound.	_____	_____
3. Exposed the wound.	_____	_____
4. Applied the casualty's dressing.	_____	_____



Performance Measures	GO	NO GO
a. Applied the dressing/pad directly over the wound.		
b. Covered the edges of the dressing/pad.		
c. Properly secured the bandage.		
d. Did not cover the eyes or ears or choke the casualty with the bandage.		
5. Performed steps 1 through 4 in the correct sequence.	_____	_____
6. Watched the casualty closely for life-threatening conditions, checked for other injuries (if necessary), and treated for shock. Sought medical aid.	_____	_____

**Evaluation Guidance:** Refer to chapter 1, paragraph 1-9e, (1) and (2).

### References

#### Required:

**Related:** FM 4-25.11

## 081-831-1034

### Perform First Aid for a Suspected Fracture

**Conditions:** You see a casualty who has an arm or leg that you think is broken. The casualty has no more serious wounds or conditions that have not been treated. You will need splint materials (boards, poles, tree branches), padding materials (clothing, blanket, dressing, leafy vegetation), and tie materials (strips of cloth, belts).

**Standards:** Splint the suspected broken arm or leg so that the arm or leg does not move and circulation is not impaired.

#### Performance Steps

1. Prepare the casualty for splinting.
  - a. Reassure the casualty if he/she is conscious and able to understand. Tell the casualty that you will be taking care of him/her.
  - b. Loosen any tight or binding clothing.

#### WARNING

Do NOT remove any protective clothing or boots in a chemical environment. Apply the splint over the clothing.

#### WARNING

Do NOT remove boots from the casualty unless they are needed to stabilize a neck injury or there is actual bleeding from the foot.

- c. Remove all jewelry from the affected limb and place it in the casualty's pocket. Tell the casualty that you are doing this to prevent further injury if swelling occurs later.

## Performance Steps

### 2. Get splinting materials.

- a. Get splints (wooden boards, tree branches, poles, an unloaded rifle) long enough to reach beyond the joints above and below the broken part.
- b. Get materials to pad the splints, such as a jacket, blanket, poncho, shelter half, or leafy vegetation.
- c. Get tie materials, such as strips of cloth or belts, to tie the splints.

*Note:* If splinting materials are not available, use the chest wall to immobilize a suspected fracture of the arm and the uninjured leg to immobilize the fractured leg. Continue with steps 7 and 8.

### 3. Pad the splints. Apply padding between the splint and the bony areas of the body. Suggested sites for padding: wrist, elbow, ankle, knee, crotch, and armpit.

*Note:* You may have access to a universal or “SAM” splint. This splint is coated with a synthetic padding and does not require additional padding.

### 4. Check for signs of blood circulation problems below the injury.

- a. Check light-skinned persons for color of skin (skin may be pale, white, or a bluish-gray color).
- b. Check dark-skinned persons by depressing the toenail or fingernail beds and seeing how fast the color returns. A slower return of color to the injured side indicates a circulation problem.
- c. Feel the injured arm or leg to see if it is colder than the uninjured one.
- d. Ask the casualty about the presence of numbness, tightness, or a cold sensation.

#### WARNING

If there is a blood circulation problem, evacuate the casualty as soon as possible.

### 5. Put on a splint.

#### WARNING

If the fracture is open, do NOT attempt to push bones back under the skin. Apply a dressing to protect the area.

- a. As a rule, splint the fracture in the position found.

#### CAUTION

Do NOT try to reposition or straighten the fracture unless there is no circulation below the fracture site or you cannot effectively splint it. Realignment the limb may restore circulation.

## Performance Steps

- (1) If there is no circulation below the fracture site, or if the limb is grossly angulated and you cannot effectively splint it, you may need to gently realign the limb to effectively splint the fracture site.
- (2) With one hand supporting the fracture site, use the other hand to grasp the part of the limb farthest from the fracture and gently place traction on it (pull in the direction of the long axis of the bone, like extending a telescope).
  - b. Place one splint on each side of the arm or leg. Make sure the splints reach beyond the joints above and below the fracture.
  - c. Tie the splints with improvised (or actual) cravats.
    - (1) Gently place at least two cravats above and two cravats below the fracture if possible.

### WARNING

Do NOT tie any cravats directly over the fracture.

- (2) Tie nonslip knots on the splint away from the injury.
6. Check the splint for tightness.
    - a. Make sure the cravats are tight enough to hold the splinting materials securely in place.
    - b. Recheck circulation below the injury to make sure that circulation is not impaired.
    - c. Make any adjustments without allowing the splint to become ineffective.
  7. Apply an arm sling if applicable.

*Note:* An arm sling can be used to further immobilize an arm and to provide support by the uninjured side.

    - a. Make a sling from any nonstretching material (such as a strip of clothing or blanket, poncho, shelter half, belt, or shirttail).
    - b. Apply the sling so the supporting pressure is on the casualty's uninjured side.
    - c. Make sure the hand of the supported arm is slightly higher than the elbow.
  8. Apply swathes if applicable.

*Note:* Apply swathes when the casualty has a splinted, suspected fracture of the elbow or leg, or when a suspected fracture cannot be splinted. (Improvise swathes from large pieces of cloth or belts.)

### WARNING

Place swathes above and/or below the fracture, not over it.

## Performance Steps

- a. Apply swathes to an injured arm by wrapping the swathes over the injured arm, around the casualty's back, and under the arm on the uninjured side. Tie the ends on the uninjured side.
  - b. Apply swathes to an injured leg by wrapping the swathes around both legs and tying the swathes on the uninjured side.
9. Watch the casualty closely for life-threatening conditions, and check for other injuries. Seek medical aid.

**Evaluation Preparation:** *Setup:* You will need another Soldier to play the part of the casualty. Have the casualty lie down or sit. Place splinting materials nearby. Have available splints, padding, and materials for ties, slings, and swathes that are appropriate to the fracture location on the arm or leg. If available, have two or more pairs of splints of varying lengths to help in scoring step 1.

*Brief Soldier:* Tell the Soldier that the casualty has a suspected closed fracture and where it is located (lower arm, elbow, upper leg, or lower leg). Tell the Soldier to splint the suspected fracture. Do not evaluate step 8 in the simulated mode.

Performance Measures	GO	NO GO
1. Used splints that reached beyond the joints above and below the fracture.	_____	_____
2. Checked blood circulation below the fracture, both before and after applying the splints.	_____	_____
3. Applied padding between the splints and all bony areas.	_____	_____
4. Used at least four ties (two above and two below the fracture) to secure the splints, if possible.	_____	_____
5. Tied nonslip knots on the splint away from the injury.	_____	_____
6. Immobilized the splinted arm or leg using a sling and/or swathes, as required, to prevent easy movement.	_____	_____
7. Checked the splint for tightness.	_____	_____
8. Watched the casualty for life-threatening conditions and checked for other injuries. Sought medical aid.	_____	_____

**Evaluation Guidance:** Refer to chapter 1, paragraph 1-9e, (1) and (2).

## References

### Required:

**Related:** FM 4-25.11

---

## 081-831-1044

### Perform First Aid for Nerve Agent Injury

**Conditions:** You and your unit are in an area where there is a threat of chemical attack. You are wearing protective overgarments and/or mask, or they are immediately available. There are casualties with possible nerve agent injuries. You will need chemical protective gloves, overgarments, overboots, protective mask and hood, mask carrier, and nerve agent antidote autoinjectors. The casualty has three sets of MARK I nerve agent antidote autoinjectors or three antidote treatment nerve agent autoinjector (ATNAAs) and one convulsant antidote for nerve agents (CANA) autoinjector.

**Standards:** Administer the antidote correctly to yourself, or administer three sets of MARK I nerve agent antidote autoinjectors or three ATNAAs followed by the CANA to a buddy following the correct sequence.

#### Performance Steps

**Note:** The ATNAA system is a nerve agent antidote device that will be used by the Armed Forces. A single ATNAA delivers both the atropine and pralidoxime chloride (2 PAM Cl). The ATNAA is replacing the MARK I as supplies of the MARK I are exhausted.

**Note:** When performing first aid on a casualty, seek medical aid as soon as possible. Do NOT stop the first aid. If the situation allows, send another person to find medical aid.

1. Identify mild signs and symptoms of nerve agent poisoning.
  - a. Unexplained runny nose.
  - b. Unexplained sudden headache.
  - c. Sudden drooling.
  - d. Tightness in the chest or difficulty breathing.
  - e. Difficulty seeing (dimness of vision or miosis).
  - f. Localized sweating and muscular twitching in the area of contaminated skin.
  - g. Stomach cramps.
  - h. Nausea.

**Note:** For the above signs and symptoms, first aid is considered to be self-aid.

2. React to the chemical hazard.
  - a. Put on your protective mask.

**Note:** Do NOT put on additional protective clothing at this time. Give yourself the nerve agent antidote first. Then, decontaminate exposed skin areas and put on remaining protective clothing.

- b. Give the alarm.
3. Administer nerve agent antidote to self (self-aid), if necessary.

## Performance Steps

### a. MARK I.

(1) Prepare to administer one atropine injection.

(a) Remove one set of MARK I from your protective mask carrier, from the pocket of the MOPP suit, or from another location as specified by your unit standing operating procedure (SOP).

(b) With one hand, hold the set of injectors by the plastic clip at eye level with the big injector on top.

(c) With the other hand, check the injection site to avoid buttons and objects in pockets where injecting.

(d) Grasp the small injector without covering or holding the needle (green) end, and pull it out of the clip with a smooth motion.

(e) Form a fist around the autoinjector with the needle (green) end extending beyond the little finger end of the fist. Be careful not to inject yourself in the hand.

**Note:** If the injection is accidentally given in the hand, another small injector must be obtained and the injection given in the proper site.

(f) Place the needle end of the injector against the outer thigh muscle or buttock. For injections into the thigh, grasp the trouser cargo pocket and pull forward, clearing possible obstructions from the site.

**Note:** The injection can be given in any part of the lateral thigh muscle from about a hand's width above the knee to a hand's width below the hip joint.

**Note:** Very thin Soldiers should give the injection in the upper, outer part of the buttock.

### CAUTION

When injecting antidote in the buttock, be very careful to inject only into the upper, outer quarter of the buttock to avoid hitting the major nerve that crosses the buttocks. Hitting the nerve may cause paralysis.

(2) Administer the atropine injection.

(a) Push the injector into the muscle with firm, even pressure until it functions.

**Note:** A jabbing motion is not necessary to trigger the activating mechanism.

(b) Hold the injector firmly in place for at least 10 seconds.

(c) Remove the injector from your muscle and carefully place this used injector between two fingers of the hand holding the plastic clip.

(3) Prepare to administer one 2 PAM Cl injection.

(a) Pull the large injector out of the clip and form a fist around the autoinjector with the needle (black) end extending beyond the little finger. Drop the clip to the ground.

(b) Place the needle end of the injector against the injection site.

(4) Administer the 2 PAM Cl injection.

(a) Push the injector into the muscle with firm, even pressure until it functions.

## Performance Steps

- (b) Hold the injector firmly in place for at least 10 seconds.
- (5) Secure the used injectors.
  - (a) Use a hard surface to bend each needle to form a hook.
  - (b) Push the needle of each injector (one at a time) through one of the pocket flaps of the protective overgarment. Be careful not to tear your protective clothing or gloves with the needles.
  - (6) Massage the injection site, mission permitting.
- b. ATNAA.
  - (1) Prepare to administer one ATNAA.
    - (a) Remove one ATNAA from your protective mask carrier, from the pocket of the MOPP suit, or from another location as specified by your unit SOP.
    - (b) Remove the autoinjector from the pouch.
    - (c) With your dominant hand, hold the ATNAA in your closed fist with the needle (green) end extending beyond the little finger in front of you at eye level.
    - (d) With your nondominant hand, grasp the safety (gray) cap with the thumb and first two fingers.

### CAUTION

Do NOT cover or hold the needle end with your hand, thumb, or fingers. You may accidentally inject yourself.

- (e) Pull off the safety cap from the bottom of the injector with a smooth motion and drop it to the ground.
- (f) With the nondominant hand, check the injection site to avoid buttons and objects in the pockets. For injections into the thigh, grasp the trouser cargo pocket and pull forward, clearing possible obstructions from the site.
- (g) Place the needle end of the injector against the outer thigh muscle or buttock.

*Note:* The injection can be given in any part of the lateral thigh muscle from about a hand's width above the knee to a hand's width below the hip joint.

*Note:* Very thin Soldiers should give the injection in the upper, outer part of the buttock.

### CAUTION

When injecting antidote in the buttock, be very careful to inject only into the upper, outer quarter of the buttock to avoid hitting the major nerve that crosses the buttocks. Hitting the nerve may cause paralysis.

- (2) Administer the ATNAA injection.
  - (a) Push the injector into the muscle with firm, even pressure until it functions.

*Note:* A jabbing motion is NOT necessary to trigger the activating mechanism.

- (b) Hold the injector firmly in place for at least 10 seconds.

## Performance Steps

(c) Remove the injector from your muscle.

(3) Secure the used injector.

(a) Use a hard surface to bend the needle to form a hook, without tearing protective gloves or clothing.

(b) Push the needle of the used injector through one of the pocket flaps of the protective overgarment.

(4) Massage the injection site, mission permitting.

**Note:** Seek overhead cover or use a poncho to provide cover, mission permitting.

4. Decontaminate skin if necessary.

**Note:** Information on this step is provided in task 031-503-1013.

5. Put on remaining protective clothing.

**Note:** Information on this step is covered in task 031-503-1015.

6. Seek buddy aid or medical aid.

### WARNING

Do NOT give yourself additional injections. If you are able to walk without assistance and know who you are and where you are, you will NOT need the second set of injections. If you continue to have symptoms of nerve agent poisoning, seek someone else (a buddy) to check your symptoms and administer the additional sets of injections, if required.

7. Identify severe signs and symptoms of nerve agent poisoning.

- a. Strange or confused behavior.
- b. Wheezing, difficulty in breathing (dyspnea), and coughing.
- c. Severely pinpointed pupils.
- d. Red eyes with tearing.
- e. Vomiting.
- f. Severe muscular twitching and general weakness.
- g. Involuntary urination and defecation.
- h. Convulsions.
- i. Unconsciousness or stoppage of breathing.

**Note:** If the casualty is exhibiting severe symptoms, he/she will require assistance (buddy aid) to complete the first aid treatment.

8. Mask the casualty if necessary.



**WARNING**

Do NOT kneel at any time while providing aid to the casualty. Contact with the ground could force the chemical into or through the protective clothing.

*Note:* Reposition the casualty on his/her back, if necessary, to mask the individual.

- a. Place the mask on the casualty.
  - b. If the casualty can follow directions, have him/her clear the mask.
  - c. Check for a complete mask seal by covering the inlet valves of the mask.
  - d. Pull the protective hood over the head, neck, and shoulders of the casualty.
  - e. Position the casualty on the right side, similar to a swimmer's position, with the head slanted down so that the casualty will not roll back over.
9. Administer first aid to a nerve agent casualty (buddy aid).
- a. MARK I.
    - (1) Prepare to administer one atropine injection.
      - (a) Position yourself near the casualty's thigh.
      - (b) Remove all three sets of autoinjectors and the single CANA autoinjector from the casualty's mask carrier, battle dress uniform (BDU) pocket, or from another location as specified by your unit SOP. Place the injectors and CANA on the casualty's side. Do NOT place the unused devices on the ground.
      - (c) With one hand, hold one MARK I set by the plastic clip at eye level with the big injector on top.
      - (d) With the other hand, check the injection site to avoid buttons and objects in his/her pockets. For injections into the thigh, grasp the trouser cargo pocket and pull forward (toward you), clearing possible obstructions from the site.
      - (e) Grasp the small injector and pull it out of the clip with a smooth motion.
      - (f) Hold the injector in your closed fist with the needle (green) end pointing out by your little finger without covering the needle end.
      - (g) Place the needle end of the injector against the casualty's lateral thigh muscle or buttock.
-

## Performance Steps

**Note:** The injection can be given in any part of the lateral thigh muscle from about a hand's width above the knee to a hand's width below the hip joint.

**Note:** Very thin Soldiers should be given the injections in the upper, outer part of the buttock.

### WARNING

When injecting antidote in the buttock, be very careful to inject only into the upper, outer quarter of the buttock to avoid hitting the major nerve that crosses the buttocks. Hitting the nerve may cause paralysis.

(2) Administer the atropine injection.

(a) Push the injector into the muscle with firm, even pressure until it functions.

(b) Hold the injector in place for at least 10 seconds.

(c) Remove the injector from the muscle and carefully place the used injector between two fingers of the hand holding the clip.

(3) Prepare to administer one 2 PAM Cl injection.

(a) Pull the large injector out of the clip and hold the injector in your closed fist with the needle (black) end pointing out by your little finger, without covering the needle end. Drop the clip to the ground.

(b) Place the needle end of the injector against the injection site.

(4) Administer the 2 PAM Cl injection.

(a) Push the injector into the muscle with firm, even pressure until it functions.

(b) Hold the injector in place for at least 10 seconds.

(c) Lay the used injectors on the casualty's side.

**Note:** Repeat steps 10a(1) through 10a(4) until the casualty has received a total (including self-administered) of three sets of antidote injections.

b. ATNAA.

(1) Prepare to administer one ATNAA.

(a) Obtain three or all remaining ATNAAs and one CANA from the casualty's protective mask carrier, from the pocket of the MOPP suit, or from another location as specified by your unit SOP.

(b) Remove one ATNAA from its pouch.

(c) With your dominant hand, hold the ATNAA in your closed fist with the needle (green) end pointing out by your little finger, in front of you at eye level.

(d) With your nondominant hand, grasp the safety (gray) cap with the thumb and first two fingers.

### CAUTION

Do NOT cover or hold the needle end with your hand, thumb, or fingers. You may accidentally inject yourself.

## Performance Steps

(e) Pull the safety cap off the bottom of the injector with a smooth motion and drop it to the ground.

(f) With the nondominant hand, check the injection site to avoid buttons and objects in the pockets. For injections into the thigh, grasp the trouser cargo pocket and pull forward, clearing possible obstructions from the site.

(g) Place the needle end of the injector against the outer thigh muscle or buttock.

*Note:* The injection may be given in any part of the lateral thigh muscle from about a hand's width above the knee to a hand's width below the hip joint.

*Note:* Very thin Soldiers should be given the injection in the upper, outer part of the buttock.

### CAUTION

When injecting antidote in the buttock, be very careful to inject only into the upper, outer quarter of the buttock to avoid hitting the major nerve that crosses the buttocks. Hitting the nerve may cause paralysis.

(2) Administer the injection.

(a) Push the injector into the muscle with firm, even pressure until it functions.

*Note:* A jabbing motion is NOT necessary to trigger the activating mechanism.

(b) Hold the injector firmly in place for at least 10 seconds.

(c) Remove the injector from the muscle.

(d) Place the used injector on the casualty's side.

(3) Repeat the procedure for a total of three ATNAAs.

10. Administer the anticonvulsant, CANA.

a. Prepare to administer the CANA injection.

(1) Tear the protective plastic packet open and remove the injector.

(2) With your dominant hand, hold the injector in your closed fist with the needle (black) end pointing out by your little finger.

(3) With the other hand, pull the safety cap off the injector base to arm the injector.

### CAUTION

Do NOT touch the needle end. You could accidentally inject yourself.

(4) Place the needle end of the injector against the casualty's injection site.

b. Administer the CANA injection.

(1) Push the injector into the muscle with firm, even pressure until it functions.

(2) Hold the injector in place for at least 10 seconds.

11. Secure the casualty's used injectors.

## Performance Steps

- a. Use a hard surface to bend each needle to form a hook, without tearing protective gloves or clothing.
  - b. Push the needle of each used injector (one at a time) through one of the pocket flaps of the casualty's protective overgarment.
12. Decontaminate the casualty's skin, if necessary.

**Note:** This information is covered in task 031-503-1013.

13. Seek medical aid.

**Evaluation Preparation:** *Setup:* You must use nerve agent antidote injection training aids to train and evaluate this task. Actual autoinjectors will not be used. For self-aid, have the Soldier dress in MOPP 2. Have the Soldier wear a mask carrier containing a mask and the training nerve agent autoinjectors. For buddy aid, have the Soldier being tested and the casualty dress in MOPP 2. Have the casualty lie on the ground wearing the mask carrier containing a mask and the training nerve agent autoinjectors.

*Brief Soldier:* For step 1, tell the Soldier to state, in any order, the mild symptoms of nerve agent poisoning. The Soldier must state seven of the eight symptoms to be scored GO. Tell the Soldier that he/she has mild symptoms and must take appropriate action. After the Soldier completes step 3, ask what should be done next. Then ask what he/she should do after putting on all protective clothing. Score steps 4 through 6 based on the Soldier's responses. For step 7, tell the Soldier to state, in any order, the severe symptoms of nerve agent poisoning. The Soldier must state eight of the nine symptoms to be scored GO. Tell the Soldier to treat the casualty for nerve agent poisoning. After the Soldier completes step 11, ask what else he/she should do. Score steps 12 and 13 based on the Soldier's responses.

Performance Measures	GO	NO GO
1. Identified mild signs of nerve agent poisoning.	_____	_____
2. Reacted to the chemical hazard.	_____	_____
3. Correctly administered the nerve agent antidote to him or herself.	_____	_____
4. Decontaminated the skin, if necessary.	_____	_____
5. Put on remaining protective clothing.	_____	_____
6. Sought help (buddy aid).	_____	_____
7. Identified severe signs of nerve agent poisoning.	_____	_____
8. Masked the casualty.	_____	_____
9. Correctly administered nerve agent antidote to the casualty.	_____	_____
10. Correctly administered the CANA injection to the casualty.	_____	_____

Performance Measures	GO	NO GO
11. Secured the casualty's used injectors.	_____	_____
12. Decontaminated the casualty's skin, if necessary.	_____	_____
13. Sought medical aid.	_____	_____
14. Performed steps 1 through 12 in the correct sequence.	_____	_____

**Evaluation Guidance:** Refer to chapter 1, paragraph 1-9e, (1) and (2).

### References

### Required:

**Related:** DVC 08-36, DVC 08-37, and FM 4-25.11

## 081-831-1045

### Perform First Aid for Cold Injuries

**Conditions:** You see a casualty who has signs and symptoms of a cold injury. You will need a canteen of potable water, blanket (or similar item to use for warmth), and dry clothing.

**Standards:** Identify the type of cold injury and give the correct first aid.

#### Performance Steps

**Note:** When performing first aid on a casualty, seek medical aid as soon as possible. Do NOT stop the first aid; but, if the situation allows, send another person to find medical aid.

1. Identify the type of cold injury.
    - a. Chilblain. If the signs and symptoms are as follows, go to step 2a.
      - (1) Prolonged exposure of bare skin at temperatures of 60° F to 32° F or 20° F for acclimated, dry, unwashed skin.
      - (2) The area may be acutely swollen, red, tender, and hot with itchy skin.
      - (3) There may be no skin tissue loss in untreated cases but continued exposure may lead to infected, ulcerated, or bleeding lesions.
    - b. Frostbite. If the signs and symptoms are as follows, go to step 2b.
      - (1) Exposure to cold, usually below 32°F depending on the wind chill factor, duration of exposure, and adequacy of protection. Individuals with a history of cold injury are likely to suffer an additional cold injury.
- Note:** The body parts most easily frostbitten are the cheeks, nose, ears, chin, forehead, wrists, hands, and feet. Frostbite may involve only the skin (superficial), or it may extend to a depth below the skin (deep).
- (2) Loss of sensation or numb feeling in any part of the body.
  - (3) Sudden blanching (whitening) of the skin of the affected part, followed by a momentary tingling feeling.
  - (4) Redness of skin in light-skinned Soldiers, grayish coloring in dark-skinned Soldiers.
  - (5) Blisters.

## Performance Steps

- (6) Swelling or tender areas.
- (7) Loss of previous feeling of pain in the affected area.
- (8) Pale, yellowish, waxy-looking skin.
- (9) Frozen tissue that feels solid (or wooden) to the touch.

### CAUTION

Deep frostbite (when freezing extends to a depth below the skin) is a very serious injury and requires immediate first aid and subsequent medical treatment to avoid or minimize loss of body parts.

c. Immersion foot/trench foot. If the signs and symptoms are as follows, go to step 2c.

(1) Fairly long exposure of feet to wet conditions at temperatures from about 50° F to 32° F.

(2) First stage.

(a) Parts of the affected foot are cold and painless.

(b) Pulse is weak.

(c) Numbness may be present.

(3) Second stage.

(a) Parts may feel hot and burning.

(b) Shooting pains may begin.

(4) Later stages.

(a) Skin is pale with a bluish cast.

(b) Pulse decreases.

(c) Other signs that may follow include blisters, swelling, redness, heat, bleeding, or gangrene.

d. Snow blindness. If the signs and symptoms are as follows, go to step 2d.

(1) Sensation of grit in the eyes with pain in and over the eyes, made worse by moving the eyeball.

(2) Watery eyes.

(3) Redness.

(4) Headache.

(5) Increased pain with exposure to light.

e. Hypothermia. If the signs and symptoms are as follows, go to step 2e.

(1) Early.

(a) Shivering.

(b) Pulse is faint or very difficult to detect.

(c) Drowsiness and mental slowness.

(d) Stiffness and lack of coordination.

## Performance Steps

- (e) Slurred speech.
  - (2) Moderate.
    - (a) Glassy eyes.
    - (b) Slow and shallow breathing.
    - (c) Very weak or absent pulse.
    - (d) Increasing stiffness and lack of coordination.
    - (e) Unconsciousness.
  - (3) Severe.
    - (a) Frozen extremities.
    - (b) Irregular heart action.
    - (c) Sudden death.
  - f. Dehydration (cold weather). If the signs and symptoms are as follows, go to step 2f.
    - (1) Parched and dry mouth, tongue, and throat.
    - (2) Difficulty swallowing.
    - (3) Nausea (with or without vomiting).
    - (4) Extreme dizziness and fainting.
    - (5) Tired and weak feeling.
    - (6) Muscle cramps.
    - (7) Difficulty focusing eyes.
  - 2. Perform first aid for the cold injury.
    - a. Chilblain.
      - (1) Rewarm the affected part by applying firm steady pressure with your hands or placing the affected part under your arms or against the stomach of a buddy.
      - (2) Do NOT rub or massage affected areas.
      - (3) Have medical personnel evaluate the injury because signs and symptoms of tissue damage may be slow to appear.
    - b. Frostbite.
      - (1) Face, ears, and nose. Cover the casualty's affected area with his/her and/or your bare hands until sensation and color return.
      - (2) Hands. Open the casualty's field jacket and shirt. Place the affected hands under the casualty's armpits. Close the field jacket and shirt to prevent additional exposure.
- CAUTION**  
Do NOT remove clothing in a chemical environment.
- (3) Feet. Remove the casualty's boots and socks if he/she does not need to walk any further to receive additional treatment. Place the affected feet under clothing and against the body of another Soldier.

**WARNING**

Do NOT attempt to thaw the casualty's feet or other seriously frozen areas if the Soldier will be required to walk or travel to a medical center to receive medical treatment. The possibility of injury from walking is less when the feet are frozen than after they have been thawed (if possible, avoid walking). Thawing in the field increases the possibility of infection, gangrene, or injury.

*Note:* Thawing may occur spontaneously during transportation to the aid station or hospital. This cannot be avoided since the body in general must be kept warm.

- (4) Ensure that the casualty is kept warm and that he/she is covered (to avoid further injury).
  - (5) Seek medical treatment as soon as possible.
  - (6) Reassure the casualty, protect the affected area from further injury by covering it lightly with a blanket or any dry clothing, and seek shelter out of the wind.
  - (7) Remove or loosen constricting clothing (except in a contaminated environment) and increase insulation.
  - (8) Ensure that the casualty exercises as much as possible (avoiding trauma to the injured part) and is prepared for pain when thawing occurs.
  - (9) Protect the frostbitten part from additional injury. Do NOT—
    - (a) Rub the injured part with snow or apply cold water soaks.
    - (b) Warm the part by massage or exposure to open fire because the frozen part may be burned due to the lack of feeling.
    - (c) Use ointments or other salves.
    - (d) Manipulate the part in any way to increase circulation.
    - (e) Allow the Soldier to use alcohol or tobacco.
- c. Immersion foot/trench foot.

*Note:* First aid measures are required for all stages of immersion injury.

- (1) Rewarm the injured part gradually by exposing it to warm air.
- (2) Protect the part from trauma and secondary infections.
- (3) Use dry, loose clothing or several layers of warm coverings instead of extreme heat.

**WARNING**

Do NOT expose the injured part to an open fire.

- (4) Elevate the affected part.
- (5) Protect the part from additional injury. Do NOT—
  - (a) Massage the injured part.
  - (b) Moisten the skin.
  - (c) Apply heat or ice.



## Performance Steps

(6) Transport the casualty to a medical treatment facility as soon as possible.

d. Snow blindness.

(1) Cover the eyes with a dark cloth. If further exposure to light is not preventable, the eyes should be protected with dark bandages or the darkest glasses available.

(2) Evacuate the casualty to the nearest medical treatment facility.

e. Hypothermia.

(1) Early or moderate.

(a) Provide heat by using a hot water bottle or canteen filled with hot water and wrapped in cloth or by using another Soldier's body heat.

### CAUTION

Merely placing the casualty in a sleeping bag or covering with a blanket is NOT enough; the casualty is unable to generate his/her own body heat.

### CAUTION

Do NOT expose the casualty to an open fire; he/she may become burned.

(b) Call or send for help.

(c) Immediately remove all wet clothing from the casualty.

(d) Place the casualty in dry clothing and/or a sleeping bag.

(e) Move the casualty to a warm place.

(f) Evaluate other injuries and provide first aid, as required.

(First aid measures can be performed while the casualty is waiting for transportation or en route.)

(g) Evacuate the casualty to the nearest medical treatment facility.

(2) Severe.

(a) Start rescue breathing at once if the casualty's breathing has stopped or is irregular or shallow.

(b) Give warm liquids (not hot) gradually if the casualty is conscious.

### CAUTION

Do NOT force liquids on an unconscious or semiconscious casualty because he/she may choke.

(c) Evacuate to the nearest medical treatment facility as soon as possible.

**Note:** Rewarming a severely hypothermic casualty in the field is extremely dangerous. There is a great possibility of complications (such as rewarming shock and disturbance in the rhythm of the heartbeat).

f. Dehydration.

(1) Keep warm.

### Performance Steps

- (2) Loosen clothes to improve circulation unless in a chemical environment.
- (3) Provide shelter from the wind and cold.
- (4) Give fluids for fluid replacement.
- (5) Transport the casualty to a medical treatment facility as soon as possible.

**Evaluation Preparation:** *Setup:* Have a Soldier play the part of the cold injury casualty. Select one type of cold injury on which to evaluate the Soldier. Coach the simulated casualty on how to answer questions about symptoms. Physical signs and symptoms that the casualty cannot readily simulate (for example, blisters) must be described to the Soldier.

*Brief Soldier:* Tell the Soldier to determine the type of cold injury the casualty has. After the Soldier determines the cold injury, ask him/her to describe the proper treatment.

Performance Measures	GO	NO GO
1. Identified the type of cold injury.	___	___
2. Provided the proper first aid for the cold injury.	___	___

**Evaluation Guidance:** Refer to chapter 1, paragraph 1-9e, (1) and (2).

### References

#### Required:

**Related:** FM 4-25.11

## 081-831-1046

### Transport a Casualty

**Conditions:** You have evaluated and given first aid to a casualty. You need to move the casualty to get further medical aid and may have to remove him/her from a vehicle before transporting. Assistance from other Soldiers may be available. You will need material that will not cut or bind the casualty (cravat bandages or litter straps), poncho, shirts or jackets, and poles or tree limbs.

**Standards:** Transport the casualty using an appropriate carry or litter without dropping or causing further injury to the casualty.

### Performance Steps

1. Remove a casualty from a vehicle, if necessary.

#### WARNING

If the casualty was involved in a vehicle crash, you should always consider that he/she may have a spinal injury. Unless there is an immediate life-threatening situation (such as fire, explosion), do NOT move the casualty with a suspected back or neck injury. Seek medical personnel for guidance on how to transport the casualty.

## Performance Steps

**a.** Laterally.

(1) With the assistance of another Soldier, grasp the casualty's arms and legs.

(2) While stabilizing the casualty's head and neck as much as possible, lift the casualty free of the vehicle and move him/her to a safe place on the ground.

**Note:** If medical personnel are available, they may stabilize the casualty's head, neck, and upper body with a special board or splint.

**b.** Upward.

**Note:** You may have to remove a casualty upward from a vehicle; for example, from the passenger compartment of a wheeled vehicle lying on its side or from the hatch of an armored vehicle sitting upright.

(1) You may place a pistol belt or similar material around the casualty's chest to help pull him/her from the vehicle.

(2) With the assistance of another Soldier inside the vehicle, draw the casualty upward using the pistol belt or similar material or by grasping his/her arms.

(3) While stabilizing the casualty's head and neck as much as possible, lift the casualty free of the vehicle and place him/her on the topmost side of the vehicle.

**Note:** If medical personnel are available, they may stabilize the casualty's head, neck, and upper body with a special board or splint.

(4) Depending on the situation, move the casualty from the topmost side of the vehicle to a safe place on the ground.

**2.** Select an appropriate method to transport the casualty.

### WARNING

Do NOT use manual carries to move a casualty with a neck or spine injury, unless a life-threatening hazard is in the immediate area. Seek medical personnel for guidance on how to move and transport the casualty.

**a.** Fireman's carry. Use for an unconscious or severely injured casualty.

**b.** Neck drag. Use in combat, generally for short distances.

### CAUTION

Do NOT use the neck drag if the casualty has a broken arm or a suspected neck injury.

**c.** Cradle-drop drag. Use to move a casualty who cannot walk when being moved up or down stairs.

**d.** Use litters if materials are available, if the casualty must be moved a long distance, or if manual carries will cause further injury.

**3.** Transport the casualty.

**a.** Fireman's carry.

## Performance Steps

- (1) Kneel at the casualty's uninjured side.
- (2) Place casualty's arms above his/her head.
- (3) Cross the ankle on the injured side over the opposite ankle.
- (4) Place one of your hands on the shoulder farther from you and your other hand on his/her hip or thigh.
- (5) Roll the casualty toward you onto his/her abdomen.
- (6) Straddle the casualty.
- (7) Place your hands under the casualty's chest and lock them together.
- (8) Lift the casualty to his/her knees as you move backward.
- (9) Continue to move backward, thus straightening the casualty's legs and locking the knees.
- (10) Walk forward, bringing the casualty to a standing position but tilted slightly backward to prevent the knees from buckling.
- (11) Maintain constant support of the casualty with one arm. Free your other arm, quickly grasp his/her wrist, and raise the arm high.
- (12) Instantly pass your head under the casualty's raised arm, releasing it as you pass under it.
- (13) Move swiftly to face the casualty.
- (14) Secure your arms around his/her waist.
- (15) Immediately place your foot between his/her feet and spread them (approximately 6 to 8 inches apart).
- (16) Again grasp the casualty's wrist and raise the arm high above your head.
- (17) Bend down and pull the casualty's arm over and down your shoulder bringing his/her body across your shoulders. At the same time pass your arm between the legs.
- (18) Grasp the casualty's wrist with one hand while placing your other hand on your knee for support.
- (19) Rise with the casualty correctly positioned.

**Note:** Your other hand is free for use as needed.

### b. Neck drag.

#### **WARNING**

Do NOT use the neck drag if the casualty has a broken and/or fractured arm or a suspected neck injury. If the casualty is unconscious, protect his/her head from the ground.

- (1) Tie the casualty's hands together at the wrists. (If conscious, the casualty may clasp his/her hands together around your neck.)
- (2) Straddle the casualty in a kneeling face-to-face position.
- (3) Loop the casualty's tied hands over and/or around your neck.
- (4) Crawl forward, looking ahead, dragging the casualty with you.

## Performance Steps

### c. Cradle-drop drag.

- (1) With the casualty lying on his/her back, kneel at the head.
- (2) Slide your hands, palms up, under the casualty's shoulders.
- (3) Get a firm hold under his/her armpits.
- (4) Partially rise, supporting the casualty's head on one of your forearms.

*Note:* You may bring your elbows together and let the casualty's head rest on both of your forearms.

(5) With the casualty in a semisitting position, rise and drag the casualty backwards.

(6) Back down the steps (or up if appropriate), supporting the casualty's head and body and letting the hips and legs drop from step to step.

### d. SKED litter.

- (1) Remove the SKED from the pack and place on the ground.
- (2) Unfasten the retainer strap, step on the foot end of the SKED, and unroll it completely to the opposite end.
- (3) Bend the SKED in half and back roll. Repeat with the opposite end of the litter. The SKED litter will now lay flat.
- (4) Place the SKED litter next to the casualty. Ensure that the head end of the litter is adjacent to the head of the casualty. Place cross straps under the SKED.
- (5) Log roll the casualty and slide the SKED as far under him/her as possible. Gently roll the casualty down onto the SKED litter.
- (6) Slide the casualty to the center of the SKED litter. Be sure to keep the spinal column as straight as possible.
- (7) Pull the straps out from under the SKED litter.
- (8) Lift the sides of the SKED and fasten the four cross straps to the buckles directly opposite the straps.
- (9) Lift the foot portion of the SKED and feed the foot straps through the unused grommets at the foot end of the SKED and fasten to the buckles.

*Note:* The dragline is attached to the head portion of the SKED litter and used to transport the casualty off the battlefield.

### e. Improvised litter.

- (1) Use the poncho and two poles or limbs.
  - (a) Open the poncho and lay the two poles lengthwise across the center, forming three equal sections.
  - (b) Reach in, pull the hood up toward you, and lay it flat on the poncho.
  - (c) Fold one section of the poncho over the first pole.
  - (d) Fold the remaining section of the poncho over the second pole to the first pole.
- (2) Use shirts or jackets and two poles or limbs.

## Performance Steps

(a) Button two or three shirts or jackets and turn them inside out, leaving the sleeves inside.

(b) Lay the shirts or jackets on the ground and pass the poles through the sleeves.

(3) Place the casualty on the litter.

(4) Lift the litter.

(a) Raise the litter together.

(b) Keep the litter as level as possible.

**Note:** Use caution when transporting on a slope, incline, and/or hill.

**Evaluation Preparation:** *Setup:* For a one-man carry, you will need another Soldier to play the part of the casualty. If a vehicle is available, you can place the casualty in it to test step 1. Tell the casualty what the injuries are and whether he/she is conscious or unconscious. Obtain appropriate materials (strip of cloth, poles, branches, poncho, blanket, and so forth) as necessary to test the carries.

*Brief Soldier:* Tell the Soldier that the casualty has been given first aid. Describe a situation in terms of the casualty's injuries, whether the casualty is conscious or unconscious, whether enemy fire can be expected or not, and what distance the casualty must be moved. Tell the Soldier to transport the casualty using an appropriate carry or a litter.

**Note:** Do not make the situation too complex. Remember when scoring the Soldier, two or more of the carries might be appropriate for the situation. The most important thing is that the selected carry should not cause further injury to the casualty and should not endanger the lives of the two Soldiers.

Performance Measures	GO	NO GO
1. Removed the casualty from a vehicle, if necessary.	_____	_____
2. Selected an appropriate method of transporting the casualty.	_____	_____
3. Transported the casualty.	_____	_____
4. Did NOT cause further unnecessary injury.	_____	_____

**Evaluation Guidance:** Refer to chapter 1, paragraph 1-9e, (1) and (2).

## References

### Required:

**Related:** FM 4-25.11 and FM 8-10-6

## 081-831-1053

### Practice Individual Preventive Medicine Countermeasures

**Conditions:** You are a Soldier deployed to a unit in the field. The items you will need will vary depending on the physical environment and climate. They may include water, food, replacement clothing, lip balm, personal insect repellent, hand sanitizing gel, sunscreen, foot powder, soap, washcloth, baby wipes, own supply of toilet paper, toothbrush and toothpaste, shampoo, iodine tablets, and razor.

**Standards:** Apply preventive medicine countermeasures to protect, as appropriate, against cold, heat, biting insects, poisonous plants, animals, diseases from contaminated food and water, diseases from human waste, diseases from soil and common objects, sexually transmitted diseases (STD), and acquired immune deficiency syndrome (AIDS). Maintain personal hygiene and proper level of nutrition, take measures to resist stress, and avoid adverse effects of tobacco products.

#### Performance Steps

**Note:** Every Soldier should be issued and should maintain a supply of personal protection items. These items include lip balm, personal insect repellent, hand sanitizing gel, sunscreen, and foot powder.

1. Apply proper preventive medicine measures (PMMs) for protection against cold injuries.

a. Wear layers of loose clothing.

**Note:** Minimize sweating. When clothing becomes wet or dirty, it loses its ability to provide warmth.

b. Exercise to increase blood circulation.

(1) Tighten and relax arm and leg muscles, fingers, and toes.

(2) Use hands to massage and warm the face.

(3) Refrain from smoking because it restricts blood flow to the skin.

c. Change socks.

(1) Put on dry socks during rest breaks to reduce the risk of frostbite and trench foot.

#### WARNING

Severe frostbite and trench foot can result in the loss of hands or feet.

**Note:** Inactive feet in damp or wet socks and boots or tightly laced boots, which impair circulation, are even more susceptible to injury.

(2) Put damp socks inside the shirt to dry.

d. Prevent dehydration.

(1) Drink sufficient fluids (potable water, juices, and warm nonalcoholic beverages).

**Note:** Drinking a sufficient amount of potable water in cold weather is as important as it is in hot weather. In cold weather, you may not realize that your body is losing fluids and salt. Sweat evaporates rapidly or is absorbed so completely by the layers of clothing that it is seldom visible on the skin.

(2) Rest when possible.

2. Apply proper PMMs for protection against heat injuries.

a. Drink sufficient amounts of water.

**Note:** Your body needs a minimum amount of water for cooling, waste elimination, and metabolism. Any attempt to train the body to use less water can be harmful and may lead to heat injuries.

## Performance Steps

(1) Fluid intake should not exceed 1 ½ quarts of water every hour. Daily fluid intake should not exceed 12 quarts. If your urine is dark yellow, you are not drinking enough water.

(2) Fluid intake needs will vary depending on the type of work and the temperature (see figure 081-831-1053-1 and table 081-831-1053-1).

Examples of Categories of Work		
<i>Easy Work</i>	<i>Moderate Work</i>	<i>Hard Work</i>
<ul style="list-style-type: none"> <li>• Weapon maintenance.</li> <li>• Walking on hard surface at 2.5 mph, ≤ 30-pound load.</li> <li>• Manual of arms.</li> <li>• Marksmanship training.</li> <li>• Drill and ceremony.</li> </ul>	<ul style="list-style-type: none"> <li>• Walking on loose sand at 2.5 mph, no load.</li> <li>• Walking on hard surface at 3.5 mph, &lt; 40-pound load.</li> <li>• Calisthenics.</li> <li>• Patrolling.</li> <li>• Individual movement techniques, i.e. low crawl, high crawl.</li> <li>• Defensive position construction.</li> </ul>	<ul style="list-style-type: none"> <li>• Walking on loose sand at 2.5 mph with load.</li> <li>• Walking on hard surface at 3.5 mph, ≥ 40-pound load.</li> <li>• Field assaults.</li> </ul>

**Figure 081-831-1053-1. Categories of work**

**Table 081-831-1053-1. \*Fluid replacement policy**

Fluid Replacement Policy for Warm Weather (Average Acclimated Soldier Wearing BDU, Hot Weather)							
		Easy Work		Moderate Work		Hard Work	
Heat Category	WBGT Index, °F	Work/ Rest	Water Intake, Qt/Hr	Work/ Rest	Water Intake, Qt/Hr	Work/ Rest	Water Intake, Qt/Hr
1*	78 – 81.9	NL	½	NL	¾	40/20 min	¾
2 (green)	82 – 84.9	NL	½	50/10 min	¾	30/30 min	1
3 (yellow)	85 – 87.9	NL	¾	40/20 min	¾	30/30 min	1
4 (red)	88 – 89.9	NL	¾	30/30 min	¾	20/40 min	1
5** (black)	>90	50/10 min	1	20/40 min	1	10/50 min	1

**CAUTION**

Hourly Fluid Intake Should Not Exceed 1½ Quarts. Daily Fluid Intake Should Not Exceed 12 Quarts.

\*The work/rest times and fluid replacement volumes will sustain performance and hydration for at least 4 hours of work in the specified heat category. Individual water needs will vary ± ¼ quart per hour.

\*NL = no limit to work time per hour. Rest means minimal physical activity (sitting or standing) and should be accomplished in shade if possible.

\*Wearing body armor adds 5° F to WBGT Index.

\*Wearing ALL MOPP overgarments adds 10° F to WBGT Index.

\*\*Suspend physical training and strenuous activity. If an operational (nontraining) mission requires strenuous activity, enforce water intake to minimize expected heat injuries.

(3) Drink extra water before combat operations.

(4) Maintain excess water in your system for strength and alertness.

(5) Protect yourself from dehydration and heat injuries associated with wearing full chemical protective gear.

b. Rest whenever possible.



## Performance Steps

(1) Take rest breaks in accordance with the heat condition table, as the tactical situation permits.

(2) Use rest breaks to drink water and to cool off. Take a cool shower, if possible.

c. Eat meals.

(1) Eat regular meals daily to replace salt lost through heavy sweating.

(2) Eat something at each meal, even if you are not hungry.

*Note:* Usually, eating field rations or liberal salting of the garrison diet will provide enough salt. Excess intake of salt should be avoided.

(3) Do NOT take herbal-type medications, diet supplements, or performance-enhancing drugs.

d. Protect yourself from exposure.

(1) Wear your uniform properly.

(2) Use shade whenever possible.

(3) Use barrier creams and lotions.

3. Apply proper PMMs for protection against arthropod (insect) bites and arthropod-borne diseases.

a. Apply extended-duration arthropod repellent lotion to exposed skin, ankles, and waistline.

b. Apply insect repellent to your uniform (if not treated with permethrin).

c. Keep sleeves down and trouser legs tucked into boots to protect from biting insects.

d. Check yourself and your buddy for ticks twice a day.

4. Apply proper PMMs for protection against poisonous plants and animals.

a. Look inside sleeping bag before getting in.

b. Look inside boots before putting them on.

c. Keep sleeves down and trouser legs tucked into boots to protect from poisonous plants.

d. Do not play with snakes.

5. Apply proper PMMs for protection against diseases from contaminated food and water.

a. Drink water from approved sources only.

b. Eat from approved sources only.

*Note:* Street vendors are never approved food sources as they are not inspected by U.S. military preventive medicine or veterinary personnel. Foods consumed from street vendors can cause severe illness in U.S. troops.

## Performance Steps

6. Apply proper PMMs for protection against diseases from human waste.
  - a. A cat-hole is dug to use for excreting waste if your unit is on the move. Cover it sufficiently to prevent flies from spreading germs from the waste to your food and to keep unwanted animals out of your bivouac area.
  - b. The straddle trench latrine is used on short bivouacs and field training exercises—1 to 3 days duration.
  - c. Deep pit latrines are constructed for temporary camps that are more than 3 days.
  - d. Individual waste collection bags may be used on the march, on convoys, or for small groups in isolated areas. It is important to seal and transport the waste with you until it can be burned or buried safely.
  - e. The pail latrine and the burn-out latrine are constructed when chemical toilets are not available, the ground is too hard, or the soil is very wet. The latrine is burned out daily by adding sufficient fuel to incinerate the excrement. The contents are burned until they are dry and odorless. Any remaining ash should be buried.
7. Apply proper PMMs to protect against diseases from soil and common objects.
  - a. Wash your hands regularly to defend against germs from the soil and from objects handled by other people. Wash your hands—
    - (1) After using the latrine.
    - (2) Before touching eating utensils or food.
    - (3) After eating.
    - (4) After handling any item that can potentially transfer germs.
    - (5) Frequently during the work day to keep your hands free of germs.
  - b. Cleaning your hands with hand-sanitizing gel is an effective way to disinfect them from nearly all germs that cause illnesses. You should use soap and water to wash your face and to bathe the rest of your body.
8. Maintain personal hygiene on the move.
  - a. While in the field or deployed, you will not always have ready access to your rucksack. Always carry these items with you:
    - (1) A bar of soap and a washcloth or baby wipes.
    - (2) Your own supply of toilet paper or baby wipes.
    - (3) Your toothbrush and toothpaste.
    - (4) Shampoo.
  - b. If shower or laundry facilities are not available, use plastic wash bins or other containers to bathe or wash clothing, if you have an adequate water supply.
  - c. Sprinkle foot powder in your socks to help absorb the moisture.

## Performance Steps

- d. Remove the inserts from your boots at night to prevent fungus from growing.
- e. If you get athlete's foot, you will need an antifungal solution or cream to treat it.
- f. Wear one pair of boots one day and change to your other pair the next day.
- g. Use boot/sock liners for road marches greater than 5 km (3.1 mi) to prevent blisters.

*Note:* Boot/sock liners are your military issued black dress socks worn underneath your military black boot socks.

### 9. Maintain your level of nutrition.

*Note:* Soldiers typically do not eat enough when they are in the field or deployed; they lose weight, and they lose their edge on physical and mental performance.

- a. Your meal, ready to eat (MRE) is the standard individual ration for operations.

*Note:* There are 24 different menus. The MRE contains cooked entrees and other food items that require no preparation. It will sustain the Soldier engaged in heavy activity, such as field training and deployed missions, when normal food service facilities are not available. One MRE provides an average of 1,300 calories, consisting of 13% protein, 36% fat, and 51% carbohydrates.

- b. It is important to eat at least some of each item in the MRE, even if you are not hungry.

### 10. Take measures to resist stress.

- a. Fear and physical signs or symptoms of stress are normal reactions before and during combat or other dangerous/life-threatening situations. You should not let fear or stress keep you from doing your job.

- b. Talk about what is happening with your buddies, especially during after-action debriefings.

- c. Learn ways to relax quickly.

- d. Integrate new replacements into your unit and get to know them quickly.

- e. If you must join a new unit, be active in establishing friendships.

### 11. Protect against sexually transmitted diseases (STDs).

- a. Use a condom (rubber).

*Note:* Individuals should use a condom during vaginal, anal, or oral sex when there is a possibility of acquiring an infection.

## Performance Steps

- b. Avoid high-risk sexual behaviors. Such behaviors include—
  - (1) Having more than one sexual partner.
  - (2) Changing sex partners frequently.
  - (3) Having sex with casual partners, prostitutes, or their clients.
  - (4) Having anal sex.
- c. Control alcohol intake (it affects your ability to use safe sex practices).

### 12. Protect against human immunodeficiency virus (HIV), the virus that causes AIDS.

**Note:** HIV is contagious in the same way STDs are contagious. Infection can result from a sexual relationship with an infected person. Sexual contact is not the only way to contract HIV, but it is a major contributor.

a. Prevent sexual transmission—know your partner. Avoid having sex with persons who might be infected with HIV. At highest risk are those who have more than one sex partner or who have unprotected sex with casual partners, prostitutes, or their clients; partners who are HIV infected or who share needles with others.

b. Prevent transmission through shared needles or syringes—do not use injected, nonprescribed drugs.

**Note:** Although progress has been made in research and medications, it is important to remember that there is presently no cure for AIDS and no vaccine to prevent HIV infection.

### 13. Avoid adverse effects of tobacco products.

a. Using tobacco affects your ability to function when you are in the field or deployed.

b. Smoking has tactical hazards:

(1) Cigarette smoke can be detected up to 300 meters downwind by the enemy.

(2) The flame can be detected by enemy snipers.

(3) There are possibilities of starting a fire.

c. Smoking can be hazardous to a Soldier's health, even if it is a buddy who is smoking. The long-term adverse effects of using tobacco include chronic diseases of the heart and lungs, cancer, stroke, and high blood pressure.

d. Short-term effects can cut into your effectiveness in performing your mission. Such effects include—

(1) Watering eyes.

(2) Runny nose.

(3) Coughing.

(4) Loss of smell and taste.

(5) Increased heart rate (up to 30%).

**Performance Steps**

- (6) More easily fatigued.
- (7) Elevation in blood pressure (up to 15%).
- (8) Decreased appetite.
- (9) Diarrhea, constipation, or both.
- (10) Reduced stamina.
- (11) Decreased ability to recover from illness and injury.
- (12) Decreased blood circulation to the brain.
- (13) Decreased night vision (20 to 25%)

**Evaluation Preparation:** *Setup:* Evaluate this task during a field training exercise (FTX) or during a normal training session. If the evaluation is conducted during an FTX, use the environmental and physical conditions at the FTX as the scenario to implement preventive medicine countermeasures. If the evaluation is done during a normal training session, create the scenario to include environmental and physical conditions. Develop a series of questions to guide the Soldier through the appropriate performance measures.

*Brief Soldier:* Tell the Soldier he/she will be evaluated on his/her ability to apply the appropriate preventive medicine countermeasures.

<b>Performance Measures</b>	<b>GO</b>	<b>NO GO</b>
1. Applied proper PMMs to protect against the cold.	___	___
2. Applied proper PMMs to protect against the heat.	___	___
3. Applied proper PMMs to protect against arthropod bites and arthropod-borne diseases.	___	___
4. Applied proper PMMs to protect against poisonous plants and animals.	___	___
5. Applied proper PMMs to protect against diseases from contaminated food and water.	___	___
6. Applied proper PMMs to protect against diseases from human waste.	___	___
7. Applied proper PMMs to protect against diseases from soil and common objects.	___	___
8. Maintained personal hygiene on the move.	___	___
9. Maintained the proper level of nutrition.	___	___
10. Took measures to resist stress.	___	___
11. Knew how to protect against sexually transmitted diseases.	___	___
12. Knew how to protect against AIDS.	___	___
13. Avoided adverse effects of tobacco products.	___	___

**Evaluation Guidance:** Refer to chapter 1, paragraph 1-9e, (1) and (2).

## References

### Required:

**Related:** AR 600-63, FM 21-10, and FM 4-25.11

**SUBJECT AREA 3: CHEMICAL, BIOLOGICAL, RADIOLOGICAL,  
AND NUCLEAR**

## 031-503-1013

### Decontaminate Yourself and Individual Equipment Using Chemical Decontaminating Kits

**Conditions:** You are at mission-oriented protective posture (MOPP) 2. You are given TM 3-4230-229-10, a protective mask, protective gloves, a full canteen of water, a poncho, load-bearing equipment (LBE), and decontaminating kit(s). Your skin has been exposed to chemical agents, or you have passed through a chemically contaminated area.

**Standards:** Decontaminate yourself and your individual equipment using the chemical decontaminating kits. Start the steps to decontaminate your skin and eyes within 1 minute after contamination. Decontaminate your exposed skin and eyes, as necessary, before chemical-agent symptoms occur. Decontaminate all individual equipment after decontaminating your skin and eyes.

#### Performance Steps

1. Assume MOPP3 (don your protective mask in addition to MOPP2).
2. Decontaminate your skin using the M291 decontaminating kit.

#### CAUTION

The M291 decontaminating kit is for external use only. Keep decontaminating powder out of your eyes and any cuts or wounds because the decontaminating powder may irritate your skin or eyes. Use water to wash the toxic agent out of your eyes, cuts, or wounds.

#### DANGER

**Death or injury may result if you breathe toxic agents while decontaminating your face. If you need to breathe before you finish, reseal your mask, clear it, check it, get your breath, and then resume the decontaminating procedure.**

**Note:** After decontaminating with water, cover exposed cuts or wounds with appropriate first aid wrap or bandages before handling the decontaminating kit.

#### CAUTION

Do not handle or hold leaking packets above your head. Do not touch or rub your eyes, lips, or the inside of your mouth with anything that has been in contact with the decontaminating powder.

## Performance Steps

### CAUTION

Do not attempt to decontaminate a loaded weapon. Always unload and clear the weapon and place the weapon on safe before starting decontaminating procedures. Immediate decontaminating techniques remove only the liquid hazard. Certain items may still present a vapor hazard. See your supervisor for unmasking procedures.

- a. Decontaminate your hands and face and the inside of your mask.
  - (1) Remove one skin decontamination packet from your carrying pouch.
  - (2) Tear it open quickly at the notch.
  - (3) Remove the applicator pad from the packet, and discard the empty packet.
  - (4) Unfold the applicator pad, and slip your finger(s) into the handle.
  - (5) Scrub the back of your hand, palm, and fingers until they are completely covered with black powder from the applicator pad.
  - (6) Switch the applicator pad to the other hand, and repeat the procedure.

**Note:** Do not discard the applicator pad at this time.

**Note:** If you were masked with your hood zipped and the drawstring pulled tight when you were contaminated, stop. Discard the applicator pad, put on your protective gloves, and go to step 2b below. However, if you were masked, but the zipper and drawstring were not secure, go to step 2a(16) below.

**Note:** The stars in the illustration on page 2-5 of TM 3-4230-229-10 show areas of the face that should be scrubbed with an extra stroke because they are hard to decontaminate.

**Note:** The procedure is the same regardless of the type of protective mask used. If you are using the new style chemical-protective overgarment with a hood attached to the protective jacket, ignore the instructions for the hood.

### DANGER

**Death or injury may result if you breathe toxic agents while doing the following step. If you need to breathe before you finish, reseal your mask, clear it, check it, get your breath, and then resume the decontaminating procedure.**

- (7) Scrub exposed skin of your face thoroughly until you are completely covered with black powder from the applicator pad.
- (8) Hold your breath, close your eyes, grasp the mask beneath your chin, and pull the hood and mask away from your chin enough to allow one hand between the mask and your face.
- (9) Scrub up and down across your face, beginning at the front of one ear, to your nose, and then to your other ear.
  - (a) Scrub across your face to the corner of your nose.
  - (b) Scrub an extra stroke at the corner of your nose.
  - (c) Scrub across your nose, to the tip of your nose, and then to the other corner of your nose.

## Performance Steps

(d) Scrub an extra stroke at the corner of your nose.

(e) Scrub across your face to your other ear.

(10) Scrub up and down across your face to your mouth and then to the other end of your jawbone.

(a) Scrub across your cheek to the corner of your mouth.

(b) Scrub an extra stroke at the corner of your mouth.

(c) Scrub across your closed mouth to the center of your upper

lip.

(d) Scrub an extra stroke above your upper lip.

(e) Scrub across your closed mouth to the outer corner of your

mouth

(f) Scrub an extra stroke at the corner of your mouth.

(g) Scrub across your cheek to the end of your jawbone.

(11) Scrub up and down across your face to your chin and then to the other end of your jawbone.

(a) Scrub across and under your jaw to your chin, cupping your chin.

(b) Scrub extra strokes at the center of your chin.

(c) Scrub across your upper jaw to the end of your jawbone.

(12) Turn your hand out, and quickly wipe the inside of your mask where it touches your face.

(13) Discard the applicator pad.

(14) Seal your mask immediately, clear it, and check it.

(15) Remove the second skin decontamination packet from the carrying pouch.

(16) Repeat steps 2a (2), (3), and (4) above.

(17) Scrub your neck and ears until they are thoroughly covered with black powder without breaking the seal between your face and your mask. Scrub your hands again until they are completely covered with black powder.

(18) Discard the applicator pad.

b. Assume MOPP4. (Put on protective gloves and fasten your hood in addition to MOPP3).

c. Remove the decontaminating powder with soap and water when operational conditions permit.

3. Decontaminate your individual equipment using the M295 decontaminating kit.

a. Use the first mitt to decontaminate your gloves, the exposed areas of your mask and hood, your weapon, and your helmet.

(1) Remove one decontamination packet from your pouch.



## Performance Steps

- (2) Tear the packet open at any notch.
  - (3) Remove the decontamination mitt.
  - (4) Discard the empty packet.
  - (5) Unfold the decontamination mitt.
  - (6) Grasp the green (nonpad) side of the decontamination mitt with your nondominant hand. Pat the other gloved hand with the decontamination mitt to start the flow of decontamination powder onto your glove. Rub your glove with the decontamination mitt until it is completely covered with decontaminating powder.
  - (7) Insert the decontaminated, gloved hand inside the decontamination mitt. Ensure that the pad side is in the palm of your hand and your thumb sticks through the appropriate thumbhole. Securely tighten the wristband on the gloved hand.
  - (8) Decontaminate individual equipment by rubbing with the pad side of the decontamination mitt until the equipment is thoroughly covered with decontamination powder. Pay special attention to areas that are hard to reach (such as cracks, crevices, and absorbent materials).
    - (a) Decontaminate your other glove.
    - (b) Decontaminate exposed areas of your mask and hood.
    - (c) Decontaminate your weapon.
    - (d) Decontaminate your helmet by patting it with the decontamination mitt.
  - (9) Discard the decontamination mitt.
- b.** Use the second mitt to decontaminate your LBE and accessories, mask carrier, overboots, and gloves again.
- (1) Get another packet, and repeat steps 3a(1) through 3a(7). Then, perform the following:
    - (a) Decontaminate load-carrying equipment (LCE) and accessories (such as canteen, ammunition pouch, and first aid pouch).
    - (b) Decontaminate your mask carrying case.
    - (c) Decontaminate your protective boots.
    - (d) Repeat the decontamination process on your protective gloves.
  - (2) Discard the decontamination mitt.
  - (3) Get another packet and repeat steps 3a(1) through 3a(7) if liquid contamination is still suspected or detected. Rub or blot areas where contamination is still suspected or detected.

### WARNING

The M295 kit only removes the liquid hazard. Decontaminated items may still present a vapor hazard. Do not unmask until it has been determined that it is safe to do so.

## Performance Steps

- c. Remove the decontaminating powder when operational conditions permit.
4. Dispose of hazardous waste materials.
  - a. Dispose of uncontaminated hazardous waste materials.
    - (1) Dispose of expended or unserviceable materials according to federal, state, and local laws; military regulations and publications; host-nation laws (if more restrictive than United States [US] laws); and local standing operating procedures (SOPs).
    - (2) Place used decontaminating materials in a sealed plastic bag, and label it with the contents. Give the bag to your supervisor.
  - b. Dispose of contaminated hazardous waste materials. Inform your supervisor of the status of contaminated hazardous waste.

**Evaluation Preparation:** *Setup:* Provide the Soldier with the items listed in the task conditions statement. A good time to evaluate this task is while in a field environment. Gather materials for the disposal of hazardous waste according to federal, state, and local rules and regulations.

*Brief Soldier:* Tell the Soldier what body parts and equipment are contaminated.

Performance Measures	GO	NO GO
1. Assumed MOPP3.	___	___
2. Decontaminated skin using the M291 decontaminating kit.	___	___
3. Decontaminated individual equipment using the M295 decontaminating kit.	___	___
4. Disposed of hazardous waste materials.	___	___

**Evaluation Guidance:** Refer to chapter 1, paragraph 1-9e, (1) and (2).

### References

**Required:** TM 3-4230-229-10

**Related:** FM 3-11.4, FM 3-5, and TM 10-8415-209-10

## 031-503-1015

### Protect Yourself From Chemical, Biological, Radiological, and Nuclear (CBRN) Injury or Contamination with Mission-Oriented Protective Posture (MOPP) Gear

**Conditions:** You are given mission-oriented protective posture (MOPP) gear, FM 3-11.4, TM 3-4240-279-10, TM 3-4240-280-10, and one of the following situations in a chemically contaminated tactical environment:

1. You are ordered to achieve MOPP4.
2. You learn that a chemical attack is about to happen.
3. You must enter an area where chemical agents have been used.

4. You recognize a chemical hazard.
5. You are attacked with chemical agents without warning.

**Note:** If you are equipped with the joint-Service, lightweight integrated suit technology (JSLIST), use task number 031-503-1040 instead of this task. This task was developed for the older battle dress overgarment (BDO).

**Standards:** Protect yourself from CBRN injury or contamination with MOPP gear. Perform all steps in sequence, and achieve MOPP4 within 8 minutes.

### Performance Steps

1. Put on gear for MOPP1.
  - a. Don the trousers.
    - (1) Put the overgarment trousers on over your normal duty uniform or, in hot weather, over your undergarments.
    - (2) Secure the trousers by snapping and zipping them and adjusting the waistband for a snug fit.
    - (3) Do NOT fasten the bottom of the trousers at this time.
  - b. Secure the jacket to the trousers by snapping the three snaps across the back of the jacket to the trousers.
  - c. Don the jacket
    - (1) Put on the overgarment jacket.
    - (2) Zip it up.
    - (3) Fasten the snaps.
2. Put on the protective overboots to reach MOPP2.

**Note:** Go to Step 2a if you are putting on the older-model chemical protective footwear cover (CPFC). (The overboots have a single eyelet at the rear.)

**Note:** Go to Step 2b if you are putting on the newer-model CPFC. (The overboots have two rear eyelets.)

**Note:** Go to Step 2c if you have green or black vinyl overboots.

- a. Put the older-model CPFC overboots on over your leather combat boots, lacing them according to the instructions provided in the package.
    - (1) Smooth the excess material as flat as possible.
    - (2) Lace the overboots.
    - (3) Don the cover on either foot by centering your foot on the sole.
    - (4) Thread the lace through the front eyelet so that the ends are the same length.
    - (5) Tie a single hitch by passing one lace end through each eyelet from the inside to the outside, drawing each lace end tight.
    - (6) Pass both ends through the rear eyelet from the inside to the outside.
    - (7) Bring the ends back through the side eyelets.
    - (8) Tighten the lace by working the slack out of it between the side and back eyelets.
- Note:** The lace should hold the rear eyelet firmly against the boot.
- (9) Tie the lace tightly across the instep with a single hitch.

## Performance Steps

(10) Wrap the excess lace around your leg, tying the ends with a reef or bow knot.

b. Put the newer-model CPFC overboots on over your leather combat boots, lacing them according to the instructions provided in the package.

(1) Don the cover on either foot by centering your foot on the sole.

(2) Tuck the excess front material under the front of your foot.

(3) Lace the overboots.

(a) Thread the lace through the front eyelet so that both ends are the same length.

(b) Pass each lace end through a side eyelet from the inside to the outside.

(c) Draw the laces up tightly, fastening them with a single knot.

(d) Pass the ends through the rear eyelets from the inside to the outside.

(e) Pull the lace up firmly, positioning the fish tails neatly at the sides of your ankle.

(f) Tie the lace firmly with a single knot in front.

(g) Wrap the loose lace ends around your leg, tying them firmly in front with a bow knot and tucking in the loose ends.

**Note:** The newer model method is being taught at the United States (US) Army Chemical School. Units that still have the older model should continue to use the older-model donning instructions.

c. Put the green or black vinyl overboots on over the leather combat boots, securing them by pulling the rubber bands around the metal buttons.

d. Blouse the overgarment trouser legs over the chemical-protective overboots.

e. Secure the overgarment trouser legs by pulling the zipper down, tying the drawstring, and securing the hook-and-pile closure.

3. Put on the protective mask with hood to reach MOPP3.

a. Don the protective mask.

b. Don the hood.

c. Zip up the hood (M17-series protective mask only).

d. Adjust the neck cord.

e. Attach the underarm straps.

**Note:** The time standards for masking do not apply to step 3.

4. Put on additional gear to reach MOPP4.

### Performance Steps

- a. Put on the mask. (This posture is not appropriate when a blister agent is present.)
- b. Secure your MOPP gear by zipping all zippers and closing all closures.
- c. Put on the chemical-protective gloves (rubber gloves and liners).
- d. Pull the elastic cuffs of the overgarment jacket sleeves over the cuffs of the chemical-protective gloves.

**Evaluation Preparation:** *Setup:* Evaluate this task during a field exercise or normal training session. Gather all necessary MOPP gear, and ensure that it is in good condition. Be ready to direct higher MOPP levels as a Soldier reaches each level.

*Brief Soldier:* Tell the Soldier he/she will be donning MOPP gear to achieve MOPP4. The Soldier will be directed to go to the higher MOPP level as each level is reached. He/she must be able to complete steps 1 through 4 in 8 minutes or less.

Performance Measures	GO	NO GO
1. Put on gear for MOPP1.	_____	_____
2. Put on protective overboots to reach MOPP2.	_____	_____
3. Put on the protective mask with hood to reach MOPP3.	_____	_____
4. Put on additional gear to reach MOPP4.	_____	_____
5. Completed steps 1 through 4 in 8 minutes or less.	_____	_____

**Evaluation Guidance:** Refer to chapter 1, paragraph 1-9e, (1) and (2).

### References

**Required:** FM 3-11.4, TM 3-4240-279-10, and TM 3-4240-280-10

**Related:** TM 10-8415-209-10, TM 3-4240-300-10-2, TM 3-4240-312-12&P, and TM 3-4240-346-10

## 031-503-1018

### React to Nuclear Hazard/Attack

**Conditions:** You are in a tactical situation or an area where nuclear weapons have been (or may have been) used. You are given load-bearing equipment (LBE), a piece of cloth or a protective mask, a brush or a broom, shielding material, FM 3-3-1, and one of the following situations:

1. You see a brilliant flash of light.
2. You find a standard radiological contamination marker or an enemy marker.
3. You are told that fallout is in your area.
4. You receive instructions to respond to a nuclear attack.
5. You come across a suspected depleted-uranium (DU) hazard.

#### CAUTION

Do NOT use masks with damaged filters because certain models contain hazardous materials. Do NOT change the filter in a contaminated environment.

**Standards:** React to a nuclear hazard or attack with or without warning and without becoming a casualty. Identify radiological contamination markers with 100 percent accuracy, and notify your supervisor. Start the steps to decontaminate yourself within 1 minute of finding radiological contamination. Decontaminate individual equipment after completely decontaminating yourself.

**Performance Steps**

1. React to a nuclear attack without warning.
  - a. Close your eyes immediately.
  - b. Drop to the ground in a prone position, facing the blast.

*Note:* If you are in the hatch of an armored vehicle, immediately drop down inside the vehicle.

- c. Keep your head and face down and your helmet on.
  - d. Stay down until the blast wave passes and debris stops falling.
  - e. Cover your mouth with a cloth or similar item to protect against inhaling dust particles.
  - f. Check for casualties and damaged equipment.

2. React to a nuclear attack with warning.
  - a. Select the best available shelter.
    - (1) Move into a fighting position, bunker, or ditch.
    - (2) Take protective actions if you are inside a shelter.
    - (3) Remain in place if you are in an armored vehicle.

- b. Protect your eyes.
  - c. Minimize exposed skin areas.
  - d. Cover your mouth with a cloth or similar item to protect against inhaling dust particles.

3. React to a radiological contamination marker.

- a. Avoid the area, if possible.
  - b. Cross the area quickly by the shortest route that exposes you to the least amount of radiation based on mission, enemy, terrain, troops, time available, and civil considerations (METT-TC).

- (1) Request crossing instructions through the chain of command if you must cross.

- (2) Maximize the use of shielding.

- (3) Cover your mouth with a cloth or similar item to protect against inhaling dust particles. A protective mask may be used if nothing else is available.

- c. Identify radiological contamination markers with 100 percent accuracy, and report the discovery of any identified markers to your supervisor.

## Performance Steps

4. Remove radiological contamination (including DU) from your clothing, equipment, and exposed skin.
  - a. Shake or brush contaminated dust (all dust is considered to be radioactive) from your clothing, equipment, and exposed skin with a brush or a broom. If a brush or a broom is not available, use your hands.
  - b. Wash your body as soon as possible, giving special attention to hairy areas and underneath your fingernails.
  - c. Conduct mission-oriented protection posture (MOPP) gear exchange if you are contaminated with wet radioactive contamination and were previously ordered to maintain a MOPP level.

**Evaluation Preparation:** *Setup:* Evaluate this task during a field exercise, if possible. Select an area that provides several shelters that the Soldier can choose from (an open area, a shallow ditch, a depression, or a foxhole with overhead cover). Evaluate the Soldier's reaction to a nuclear attack without warning (brilliant flash of light) and with warning by having him/her stand in an open area with the nearest possible shelter no closer than 12 feet. You may simulate the attack by saying "Brilliant flash" or by using the flash attachment of a camera. Tell the Soldier that there will be a nuclear detonation within 2 minutes and to take the best available shelter. Evaluate the Soldier's ability to react to radiological contamination markers by telling him/her to walk through the area (where a standard marker and a former Warsaw Pact marker have been placed) and take appropriate action. Evaluate the Soldier's ability to remove radiological contamination.

*Brief Soldier:* Tell the Soldier that a nuclear attack is imminent and that he/she must react to a nuclear attack with and without warning. Tell the Soldier that he/she must also react to nuclear contamination markers. Tell the Soldier that after being exposed to nuclear radiation, he/she must perform the decontamination steps.

Performance Measures	GO	NO GO
1. Reacted to a nuclear attack without warning.	_____	_____
2. Reacted to a nuclear attack with warning.	_____	_____
3. Reacted to a radiological contamination marker.	_____	_____
4. Removed radiological contamination (including DU) from clothing, equipment, and exposed skin.	_____	_____

**Evaluation Guidance:** Refer to chapter 1, paragraph 1-9e, (1) and (2).

### References

**Required:** FM 3-3-1

**Related:** FM 3-5

## 031-503-1019

### React to Chemical or Biological (CB) Hazard/Attack

**Conditions:** You are in mission-oriented protective posture 1 (MOPP1) gear. You are given DA Form 1594 (*Daily Staff Journal or Duty Officer's Log*), FM 3-11.4, TM 3-4230-229-10, TM 3-4230-235-10, a protective mask, an individual decontaminating kit, a tactical environment in which CB weapons have been (or may be) used by the enemy, and one or more of the following automatic-masking situations occur:

1. A chemical alarm sounds.
2. A positive reading is obtained on detector paper.
3. Individuals exhibit symptoms of CB-agent poisoning.
4. You observe a contamination marker.
5. Your supervisor tells you to mask.
6. You see personnel wearing protective masks.
7. You observe other signs of a possible CB attack.

**Standards:** React to a CB hazard/attack without becoming a casualty. Identify and notify your supervisor of chemical contamination markers with 100 percent accuracy. Start the steps to decontaminate yourself within 1 minute of finding chemical contamination. Decontaminate your individual equipment after you have completely decontaminated yourself.

#### Performance Steps

1. Identify the CB hazard automatic-masking criteria.
  - a. Don your protective mask when there is a high probability of a chemical attack, such as—
    - (1) A chemical alarm sounds.
    - (2) A positive reading is obtained on detector paper.
    - (3) Individuals exhibit symptoms of CB-agent poisoning.
    - (4) You observe a contamination marker.
    - (5) Your supervisor tells you to mask.
    - (6) You see personnel wearing protective masks.
    - (7) You observe other signs of a possible CB attack.
  - b. Respond to the commander's policy of automatic masking.

**Note:** Commanders at all levels may establish a modified policy by designating additional events as automatic-masking criteria.

2. Protect yourself from CB contamination by using your assigned protective mask without fastening the hood.

**Note:** The mask gives immediate protection against inhaling agent vapors. Do not fasten the hood. Go to the next step immediately.

3. Give the alarm.
  - a. Shout "Gas."
  - b. Give the appropriate hand-and-arm signal.



## Performance Steps

4. Take cover to reduce exposure by using whatever means is readily available.
5. Decontaminate exposed skin using the individual decontaminating kit, as necessary.
6. Assume MOPP4. Cover all your skin (your head and shoulders are already protected by the mask and the overgarment).
  - a. Put on gloves with liners.
  - b. Zip and fasten the overgarment jacket.
  - c. Secure the hood, and then secure the overgarment to increase protection.
  - d. Put on the overboots.

**Note:** Combat boots provide protection but should be covered because they absorb chemicals. It takes a long time to put on the overboots, so in an emergency, put them on last.

7. Decontaminate individual equipment using the individual decontaminating kit, as necessary.
8. Notify your supervisor of any CB hazard markers or indicators.
9. Continue the mission.
10. Assume MOPP4 and perform all tasks according to the unit standing operating procedure (SOP).
11. Use all means of CB detection to check your surrounding area for the presence of contamination.
12. Contact your higher headquarters if you do not find contamination or if you determine the attack was non-CB.
13. Await further guidance. The higher headquarters contacts all adjacent/attached units to check the status of CB contamination in their areas. If all units report the absence of contamination, the information is reported up the chain of command.
14. Annotate the above actions on DA Form 1594.

---

**Evaluation Preparation:** *Setup:* A good time to evaluate this task is during a field exercise when a variety of CB hazards can be simulated. Select a site with adequate cover, and ensure that Soldiers are in MOPPI.

*Brief Soldier:* Tell the Soldier that there will be an encounter with simulated CB contamination and/or a CB alarm will be given. Tell the Soldier that the task is to recognize the hazard and/or alarm, to take appropriate actions to protect him or herself, and to warn other Soldiers by giving the appropriate alarm.

Performance Measures	GO	NO GO
1. Identified the CB hazard automatic-masking criteria.	_____	_____
2. Protected him or herself from CB contamination by using the assigned protective mask without fastening the hood.	_____	_____
3. Gave the alarm.	_____	_____
4. Took cover to reduce exposure by using whatever means were readily available.	_____	_____
<i>Note:</i> Only the fact that the Soldier decontaminates him or herself is evaluated. The actual conduct of decontamination is evaluated in task 031-503-1013.		
5. Decontaminated exposed skin, as necessary.	_____	_____
<i>Note:</i> Only the fact that the Soldier assumes MOPP4 is evaluated. The actual donning of MOPP gear is evaluated in task 031-503-1015.		
6. Assumed MOPP4.	_____	_____
7. Decontaminated individual equipment, as necessary.	_____	_____
8. Notified the supervisor of any CB hazard markers or indicators.	_____	_____
9. Continued the mission.	_____	_____

**Evaluation Guidance:** Refer to chapter 1, paragraph 1-9e, (1) and (2).

#### References

**Required:** DA Form 1594, FM 3-11.4, TM 3-4230-229-10, and TM 3-4230-235-10

**Related:** FM 3-5

## 031-503-1024

### Replace Canister on Your M40-Series Protective Mask

**Conditions:** You are assigned an M40 or M42 protective mask. You have a defective filter canister and a replacement canister.

**Standards:** Without damaging the mask, remove the defective canister and install a new canister on the M40 or M42 protective mask so that the mask will be operational.

#### Performance Steps

1. Replace a canister on an M40 protective mask.
  - a. Remove the canister by unscrewing it counterclockwise from the facepiece.

## Performance Steps

- b. Check the connectors of the new canister, the mating surfaces of the facepiece, and the areas between these surfaces for dirt or other debris which would allow contaminated air into your facepiece.
- c. Check the expiration date on the new canister to ensure the canister has not expired.

### WARNING

An expired canister will not filter toxic agents.

- d. Insert the new canister into the side port of the facepiece.
  - e. Tighten the canister by screwing it clockwise. The canister will be hand tightened only.
2. Replace a canister on an M42 protective mask.
- a. Remove the canister carrier cover by pressing in and rotating it counterclockwise.
  - b. Remove the canister by unscrewing it counterclockwise from the hose and removing it from the canister carrier.
  - c. Check the connectors of the new canister, the mating surfaces of the facepiece, and the areas between these surfaces for dirt or other debris which would allow contaminated air into your facepiece.
  - d. Check the expiration date on the new canister to ensure the canister has not expired.

### WARNING

An expired canister will not filter toxic agents.

- e. Insert the canister into the canister carrier.
- f. Make sure the gasket is in the canister connection before connecting the canister to the hose.

### WARNING

A missing gasket will affect the seal and will allow the wearer to inhale contaminated air.

- g. Attach the canister to the hose.
  - (1) Position the hose on the canister.
  - (2) Tighten the canister by screwing it clockwise into the hose while holding the hose securely.
- h. Attach the canister carrier cover to the carrier.

## Performance Steps

- (1) Position the canister carrier cover on the canister carrier.
- (2) Press in on the canister carrier cover while rotating it clockwise.

**Evaluation Preparation:** *Setup:* Evaluate this task during a field exercise or during normal maintenance of the mask. Place all of the necessary equipment on a field table or suitable substitute. During training and evaluation sessions, reuse an old canister several times to avoid expending new canisters each time.

*Brief Soldier:* Tell the Soldier to replace the canister on either an M40 or an M42 protective mask, as appropriate. Evaluate the Soldier on this task only if the Soldier is assigned an M40 or an M42 protective mask.

Performance Measures	GO	NO GO
1. Replaced a canister on an M40 protective mask.	_____	_____
a. Removed the canister by unscrewing it counterclockwise from the facepiece.		
b. Checked the connectors of the new canister, the mating surfaces of the facepiece, and the areas between these surfaces for dirt or other debris which would allow contaminated air into the facepiece.		
c. Checked the expiration date on the new canister to ensure that the canister had not expired.		
d. Inserted the new canister into the side port of the facepiece.		
e. Tightened the canister by screwing it clockwise (hand tightened only).		
2. Replaced a canister on an M42 protective mask.	_____	_____
a. Removed the canister carrier cover by pressing in and rotating it counterclockwise.		
b. Removed the canister by unscrewing it counterclockwise from the hose and removing it from the canister carrier.		
c. Checked the connectors of the new canister, the mating surfaces of the facepiece, and the areas between these surfaces for dirt or other debris which would allow contaminated air into the facepiece.		
d. Checked the expiration date on the new canister to ensure that the canister had not expired.		
e. Inserted the canister into the canister carrier.		
f. Made sure the gasket was in the canister connection before connecting the canister to the hose.		

Performance Measures	GO	NO GO
<p><b>g.</b> Attached the canister to the hose.</p> <p style="padding-left: 40px;"><b>(1)</b> Positioned the hose on the canister.</p> <p style="padding-left: 40px;"><b>(2)</b> Tightened the canister by screwing it clockwise into the hose while holding the hose securely.</p> <p><b>h.</b> Attached the canister carrier cover to the carrier.</p> <p style="padding-left: 40px;"><b>(1)</b> Positioned the canister carrier cover on the canister carrier.</p> <p style="padding-left: 40px;"><b>(2)</b> Pressed in on the canister carrier cover while rotating it clockwise.</p>		

**Evaluation Guidance:** Refer to chapter 1, paragraph 1-9e, (1) and (2).

## 031-503-1035

### Protect Yourself from Chemical and Biological (CB) Contamination Using Your Assigned Protective Mask

**Conditions:** You are given your assigned protective mask with a hood and carrier, a canteen with an M1 cap, M8 detector paper, FM 3-3, and one of the following applicable TMs: TM 3-4240-279-10, TM 3-4240-280-10, TM 3-4240-300-10-2, TM 3-4240-312-12&P, or TM 3-4240-346-10. You find yourself in one of the following situations:

1. You hear or see a CB attack.
2. You realize, through other means, that you are under a CB attack.
3. You are ordered to mask.
4. You must enter a contaminated area.

After having donned your protective mask, you need to drink from your canteen.

**Special Conditions:** Do NOT wear contact lenses when performing this task. Do NOT use masks with damaged filters because certain models contain hazardous materials. Do Not change filter elements in a contaminated environment.

**Standards:** Protect yourself from CB contamination using your assigned protective mask; don, clear, and check your mask within 9 seconds; and drink water through your protective mask from your canteen without becoming a casualty.

#### Performance Steps

1. Complete steps 2 through 4 within 9 seconds.
2. Don the mask.
  - a. Stop breathing, and close your eyes.
  - b. Remove your helmet.
    - (1)** If you have the M17-, M24-, M25-, M40-, M43-, or M45-series protective mask, put your helmet between your legs (above your knees) or hold your rifle between your legs and place your helmet on the muzzle. If you drop your helmet, continue to mask.

## Performance Steps

(2) If you have the M42-series protective mask, remove your helmet and place it in a convenient location. Avoid placing it on a contaminated surface, if possible.

### WARNING

Do not wear contact lenses with the protective mask. Remove contact lenses when the use of chemical agents is imminent.

- c. Take off your glasses, if applicable.
- d. Open the mask carrier with one hand.
- e. Grasp the mask assembly with your other hand, and remove it from the carrier.
- f. Put your chin in the chin pocket, and press the face piece snugly against your face.

*Note:* The temple and forehead straps have already been adjusted during fitting.

g. Grasp the tab, and pull the head harness over your head. Ensure that your ears are between the temple straps and the cheek straps. Ensure that the head harness is pulled far enough over your head so that the forehead straps are tight.

h. Use one hand to tighten the cheek straps, one at a time, while holding the head pad centered on the back of your head with the other hand. Ensure that the straps lay flat against your head.

### 3. Clear the mask.

- a. Seal the outlet valve by pushing in on the center of the outlet valve cover with one hand.
- b. Blow out hard to ensure that any contaminated air is forced out around the edges of the face piece.

### 4. Check the mask.

- a. Cover the inlet port of the filter canister (M40 and M45 series) or the inlet port of the armor quick disconnect (M42 series) with the palm of your hand, and inhale.
- b. Ensure that the face piece collapses against your face and remains so while you hold your breath, which indicates that the mask is airtight.
- c. Remove any hair, clothing, or other matter between your face and the mask if the face piece does not collapse to your face.
- d. Notify your chemical, biological, radiological, and nuclear (CBRN) noncommissioned officer (NCO) if the mask still does not collapse.

### 5. Resume breathing.

*Note:* There are no time standards for donning the hood.

## Performance Steps

### 6. Secure the mask hood.

#### CAUTION

Be careful when pulling on the hood because it could snag and tear on the buckles of the head harness.

a. If you have the M17-, M25-, M42-, or M43-series protective mask, pull the hood over your head and zip the front closed to cover all bare skin.

b. If you have the M24- or M45-series protective mask, pull the M7 hood over your helmet and head so that the hood covers your shoulders.

c. If you have the M40-series protective mask, don the hood so that it lies smoothly on your head.

(1) For masks equipped with the regular hood—

(a) Grasp the back edge of the hood skirt.

(b) Pull the hood completely over your head so that it covers the back of your head, neck, and shoulders.

(c) Zip the front of the hood closed by pulling the zipper slider downward.

(d) Tighten the draw cord.

(e) Secure the underarm straps by fastening and adjusting them.

(f) Close your mask carrier.

(g) Continue your mission.

(2) For masks equipped with the quick-off hood—

(a) Place your hands inside the hood and expand the elastic gathering around the neck of the hood.

(b) Stretch and carefully pull the hood over your head so that the hood covers your head, neck, and shoulders.

(c) Fasten the underarm straps.

(d) Put on the helmet.

**Note:** If you have a combat vehicle crewman (CVC) helmet, perform the following steps:

- Disconnect the boom microphone from the helmet.
- Connect the mask microphone to the receptacle in the helmet.
- Grasp the helmet next to the ear cups with your hand, and spread the helmet as far as possible.
- Place the helmet over your head, tilting the helmet forward slightly so that the first contact when putting it on is with the forehead surface of the mask.
- Rotate the helmet back and down over your head until it is seated in position.

(e) Close your mask carrier.

## Performance Steps

- (f) Continue your mission.

**Note:** If the Soldier is using the mask in conjunction with the joint-Service, lightweight integrated suit technology (JSLIST), he/she skips this step (the mask lacks a hood because it is built in the JSLIST).

7. Drink water while wearing the mask (only applies to masks equipped with a drinking tube).

### WARNING

Do not connect the quick-disconnect coupling to your canteen until all surfaces are free of contamination. Chemical contamination could enter your mouth, and you could become a casualty.

### WARNING

Do not break the mask seal while drinking from the canteen.

- a. Press in on the top of the outlet valve cover until the internal drink tube can be grasped between your teeth.
- b. Steady the mask assembly, and pull the quick-disconnect coupling out of the outlet valve cover.
- c. Flip open the cover on the M1 canteen cap.
- d. Push the quick-disconnect coupling into the canteen cap so that the pin enters the quick-disconnect coupling.

### WARNING

If resistance is not felt, your drinking system is leaking. Do not drink. Replace your canteen. If resistance is still not felt, notify your CBRN NCO.

- e. Blow to create positive pressure. You should feel some resistance.
- Note:** Do not tilt your head back while drinking.
- f. If the system does not leak, raise the canteen upside down and drink.
  - g. Stop drinking after several swallows, and lower the canteen. Blow into the internal drink tube to prevent the canteen from collapsing. Repeat the drinking procedure as required.
8. Remove the mask for storage.
  9. Perform all steps in sequence without becoming a casualty.

---

**Evaluation Preparation:** *Setup:* Evaluate this task during a field exercise or a tactical training session. Use a mask previously fitted to the Soldier's face. The Soldier will bring his/her flight or CVC helmet. The Soldier should be in mission-oriented protective posture 4 (MOPP4). Do not use a new decontamination kit for every Soldier; use the kit as long as possible. Ensure that the Soldier has M8 detector paper in the mask carrier before testing. If the Soldier has not made



adequate progress towards drinking from the canteen after 2 minutes, stop him/her and give the Soldier a NO GO. This time standard is administrative.

*Brief Soldier:* Tell the Soldier to stand, while wearing his/her mask carrier containing the assigned protective mask with the hood attached. Provide the Soldier with one of the scenarios described in the conditions statement (cue to begin masking). Tell the Soldier to keep the mask on until you issue the all clear order. Tell the Soldier that all time standards are for administrative (noncombat) evaluation purposes only. Tell the Soldier to drink water while wearing the assigned mask.

Performance Measures	GO	NO GO
1. Completed steps 2 through 4 within 9 seconds.	_____	_____
2. Donned the mask.	_____	_____
3. Cleared the mask.	_____	_____
4. Checked the mask.	_____	_____
5. Resumed breathing.	_____	_____
6. Secured the mask hood.	_____	_____
7. Drank water while wearing the mask.	_____	_____
8. Removed the mask for storage.	_____	_____
9. Performed all steps in sequence without becoming a casualty.	_____	_____

**Evaluation Guidance:** Refer to chapter 1, paragraph 1-9e, (1) and (2).

### References

**Required:** FM 3-11.4, FM 3-3, TM 3-4240-279-10, TM 3-4240-280-10, TM 3-4240-300-10-2, and TM 3-4240-346-10

**Related:** TM 3-4240-312-12&P

## 031-503-1036

### Maintain Your Assigned Protective Mask

**Conditions:** You have used your assigned protective mask or must conduct a scheduled mask inspection. You are given your assigned protective mask (with authorized accessories and components); a container of warm, soapy water; soap; a container of warm, clear water; cheese cloth or clean rags; a small cleaning brush; alcohol; optical lens cleaning compound (National Stock Number [NSN] 6850-00-592-3283); the applicable supply bulletin, the applicable technical manual (TM): TM 3-4240-279-10 (M17), TM 3-4240-280-10 (M24), TM 3-4240-300-10-2 (M42), TM 3-4240-312-12&P (M43), or TM 3-4240-346-10 (M40A1); DA Form 2404 (*Equipment Maintenance and Inspection Worksheet*) or DA Form 5988-E (*Equipment Maintenance and Inspection Work Sheet Electronic*); spare parts for the masks; and a set of replacement filters (M17-series mask) or a replacement canister. This task cannot be performed in mission-oriented protective posture 4 (MOPP4).

**Standards:** Maintain your assigned protective mask. Ensure that you—

1. Perform preventive maintenance checks and services (PMCS) on the mask according to the applicable TM.

2. Clean and dry the mask.
3. Do not damage the mask.
4. Record uncorrected deficiencies on DA Form 2404 or DA Form 5988-E, and report them to your supervisor.

#### Performance Steps

#### WARNING

Do not attempt to remove the hose from the face piece on the M42 protective mask. This may cause leakage of toxic agents in the face mask.

#### CAUTION

Do not dunk the mask or carrier in water.

#### CAUTION

Wash the mask carefully so that the canister and microphone do not get wet.

#### CAUTION

Ensure that all components are entirely dry before reassembling the mask and storing it.

**Note:** Each Soldier must care for and maintain his/her protective mask.

**Note:** Keep water away from the inlet valve connectors.

1. Conduct operator PMCS on the protective mask, carrier, hood, and accessories according to the TM applicable to your assigned protective mask.
  - a. Identify deficiencies and shortcomings.
  - b. Correct operator deficiencies.
  - c. Record all uncorrected deficiencies and shortcomings on DA Form 2404 or DA Form 5988-E, and report them to your supervisor.
2. Clean and dry the mask, hood, and authorized accessories and components according to the TM applicable to your assigned protective mask.
3. Store the mask, hood, and accessories in the carrier according to the TM applicable to your assigned protective mask.
4. Perform steps 1 through 4 without damaging the mask.

**Evaluation Preparation:** *Setup:* Evaluate this task during normal care and cleaning of the mask. Place the required equipment on a field table or another suitable surface. Simulate defects in the mask by removing components from the mask or using a defective mask not issued to the Soldier. During training and evaluation sessions, use an old set of filters or canister several times to avoid expending new ones each time. If the Soldier has not made adequate progress towards completing the task within 30 minutes, stop the Soldier and give him or her a NO GO. This time standard is administrative.

**Brief Soldier:** Tell the Soldier there is no time standard for this task on the job, but for testing purposes, he/she must perform the task within 30 minutes. Tell the Soldier to perform operator PMCS on the mask, clean and condition the assigned protective mask, and replace the filters in the mask. Tell the Soldier that finishing a DA Form 2404 or DA Form 5988-E is not part of the task.

Performance Measures	GO	NO GO
1. Conducted operator PMCS on the protective mask, carrier, hood, and accessories according to the applicable TM.	_____	_____
2. Cleaned and dried the mask, hood, and authorized accessories and components according to the applicable TM.	_____	_____
3. Replaced defective components and parts according to the TM applicable to your assigned protective mask.	_____	_____
4. Stored the mask, hood, and accessories in the carrier according to the applicable TM.	_____	_____
5. Performed steps 1 through 4 without damaging the mask.	_____	_____

**Evaluation Guidance:** Refer to chapter 1, paragraph 1-9e, (1) and (2).

**References**

**Required:** DA Form 2404, DA Form 5988-E, TM 3-4240-279-10, TM 3-4240-280-10, TM 3-4240-300-10-2, TM 3-4240-312-12&P, TM 3-4240-346-10

**Related:**

## 031-503-1037

### Detect Chemical Agents Using M8 or M9 Detector Paper

**Conditions:** You are in mission oriented protective posture 2 (MOPP2) in a tactical environment or an area where there is a chemical threat. You are given a protective mask, a booklet of M8 detector paper, a dispenser of M9 detector paper, an M256A1 chemical-agent detector kit, the assigned decontaminating kit (M291 or M295), DA Form 1594 (*Daily Staff Journal or Duty Officer's Log*), FM 3-11.4, FM 3-3, TM 3-6665-307-10, TM 3-6665-311-10, and a complete set of MOPP gear or a chemical-protective ensemble.

**Special Conditions:** Do NOT wear contact lenses when performing this task. Do NOT use masks with damaged filters because certain models contain hazardous materials. Do NOT change the filter element in a contaminated environment.

**Standards:** Detect chemical agents using M8 and M9 detector paper. Ensure that the M9 detector paper is attached to places likely to come into contact with liquid chemical agents. Detect and identify all liquid chemical agents in the area that are within the capabilities of the M8 or M9 detector paper without becoming a casualty.

#### Performance Steps

#### WARNING

Always wear protective gloves when touching M9 detector paper. Do not get M9 detector paper in or near your mouth or on your skin. The M9 detector paper dye may cause cancer, but the risk is small because very little dye is used.

1. Detect chemical agents using M9 detector paper.

**WARNING**

M8 and M9 detector paper will NOT detect chemical-agent vapors.

a. Attach the M9 detector paper to your MOPP gear and equipment while wearing chemical-protective gloves.

(1) Place the M9 detector paper on the MOPP gear on opposite sides of your body.

(a) If you are right-handed, place a strip of M9 detector paper around your right upper arm, left wrist, and right ankle.

*Note:* These are the places where a moving Soldier will most likely brush against a surface (such as undergrowth) that is contaminated with a liquid chemical agent.

(b) If you are left-handed, place a strip of M9 detector paper around your left upper arm, right wrist, and left ankle.

*Note:* Do not attach M9 detector paper to hot, dirty, oily, or greasy surfaces because it may give a false positive reading.

(2) Place M9 detector paper on equipment where it will come in contact with contaminated objects, and it is visible to the operator.

**WARNING**

Some decontaminants will give false positive results on the M8 detector paper. The M8 detector paper may indicate positive results if used in an area where decontaminants have been used.

b. Monitor the M9 detector paper constantly for any color change. If you observe a color change, immediately do the following:

- (1) Mask.
- (2) Give the alarm.
- (3) Decontaminate as necessary.
- (4) Assume MOPP4.

2. Detect chemical agents using M8 detector paper if you see a liquid that might be a chemical agent or if you observe a color change on the M9 detector paper.

a. Assume MOPP4 immediately.

b. Prepare the M8 detector paper. Tear out a sheet from the booklet (if it is perforated, use one-half of the sheet).

*Note:* To avoid possible contamination, put the paper on the end of a stick or another object and then blot the paper on the suspected liquid agent.

c. Blot (do not rub) the M8 detector paper on the suspected liquid agent. Do not touch the liquid with your protective glove.

## Performance Steps

- d. Observe the M8 detector paper for a color change. Identify the contamination by comparing any color change on the M8 detector paper to the color chart on the inside front cover of the booklet.
- (1) A yellow-gold color indicates the presence of a nerve (G) agent.
  - (2) A red-pink color indicates the presence of a blister (H) agent.
  - (3) A dark green color indicates the presence of a nerve (V) agent.
  - (4) Any other color or no color change indicates that the liquid cannot be identified using M8 detector paper.
- e. Store the booklet of M8 detector paper.
- f. Remain in MOPP4 even if the liquid cannot be identified. Use other types of chemical-agent detector kits to verify the test results.
- g. Notify your supervisor of the test results.

**Note:** M8 detector paper reacts positive to petroleum products, ammonia, and decontaminating solution number 2 (DS2). M9 detector paper reacts positive to petroleum products, insecticides, and antifreeze. Because M9 detector paper only detects (but does not identify) chemical agents, verify all readings with M8 detector paper. If you observe a color change on M8 or M9 detector paper, assume it is a liquid chemical agent. Confirm the presence of contamination by using all means of chemical-agent detection available in your area of operation, including a visual check of your surroundings. If you determine that your reading is a false positive, perform the following actions before giving the all clear signal:

1. Ensure that every attempt has been made to recheck the area.
2. Contact your higher headquarters (HQ) or the person in charge, and report the negative results.
3. Await further guidance. The higher HQ contacts all adjacent/attached units to check the status of contamination in their areas. If all units report the absence of contamination, the information is reported up the chain of command.
4. Annotate the above actions on DA Form 1594.

---

### Evaluation Preparation:

#### CAUTION

Ensure that simulants are placed on detector paper only and never on the protective clothing.

**Setup:** Provide the items listed in the task condition statement. Simulate an unknown liquid chemical agent by using expedient training aids (such as brake fluid, cleaning compound, gasoline, insect repellent, or antifreeze). Place drops of the simulated agent on M9 detector paper to obtain a reading. For M8 detector paper, place the simulated agent on nonporous material (such as an entrenching tool).

**Brief Soldier:** Tell the Soldier that he/she will be entering an area where chemical agents have been used. Tell him to attach M9 detector paper to his/her MOPP gear and equipment. Tell him that if you observe any acts that are unsafe or that could produce a false reading you will stop the test and he/she will be scored a NO GO.

Performance Measures	GO	NO GO
1. Detected chemical agents using M9 detector paper.	_____	_____
2. Detected chemical agents using M8 detector paper.	_____	_____

**Evaluation Guidance:** Refer to chapter 1, paragraph 1-9e, (1) and (2).

**References**

**Required:** DA Form 1594, FM 3-11.4, FM 3-3, TM 3-6665-307-10, and TM 3-6665-311-10

**Related:**

## 031-503-1040

### Protect Yourself from CBRN Injury/Contamination with the JSLIST Chemical Protective Ensemble

**Conditions:** You are given the joint-Service, lightweight, integrated suit (JSLIST) chemical-protective ensemble, a protective mask, FM 3-11.4, and TM 10-8415-220-10. You learn that a chemical attack is about to happen. You must enter an area where chemical agents have been used, you must recognize a chemical hazard, or you are attacked with chemical agents without warning.

**Standards:** Protect yourself from chemical, biological, radiological, and nuclear (CBRN) injury/contamination with the JSLIST chemical-protective ensemble by achieving mission oriented protective posture 4 (MOPP4) within 8 minutes, performing all steps in sequence, and returning to MOPP0 when ordered.

#### Performance Steps

1. Don the MOPP gear.
  - a. Don the overgarment trousers.
    - (1) Extend your toes downward, put one leg into the trousers, and pull them up. Repeat the procedure for your other leg.
    - (2) Close the slide fastener, and fasten the two fly opening snaps.
    - (3) Pull the suspenders over your shoulders, and fasten the snap couplers. Adjust the suspenders to ensure that the trousers fit comfortably.

*Note:* The trouser length can be adjusted by raising or lowering the suspenders.

  - (4) Adjust the waistband hook-and-pile fasteners for a snug fit.
- b. Don the overgarment coat.
  - (1) Don the coat, and close the slide fastener up as far as your chest.
  - (2) Secure the front closure hook-and-pile fasteners up as far as your chest.
  - (3) Pull the bottom of the coat down over the trousers.
  - (4) Pull the ends of the coat retention cord through the front of the coat to fit around your waist, and tie the ends into a bow.
- c. Don the overboots.
  - (1) Don the overboots over the combat boots. Adjust and secure the strap-and-buckle fasteners.

## Performance Steps

(2) Pull the trouser legs over the multipurpose overboots (MULO). Secure the hook-and-pile fasteners on each ankle to fit snugly around the boot.

*Note:* If the MULO are not available, use black vinyl overboots (BVOs), which are the current rain boots that are also used for chemical-biological (CB) protection.

d. Don the chemical-protective mask.

(1) Adjust the head harness, and check for a good seal.

(2) Pull the hood over your head and the chemical-protective mask.

Close the slide fastener completely. Secure the hook-and-pile fastener tape closure up as far as the top of the slide fastener.

(3) Place the edge of the hood around the edge of the mask, and secure the hook-and-pile fastener tape.

(4) Snap the barrel locks together; squeeze both ends of the barrel lock while pulling the draw cord, and simultaneously slide the barrel lock up to your chin.

(5) Have a buddy check the hood seal around your mask to ensure that the hood is positioned properly and that skin is not exposed (tie the excess draw cord into a bow, if necessary).

### WARNING

To prevent the barrel lock from unfastening and possibly exposing the user to contamination, the barrel lock release button must face away from the user.

(6) Untie the bow in the coat retention cord. Bend over, reach between your legs, and grasp the coat retention cord loop. Bring the loop forward between your legs, pulling on it so that the bottom of the coat fits snugly over the trousers.

(7) Place the coat retention cord loop over the webbing strip at the bottom of the coat, fasten the webbing strip, and snap it to keep the retention cord loop in place. Some discomfort may be experienced in the crotch area due to the coat retention cord.

*Note:* The waistband can be readjusted by tying a bow in the coat retention cord at the front of your waist, if necessary.

e. Don the gloves.

(1) Push the sleeves up your arm.

(2) Don the gloves (and liners if butyl rubber gloves are used).

(3) Pull the cuffs over the gloves, and secure the hook-and-pile fastener tape snugly on each wrist.

*Note:* Perform the following doffing procedures to return to MOPPO.

2. Doff the MOPP gear.

a. Doff the gloves.

(1) Unfasten the hook-and-pile fastener tape on each wrist, and remove the gloves (and liners if butyl rubber gloves are worn).

(2) Put the gloves in the trouser pockets.

## Performance Steps

- b. Untie the bow in the coat retention cord, unfasten the webbing strip snap, and release the coat retention cord loop.
  - c. Do off the helmet and cover if worn.
  - d. Do off the hood from the coat.
    - (1) Unfasten the barrel locks.
    - (2) Loosen the hood.
    - (3) Unfasten the hook-and-pile fastener tape at your neck.
    - (4) Pull the hood off your head.
  - e. Do off the protective mask, stow it in the carrier, and remove the carrier.
  - f. Do off the boots.
    - (1) Unfasten the ankle hook-and-pile fastener tapes.
    - (2) Unfasten the two strap-and-buckle fasteners on the MULO.
    - (3) Remove the MULO.
  - g. Do off the coat.
    - (1) Unfasten the front closure flap hook-and-pile fastener tape and the front slide fastener.
    - (2) Remove the coat.
  - h. Do off the trousers.
    - (1) Unfasten the suspender and waist hook-and-pile fastener tapes.
    - (2) Unfasten the front closure snaps, and open the slide fastener.
    - (3) Remove the trousers.
3. Perform after use, preventive maintenance checks and services (PMCS) inspections according to TM 10-8415-220-10.
  4. Remove the clear plastic, resealable bags from the trousers pocket. Fold and repack the coat and trousers in individual clear plastic, resealable bags.

**Evaluation Preparation:** *Setup:* Provide the Soldier with the items listed in the task condition statement. Evaluate this task during a field exercise or during a normal training session. Gather all the necessary MOPP gear, and ensure that all gear is in good condition. The evaluator must be prepared to direct higher MOPP levels immediately as a Soldier reaches a preceding level.

*Brief Soldier:* Tell the Soldier to rapidly assume the various MOPP levels.

Performance Measures	GO	NO GO
1. Donned the MOPP gear.	_____	_____
2. Doffed the MOPP gear.	_____	_____
3. Performed after use, PMCS inspections according to TM 10-8415-220-10.	_____	_____



Performance Measures	GO	NO GO
4. Removed the clear plastic, resealable bags from the trousers pocket. Folded and repacked the coat and trousers in individual clear plastic, resealable bags.	_____	_____

**Evaluation Guidance:** Refer to chapter 1, paragraph 1-9e, (1) and (2).

**References**

**Required:** FM 3-11.4 and TM 10-8415-220-10

**Related:** FM 3-3, FM 3-5, FM 4-25.11, and FM 8-285

## 031-503-1042

### Protect Yourself from CBRN Injury/Contamination When Changing MOPP (Using JSLIST)

**Conditions:** You are in mission oriented protective posture (MOPP) 4 with load-bearing equipment (LBE). Your MOPP gear is contaminated. Your buddy is in MOPP4 with LBE and is available to assist you with MOPP gear exchange. You have an uncontaminated set of MOPP gear for yourself and your buddy, a personal decontamination kit, an M295 individual equipment decontamination kit (IEDDK), FM 3-11.4, long-handled scrub brushes, cutting tools, super tropical bleach (STB), a chemical-agent monitor (CAM), 3-gallon pails, sponges, paper towels, soap, and water. This task will be performed in MOPP4.

**Standards:** Protect yourself from chemical, biological, radiological, and nuclear (CBRN) injury/contamination when changing MOPP using the joint-Service lightweight integrated suit technology (JSLIST). Decontaminate individual gear and equipment without spreading contamination onto your skin or undergarments. Set uncontaminated gear aside on an uncontaminated surface. Change overgarments, overboots, and gloves without spreading contamination to the uncontaminated set of MOPP gear. Change MOPP gear without you or your buddy becoming a casualty.

**Note:** If the environment is chemically or biologically contaminated, omit steps 2 and 4b in the training information outline below. If the environment is radiologically contaminated, omit steps 1 and 4a. If the environment is radiologically and chemically and/or biologically contaminated, perform all steps.

#### Performance Steps

**Note:** Both Soldiers will perform steps 1 and 2 at the same time. If, during the technique, you suspect that contamination has spread onto your skin or undergarments, decontaminate immediately with the available IEDDK, and then proceed with the MOPP gear exchange.

1. Decontaminate individual gear for chemical or biological contamination without assistance.
  - a. Remove and discard the chemical protective helmet cover.
  - b. Cover the gear with STB slurry paste.
  - c. Brush or rub the STB slurry paste into the material.
  - d. Shake the excess off gently.

## Performance Steps

- e. Set the gear aside on an uncontaminated surface (such as a poncho, a canvas, or similar material).
2. Decontaminate individual gear for radiological contamination without assistance.
    - a. Brush, wipe, or shake off the dust for radiological contamination from the individual gear.
    - b. Wash the equipment with warm, soapy water.
    - c. Set the equipment aside to dry on an uncontaminated surface.
  3. Prepare for decontamination.
    - a. Buddy: Remove the M9 paper; untie the bow in the coat retention cord, if tied; unfasten the webbing strip snap at the bottom front of the coat; and release the waist coat retention cord loop.
    - b. Buddy: Loosen the bottom of the coat by pulling the material away from the body.
    - c. Feel for the suspender snap couplers on the outside of the coat, and release the snap couplers.
    - d. Unfasten the hook-and-pile fasteners at the wrist and ankles, and refasten them loosely.
    - e. Unfasten the two strap-and-buckle fasteners on the multipurpose overboots (MULO) and unfasten or cut the fasteners on the black vinyl overboots (BVOs), or untie/cut the laces on the chemical-protective overboots.
  4. Decontaminate the mask and hood.
    - a. Chemical or biological contamination.
      - (1) The buddy uses M295 to decontaminate the exposed parts of the mask, instructing the Soldier to put two fingers on the voicemitter to avoid breaking the seal.
      - (2) The buddy starts at the eye lens outserts and wipes all exposed parts of the mask.
      - (3) The buddy wipes the front edge of the hood, including the barrel locks and fasteners under your chin.
      - (4) The buddy decontaminates his/her gloves in preparation to release the hood seal.
    - b. Radiological contamination.
      - (1) The buddy wipes your mask with warm, soapy water.

*Note:* Cool, soapy water is not as effective for removing contamination, but it can be used if the material is scrubbed longer.
      - (2) The buddy rinses your mask with a sponge dipped in clean water.
      - (3) The buddy dries your mask with paper towels or rags.

## Performance Steps

(4) The buddy decontaminates his/her gloves in preparation to release the hood seal.

5. Doff the chemical-protective coat.

a. The buddy unties the draw cord, if tied, presses the barrel lock release, and unsnaps the barrel locks.

*Note:* If the buddy has difficulty grasping the barrel locks, use the draw cord to pull the locks away from the mask, allowing the buddy to grasp and unfasten the locks without touching the hood's interior.

b. The buddy unfastens the front closure flap and slides the fastener from the chin to the bottom of the coat.

c. The buddy instructs the Soldier to turn around, grasps the hood, and rolls it inside out (pulling the hood off the Soldier's head).

d. The buddy grasps the coat at the shoulders and instructs the Soldier to make a fist to prevent the chemical-protective gloves from coming off.

e. The buddy pulls the coat down and away from the Soldier, ensuring that the black part of the coat is not touched.

*Note:* If it is difficult to remove the coat in this manner, pull one arm off at a time.

f. The buddy lays the coat on the ground, black side up.

### CAUTION

Both Soldiers must avoid contaminating the inside surface of the coat because it will be used later as an uncontaminated surface to stand on during the donning procedures.

6. Doff the chemical-protective trousers.

a. Unfasten the hook-and-pile fastener tapes at the waistband, unfasten the two front closure snaps, and open the fly slide fastener on the front of the trousers.

b. Buddy: Grasp the trousers at the hips, and pull them down to the knees.

c. Buddy: Have the Soldier lift one leg (with the foot pointed down). With your hand on each side, pull the trousers in an alternating motion until the Soldier can step out of the trouser leg. Repeat the process for the other leg.

d. Discard the trousers away from the clean area.

### CAUTION

Both Soldiers must avoid contaminating their clothing and skin.

7. Doff the chemical-protective overboots.

a. Buddy: Remove the chemical-protective overboots while the Soldier is standing with his/her arms up, shoulder high, to avoid contaminating the clothing or skin.

## Performance Steps

**Note:** The Soldier may put a hand on the buddy for balance, but he/she must then decontaminate the gloves.

- b. Stand next to the coat spread on the ground.
- c. Remove one overboot by stepping on a heel with one foot while pulling the other foot upward.
- d. Buddy: Pull off the Soldier's overboots, one foot at a time.
- e. As each foot is withdrawn from the overboot, step on the coat that is spread on the ground.
- f. Discard the overboots away from the clean area.

### CAUTION

The buddy must avoid touching the Soldier's combat boots. The Soldier must avoid letting the combat boots touch the ground.

8. Doff the chemical-protective gloves and liners.
  - a. Hold the fingertips of the gloves, and partially slide your hand out.
  - b. Hold your arms away from your body when both hands are free. Let the gloves drop off and away from the black side of the coat.
  - c. Remove the protective glove inserts.
  - d. Buddy: Discard the Soldier's chemical-protective gloves and inserts away from the clean area.

### CAUTION

Both Soldiers must avoid letting the gloves make contact with the coat that is spread on the ground.

9. Don the chemical-protective trousers.
  - a. Buddy: Open the package containing the new trousers, but do not touch the inside of the package.
  - b. Stand on the uncontaminated surface. Reach into the package, and remove the trousers without touching the outside of the package.
  - c. Put on the trousers, close the slide fastener, and fasten the two fly opening snaps. Pull the suspenders over your shoulders, and fasten the snap couplers.
  - d. Adjust the length of the suspenders to ensure that you have a comfortable fit in the inseam.
  - e. Adjust the hook-and-pile fasteners at the waistband for a snug fit.

### CAUTION

The Soldier must ensure that the trousers touch only the uncontaminated surface.

10. Don the chemical-protective coat.

## Performance Steps

**a.** Buddy: Open the package containing the new coat, and have the Soldier reach in and remove the coat. The Soldier must not touch the outside of the package.

**b.** Don the coat. Close the slide fastener up as far as the chest, and secure the front closure hook-and-pile fastener tape on the front flap as far as the chest.

**c.** Pull the bottom of the coat down over the trousers. Grasp the loop on the back of the overgarment coat, pull the loop out and away from the overgarment coat, and bring the loop forward between your legs, pulling on the loop so that the bottom of the coat fits snugly over the trousers.

**d.** Place the loop over the webbing strip on the front of the coat, and fasten the strap on the webbing strip to keep the loop in place. Adjust the retention cord on the coat, if necessary. Tie any excessive cord into a bow.

### CAUTION

The Soldier must ensure that his/her body and clothing touch only the inner surface of the coat.

**11.** Don the chemical-protective overboots.

**a.** Buddy: Open the package containing the new overboots, and have the Soldier remove the overboots, being careful not to touch the outside of the package.

**b.** Don the overboots over the combat boots. Adjust and secure the strap-and-buckle fasteners. Pull the trouser legs over the overboots, and secure the two hook-and-pile fastener tapes on each ankle to fit snugly around the overboot.

**12.** Don the chemical-protective hood.

**a.** Put the hood on. Close the front slide fastener on the coat completely, and secure the hook-and-pile fastener tape on the front flap as far as the top of the slide fastener.

**b.** Place the edge of the hood around the edge of the mask, and secure the hook-and-pile fastener tape on the hood.

### WARNING

To prevent the lock from unfastening and possibly exposing the user to contamination, the barrel lock release button must face away from the user when worn.

**c.** Pull the draw cord tight around the edge of the mask, snap the barrel locks together, squeeze both ends of the lock while pulling the draw cord, and slide the barrel lock up under the chin to keep the cord in place.

**d.** Buddy: Without touching the Soldier, inspect the hood and mask to ensure that the hood is positioned properly, the skin is not exposed, and any excessive draw cord is tied into a bow, .

## Performance Steps

- e. Adjust as directed.

**Note:** If buddy assistance is required for proper adjustment, the buddy decontaminates his/her gloves before touching the Soldier's hood or mask.

### 13. Don the chemical-protective gloves and liners.

- a. Buddy: Open the package containing the new chemical-protective gloves and liners. The Soldier removes the gloves and liners, being careful not to touch the outside of the package.

- b. Don the liners and gloves, pull the cuffs of the coat over the chemical-protective gloves, and fasten the hook-and-pile fasteners on each coat sleeve.

- c. Put on the M9 chemical-agent detection paper as required by the standing operating procedure (SOP).

### 14. Reverse roles with your buddy, and repeat steps 3 through 13.

### 15. Secure individual gear.

- a. Place a new chemical-protective helmet cover on the helmet, if a personnel armor system ground troop (PASGT) helmet is used.

- b. Use the buddy system to check the fit of the gear.

**Evaluation Preparation:** *Setup:* Provide the Soldier with the items listed in the task conditions statement. Evaluate this task during field exercises or normal training sessions. Soldiers must be in MOPP4.

*Brief Soldier:* Identify buddy pairs, designating the initial task performer and the buddy. Provide each Soldier with one of the following three scenarios: (1) The Soldier has been exposed to chemical or biological contamination (steps 2 and 4b are omitted), (2) The Soldier has been exposed to radiological contamination (steps 1 and 4a are omitted), or (3) The Soldier has been exposed to radiological and chemical and/or biological contamination (all steps must be performed).

Performance Measures	GO	NO GO
1. Decontaminated individual gear for chemical or biological contamination without assistance.	___	___
2. Decontaminated individual gear for radiological contamination without assistance.	___	___
3. Prepared for decontamination.	___	___
4. Decontaminated the mask and hood.	___	___
5. Doffed the chemical-protective coat.	___	___
6. Doffed the chemical-protective trousers.	___	___
7. Doffed the chemical-protective overboots.	___	___
8. Doffed the chemical-protective gloves and liners.	___	___

Performance Measures	GO	NO GO
9. Donned the chemical-protective trousers.	_____	_____
10. Donned the chemical-protective coat.	_____	_____
11. Donned the chemical-protective overboots.	_____	_____
12. Donned the chemical-protective hood.	_____	_____
13. Donned the chemical-protective gloves and liners.	_____	_____
14. Reversed roles with the buddy, and repeated steps 3 through 13.	_____	_____
15. Secured individual gear.	_____	_____

**Evaluation Guidance:** Refer to chapter 1, paragraph 1-9e, (1) and (2).

**References**

**Required:** FM 3-11.4

**Related:** FM 3-3, FM 3-5, FM 4-25.11, and FM 8-285

**SUBJECT AREA 4: SURVIVE (COMBAT TECHNIQUES)**

**052-192-1269**

**Detect Explosive-Hazard Indicators by Visual Means**

**Conditions:** You are given an area (urban or rural) to maneuver in, around, or through in support of a mission or operation containing explosive-hazard indicators.

**Standards:** Visually detect all explosive-hazard indicators in the prescribed area without causing injury to personnel or damage to equipment. Notify the immediate supervisor of any suspected indicators.

**Performance Steps**

**Note:** Explosive hazards consist of mines, booby traps, unexploded ordnance (UXO), and improvised explosive devices (IEDs). See task 093-401-5040 for information on identifying and taking immediate actions when dealing with UXO.

**WARNING**

IEDs and UXO are prevailing hazards in the contemporary operational environment. IEDs and UXO include ordnance items that have been fired, projected, dropped, or placed in such a way that they could become armed and functional. Whether in an area by design or accident or deliberately placed, these items have not yet functioned. Whatever the reason, IEDs or UXO pose the risk of injury or death to all personnel and damage or destruction to equipment in the immediate vicinity. Once recognized, do not approach an IED or UXO.

## Performance Steps

1. Gather information pertaining to explosive hazards that are associated with the area of operations. Get this information from—
  - a. Leader-disseminated information (operation orders and reports).
  - b. References (graphic training aids, land mine handbooks, and special publications).
  - c. Mine or ordnance recognition boards.
  - d. Intelligence briefings.
2. Recognize explosive-hazard indicators (environmental and deliberate).

**Note:** The only absolute indicators that an explosive hazard is present are if someone visually detects an explosive hazard, a person or vehicle detonates an explosive hazard, or someone witnesses a detonation. Spotting an explosive hazard as an initial indicator is extremely rare and should not be the primary focus of detecting these hazards.

### CAUTION

Always be alert for signs of anything out of place, unnatural, or suspicious when maneuvering in, around, or through an area. If a possible indicator is seen, stop, assess the indicator, and look for other indicators to confirm or deny the possible hazard before continuing or taking further action.

- a. Check for any environmental indicators. Look for—

**Note:** With the exception of stake mines and the majority of directional fragmentation mines, most hand or mechanically laid mines are buried. Burying mines disturbs the natural surface of the ground and nature will usually show where this event took place. Unusual erosion, plant growth, or animal casualties may be vital clues that there might be mines, booby traps, IEDs, or UXO present.

- (1) Animals (dead or alive) with missing or damaged limbs.

**Note:** Animals can walk several miles before collapsing. Dead animals along a route may also be an indicator of a concealed IED.

- (2) Human remains.
- (3) Damaged vehicles left on or off the road.
- (4) Wilted or dead patches of vegetation.
- (5) Circles of lush grass among thin grass.
- (6) Overgrown, unattended fields and pastures next to cultivated used areas.

(7) Trees and bushes not collected for firewood in areas stripped of other vegetation.

(8) Odd features in the ground or patterns that are not normally present in nature.

(9) Unattended vehicles, trailers, or boxes and abandoned military equipment (weapons, ammunition, uniforms, or papers).



## Performance Steps

### CAUTION

These indicators may represent an IED or booby trap. Be alert for wires, detonating cord, or a shock tube running from these devices to the roadside. Cables or wires used in command-detonated devices are sometimes buried. Look for disturbed soil in lines running up to the road and away from the suspected or suspicious areas.

(10) Ground that has been disturbed, to include—

- (a) Depressions in the ground (regular or odd spacing).
- (b) Raised patches of earth (regular or odd spacing).

(11) Unused paths, routes, or trails.

(12) Debris on or along a route that could conceal an IED or UXO.

(13) Suspicious guard rails and bridge overpasses. Be aware of suspected strike locations or suspicious personnel in the vicinity of these locations.

(14) Indications of road repair (new fill, pavement, patches, ditches, or culverts).

*Note:* There may be signs of single holes or several holes, possibly in some form of a pattern at tactical or key locations.

(15) Potholes in tracks.

(16) Disturbances in previous tire tracks or tracks that stop unexplainably.

(17) Single or multiple craters (look for submunitions).

(18) Unusual or suspicious civilian activity, to include—

(a) Areas avoided by local civilians (pedestrian or vehicular traffic).

(b) Absence of children in the area.

(c) Civilians with video cameras recording ordinary activities or military movements.

(19) Patterns of objects that could be used as a sighting line or concealing wire leads for IEDs.

(20) Mine, explosives, or ordnance crates or packaging.

(21) Patches of new brickwork, plaster, or mud on walls.

(22) Abandoned defensive positions, trenches, and destroyed buildings.

(23) Graffiti on walls or buildings in the local language.

(24) Signs being placed where they were not previously posted.

(25) Abandoned buildings, vehicles, piles of wood, or materials.

### CAUTION

Buildings are excellent sites for booby traps. Assume that all unoccupied buildings are booby-trapped.

(26) Trip wires, strings, or cables.

(27) Evidence of electrical wires, batteries, mousetraps, clothespins, steel tubes, or springs. If detected, additional hazards may be in the general area due to the setup of a deliberate chain reaction (daisy chain) or decoy.

## Performance Steps

(28) Small shiny metal plates, split lightweight bomb casings, empty cluster bomb canisters, and small parachutes or drogues (funnel-shaped drag chute) from submunitions (all indicators of cluster bomb strikes or scatterable mine attacks). If detected, additional items could be in the local area due to the dud rate of cluster bomb submunitions.

- b. Check for any deliberate indicators (improvised or manufactured).

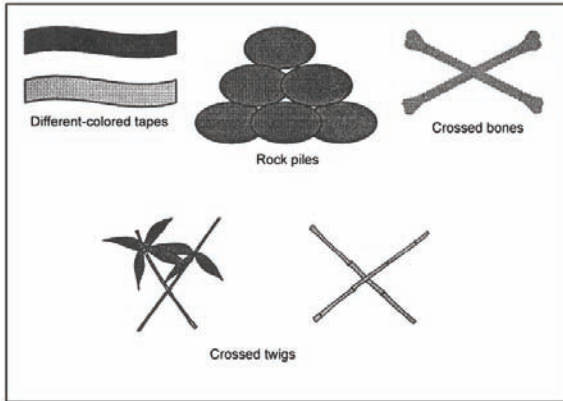

**Figure 052-192-1269-1. Examples of explosive-hazard markers**

**Note:** Not all armies and fighting organizations mark their minefields and other explosive hazards to the same standards as required by the United States (US) Army. Many local factions, militia, or units will lay mines and mark them in their own way with readily available materials rather than formal markings. These markings are generally used to warn their own troops and local civilians of the presence of mines, booby traps, IEDs, or UXO. Friendly units operating in these environments must gain this local knowledge in order to identify mine markers and explosive-hazard areas.

(1) Check for improvised markings of mines, booby traps, IEDs, and UXO (figure 052-192-1269-1). Look for—

(a) Rock piles or individual rocks painted red (used by the United Nations [UN], threat army, or fighting factions, and locals as danger area markers).

(b) Different-colored tapes attached to a stick, tree limb, picket, pole, or wall.

(c) Crossed bones, sticks, or twigs.

(d) Graffiti in the local language (a translator or an interpreter may be required) that warns civilians of a possible explosive hazard.

(e) Pieces of both cloth and metal material attached to poles, sticks, or walls.

**Note:** Step 2b(1)(a) through (e) are used by various fighting factions and locals to mark the minefield perimeters.

## Performance Steps

(f) A circle of stones surrounding objects (used by locals to mark individual mines, UXO, and IEDs).

(g) Rows of light-colored stones or stones that are painted white (used by the UN to mark safe lanes and cleared areas; stones are usually in regular patterns and close together).

(h) Red lettering and marks painted on rock faces or building walls.

**Note:** For example, start point (SP), indicating the minefield start point. Internationally recognized humanitarian demining reference markers, such as reference point (RP) and benchmark (BM). Minefields will be within visual distance of these markers.

(i) Burned fields (may indicate UN mine clearance operations).

(j) Wooden posts with red and white tops to delineate ongoing UN minefield clearance operations.

(2) Check for manufactured markings of mines, booby traps, IEDs, and UXO (figure 052-192-1269-2). Look for—

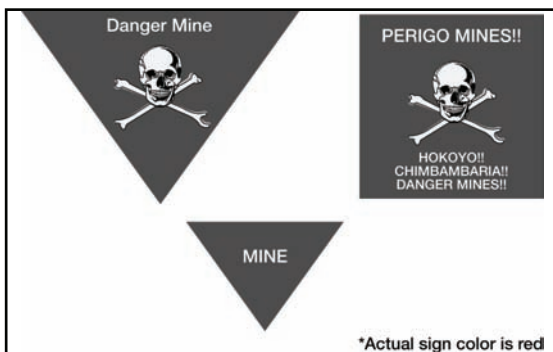

Figure 052-192-1269-2. Example of mine signs

(a) rectangular or triangular signs attached to wire, stakes, posts, or pickets with a written warning on one side.

(b) Signs with a picture of a person being blown up by a mine.

3. Notify the immediate supervisor of any suspected indicators.

**Evaluation Preparation:** *Setup:* Provide an area that contains suspected mine, booby trap, UXO, and IED indicators. Provide several types of indicators like those listed in step 2. Record and provide a description of all suspected explosive-hazard indicators and their locations on an evaluation sheet. Observe the Soldier's performance for improper identification that may cause him or her to miss an indicator within the designated lane.

*Brief Soldier:* Tell the Soldier to locate all explosive-hazard indicators within the designated lane.

Performance Measures	GO	NO GO
1. Gathered information pertaining to explosive hazards that were associated with the area of operations.	___	___
2. Recognized explosive-hazard indicators.	___	___
3. Notified the immediate supervisor of any suspected indicators.	___	___

**Evaluation Guidance:** Refer to chapter 1, paragraph 1-9e, (1) and (2).

**References**

**Required:**

**Related:** FM 20-32, GTA 05-10-044, GTA 09-12-001, and TC 20-32-5

## 071-000-0006

### React to Man-to-Man Contact

**Conditions:** Faced with an unarmed threatening adversary.

**Standards:** Maintain situational awareness; remain calm and gain control using combatives.

#### Performance Steps

**Note:** Soldiers must be prepared to use different levels of force in an environment where conflict may change from low to high intensity over a matter of hours. Many military operations, such as peace keeping missions (SASO) or noncombatant evacuations, may restrict the use of deadly weapons. Hand-to-hand combatives training will save lives when an unexpected confrontation occurs.

**Basic Principles.** Underlying all combative techniques are principles the hand-to-hand Soldier must apply to defeat an opponent. The natural progression of techniques, as presented in FM 3-25.150, will instill these principles into the Soldier.

**Note:** This task is only a basic introduction to combatives. For advanced combatives, refer to FM 3-25.150.

1. Maintain situational awareness; opportunity, weapons, and other personnel.
2. Remain calm; maintain advantage of the changing battlefield situation; maintain a base and dominant body position.
3. Use hand-to-hand techniques to gain and maintain the superior position.

a. **Back Mount.** Wrap both legs around the enemy with the heels "hooked" inside their legs. One arm is under an armpit and the other is around the neck and the hands are clasped (figure 071-000-0006-1).



**Figure 071-000-0006-1. Back mount**

*Note:* The back mount gives the Soldier the best control of the fight. From this position it is very difficult for the enemy to either defend themselves or counterattack. Even though a Soldier may find himself/herself with his/her own back on the ground, this is still the back mount and they still have control of the fight.

**b.** Front Mount. Knees are as high as possible toward the enemy's armpits. This position should be held loosely to allow the enemy to turn over if they should try (figure 071-000-0006-2).



**Figure 071-000-0006-2. Front mount**

## Performance Steps

**Note:** The front mount is a dominant position because it allows the Soldier to strike the enemy with punches without the danger of effective return punches. It also provides the leverage to attack the enemy's upper body with joint attacks.

c. Guard. It is important initially for the Soldier to lock his/her feet together behind the enemy's back to prevent them from simply pushing the Soldier's knees down and stepping over them (figure 071-000-0006-3).



**Figure 071-000-0006-3. Guard**

**Note:** If the Soldier must be on the bottom, the guard position allows the best defense and the only chance of offense.

d. Side Control. The Soldier should place his/her elbow on the ground in the notch created by the enemy's head and shoulder. His/her other hand should be palm down on the ground on the near side of the enemy. The leg closest to the enemy's head should be straight and the other one bent so that the knee is near the enemy's hip. The Soldier should keep his/her head down to avoid knee strikes (figure 071-000-0006-4).



**Figure 071-000-0006-4. Side control**

## Performance Steps

**Note:** Although the side control is not a dominant position, many times the Soldier will find himself/herself in this position, and he/she must be able to counter the enemy's defensive techniques.

**Distance.** Each technique has a window of effectiveness based upon the amount of space between the two combatants. The Soldier must control the distance between himself/herself and the enemy in order to control the fight.

**Physical Balance.** Balance refers to the ability to maintain equilibrium and to remain in a stable, upright position.

**Leverage.** A Soldier uses the parts of his/her body to create a natural mechanical advantage over the parts of the enemy's body. By using leverage, a Soldier can have a greater effect on a much larger enemy.

**Evaluation Preparation:** If using a sawdust pit, inspect all sandbags on the retaining wall before conducting training to ensure that the bags are serviceable, at least 75 percent are full, and the entire retaining wall is covered with sandbags. Any bag placed where personnel are likely to fall will be filled with the same consistency filler as the sawdust in the pit and will provide a minimum of 6 inches of sawdust.

Maintain a buffer zone 6 feet from the retainer wall and demonstration area during all training, especially training requiring throws and takedowns by Soldiers.

Rake the training pit to loosen sawdust and remove all sharp objects. Properly inspect the pit so all safety hazards are removed prior to instruction or demonstrations are executed.

Perform inspections of the depth of the sawdust with enough time before training to resurface the pit. Remember to rake and inspect new sawdust for foreign objects that may cause injuries.

Performance Measures	GO	NO GO
1. Maintained situational awareness.	___	___
2. Remained calm.	___	___
3. Demonstrated hand-to-hand techniques.	___	___
4. Maintained superior position and demonstrated the follow techniques:	___	___
a. Back mount.	___	___
b. Front mount.	___	___
c. Guard.	___	___
d. Side control.	___	___

Evaluation Guidance: Refer to chapter 1, paragraph 1-9e, (1) and (2).

### References

**Required:** FM 3-25.150

**Related:**

# 071-326-0502

## Move Under Direct Fire

**Conditions:** As a member of a two-man team, given a tactical situation where you must approach an enemy position from a distance of 250 to 300 meters across varied terrain; an M16A1 rifle or M203 grenade launcher; load-carrying equipment (LCE).

**Standards:** Move within 100 meters of the enemy position. Use the correct individual tactical fire and movement techniques dictated by terrain features. Coordinate movement with team members and provide covering fire for each member.

### Performance Steps

1. Select an individual movement route within your team, or squad route or axis of advance (figure 071-326-0502-1).

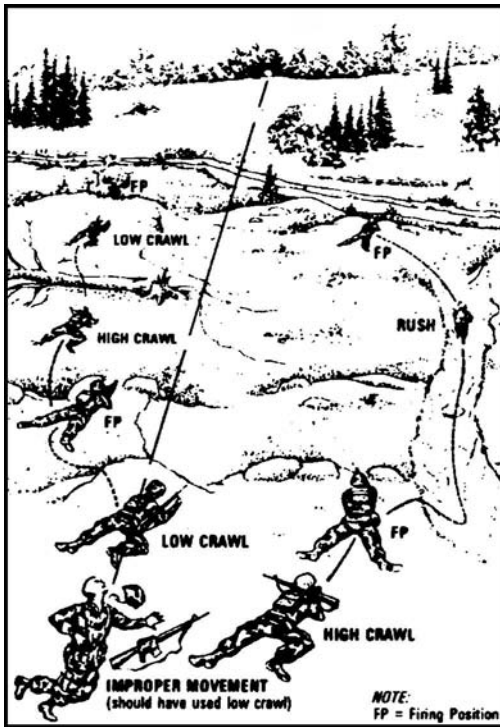

Figure 071-326-0502-1. Individual movement route

- a. Search the terrain to your front for—

- (1) A gully, ravine, ditch, or wall at a slight angle to your direction of movement.

*Note:* These features provide cover and concealment when using the low or high crawl.

- (2) Hedgerows or a line of thick vegetation.

*Note:* These features provide concealment only during the low or high crawl.



## Performance Steps

(3) Large trees, rocks, stumps, fallen timber, rubble, vehicle hulks, folds, or creases in the ground.

*Note:* These features provide cover and concealment for use as temporary positions. Use the rush if the area between them has no concealment.

(4) High grass or weeds.

*Note:* These features provide only partial concealment. You can use the rush because using the high or low crawl could move vegetation and reveal your location.

- b. Select your next position (and the route to it) as the one that—
    - (1) Exposes you to the least enemy fire.
    - (2) Does not require you to cross in front of other members of your element, masking their fires.
  2. Determine the correct individual movement technique.
    - a. Select the high crawl when—
      - (1) The route provides cover and concealment.
      - (2) Poor visibility reduces enemy observation.
      - (3) Speed is required, but the terrain and vegetation are suitable only for the low crawl.
    - b. Select the low crawl when—
      - (1) The route provides cover or concealment less than 1 foot high.
      - (2) Visibility provides the enemy with good observation.
      - (3) Speed is not required.
    - c. Select the rush when—
      - (1) You must cross open areas.
      - (2) Time is critical.
  3. Communicate the movement plan to your buddy or team leader using hand signals so that the Soldier not moving can cover by fire the other Soldier's movement, if any.

*Note:* When moving as a member of a fire team, watch and listen to your team leader who will lead you along the best route available and ensure that covering fire is provided when you move. Stay with your team leader and follow his/her example.
  4. Use the high crawl (figure 071-326-0502-2).
-



Figure 071-326-0502-2. High crawl

- a. Keep your body off of the ground
  - b. Rest your weight on your forearms and lower legs.
  - c. Cradle your weapon in your arms, keeping its muzzle off the ground.
  - d. Keep your knees well behind your buttocks, so your buttocks stays low.
  - e. Move forward by alternately advancing your right elbow and left knee, then your left elbow and right knee.
5. Use the low crawl (figure 071-326-0502-3).

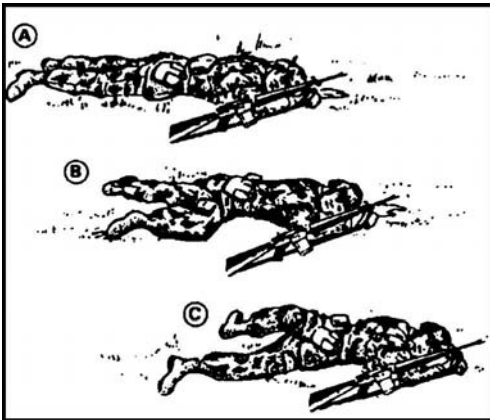

Figure 071-326-0502-3. Low crawl

- a. Keep your body as flat as possible to the ground.
- b. Hold your weapon by grasping the sling at the upper sling swivel and letting the handguard rest on your forearm. Let the butt of the weapon drag on the ground. This will help you keep the muzzle off the ground.

## Performance Steps

- c. Move forward by—
  - (1) Pushing both arms forward while pulling your right leg forward.
  - (2) Pulling with both arms while pushing with your right leg.
  - (3) Continuing this push-pull movement until you reach your next position, changing your pushing leg frequently to avoid fatigue.
6. When enemy fire allows brief exposure, use the rush to move from one covered position to another (figure 071-326-0502-4).

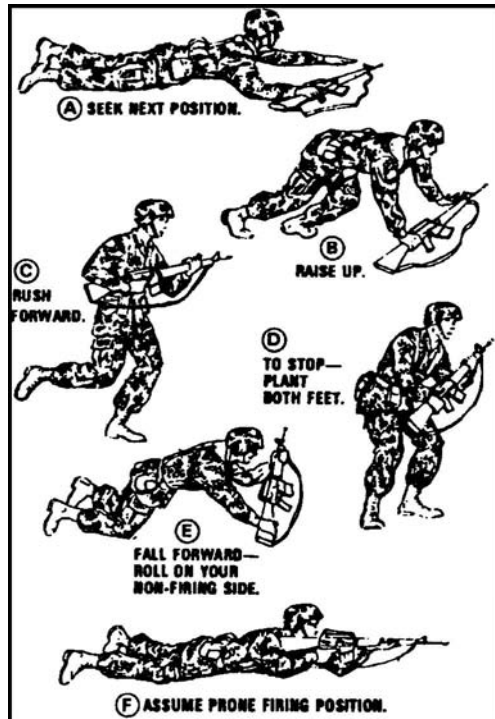

Figure 071-326-0502-4. Rush

- a. Move from your firing position by rolling or crawling.
- b. Start from the prone position.
- c. Slowly raise your head and select your next position.
- d. Lower your head while at the same time drawing your arms into your body, elbows down, and pulling your right leg forward.
- e. Raise your body in one movement by straightening your arms.
- f. Spring to your feet, stepping off with either foot.

## Performance Steps

- g. Run to the next position—
    - (1) Keep the distance short to avoid accurate enemy fire.
    - (2) Try not to stay up any longer than 3 to 5 seconds so that the enemy does not have time to track you with automatic fire.
  - h. Plant both feet just before hitting the ground.
  - i. Fall forward by—
    - (1) Sliding your right hand down to the heel of the butt of your weapon.
    - (2) Breaking your fall with the butt of your weapon.
  - j. Assume a firing position.
    - (1) Roll on your side.
    - (2) Place the butt of your weapon in the hollow of your shoulder.
    - (3) Roll or crawl to a covered or concealed firing position.
7. Cover your buddy's movement with fire.

**Evaluation Preparation:** *Setup:* Take Soldiers on a simulated march or field exercise in battle dress with LCE and weapons. Select an area with varying cover types and heights. Select a site about 300 meters away to serve as an enemy position. Point out the site to the Soldiers. Pair up Soldiers being tested.

*Brief Soldier:* Tell the Soldiers to pretend they are under direct fire. Tell them to move from their present position to within 100 meters of the enemy position and use the buddy system. Tell the Soldiers to use the appropriate movement technique in performance measures 4, 5, and 6, as appropriate for the scenario and terrain. It may not be appropriate for each Soldier to use all three techniques.

Performance Measures	GO	NO GO
1. Selected an individual movement route within your team, or squad route, or axis of advance.	___	___
2. Determined the correct individual movement technique.	___	___
3. Communicated the movement plan to your buddy or team leader using hand signals, so that the Soldier not moving could cover by fire the other Soldier's movement, if any.	___	___
4. Used the high crawl.	___	___
5. Used the low crawl.	___	___
6. Used the rush to move from one covered position to another.	___	___
7. Covered your buddy's movement with fire.	___	___

**Evaluation Guidance:** Refer to chapter 1, paragraph 1-9e, (1) and (2).

**References**

**Required:** FM 21-75

**Related:**

---

## **071-326-0503**

### **Move Over, Through, or Around Obstacles (Except Minefields)**

**Conditions:** Given an individual weapon, load-carrying equipment (LCE), one smoke grenade, wood or grass mats or chicken wire, a grappling hook, wrapping material, wire cutters (optional); a buddy, in daylight or darkness, at a field location; and a route with both natural and manmade crossings and obstacles (walls and barbed wire entanglements).

**Standards:** Approach over a specified route to within 100 meters of a suspected enemy position. Negotiate each obstacle that you encounter within the designated time. Retain all your equipment. Avoid becoming a casualty to a booby trap or early warning device.

---

#### **Performance Steps**

1. Cover your advance with smoke when crossing an obstacle.
2. Ensure your buddy is covering you since obstacles are normally protected by either fire or observation.
3. Cross barbed wire obstacles.

#### **WARNING**

The enemy routinely attaches trip-wire-activated mines to barbed wire.

- a. Check barbed wire for booby traps or early warning devices.
  - (1) Look for booby traps or early warning devices attached to the barbed wire.
  - (2) Throw a grappling hook with a length of rope attached over the barbed wire.
  - (3) Pull the rope to set off any booby traps or early warning devices.
- b. Cross over barbed wire using wood, grass mats, or chicken wire to protect you from the barbs.
  - (1) Throw the wood, mat, or chicken wire over the barbed wire.
  - (2) Cross carefully because such a mat or net forms an unstable path.
- c. Cross under barbed wire.
  - (1) Slide head first on your back under the bottom strands.
  - (2) Push yourself forward with your shoulders and heels, carrying your weapon lengthwise on your body and holding the barbed wire with one hand while moving.
  - (3) Let the barbed wire slide on the weapon to keep the barbed wire from catching on your clothing and equipment.
- d. Cut your way through barbed wire.

## Performance Steps

- (1) Leave the top wire in place to reduce the chance that the enemy will discover the gap.
  - (2) Wrap cloth around the barbed wire between your hands.
  - (3) Cut partly through the barbed wire.
  - (4) Bend the barbed wire back and forth quietly until it separates.
  - (5) Cut only the lower strands.
4. Cross exposed danger areas such as roads, trails, or small streams.
    - a. Select a point at or near a bend in the road or stream. If possible, select a bend that has cover and concealment on both sides.
    - b. Crawl up to the edge of the open area.
    - c. Observe the other side carefully before crossing.
    - d. Move rapidly but quietly across the exposed area.
    - e. Take cover on the other side.
    - f. Check the area around you.
  5. Cross over a wall.
    - a. Roll quickly over the top.
    - b. Do not go over standing upright.
  6. Cover your buddy as he/she crosses the obstacle.

**Evaluation Preparation:** *Setup:* Select a good field location with crossings, walls, and barbed wire entanglements. Designate a suspected opposing force position and point this out to the Soldiers. Time yourself and an assistant as you run the course twice. Average your times and add 10 percent to determine the maximum time the Soldiers will have to run the same course.

*Brief Soldiers:* Tell Soldiers that you will evaluate how they move over, through, and around the obstacles while they try to get within 100 meters of an enemy position. Tell them that they must negotiate at least one of each type of obstacle: an exposed danger area, barbed wire, and a wall. Tell them they must run the course within the time you computed while setting up the site.

Performance Measures	GO	NO GO
1. Covered your advance with smoke when crossing an obstacle.	___	___
2. Ensured your buddy was covering you since obstacles are normally protected by either fire or observation.	___	___
3. Crossed barbed wire obstacles.	___	___
4. Crossed exposed danger areas such as roads, trails, or small streams.	___	___
5. Crossed over a wall.	___	___

Performance Measures	GO	NO GO
6. Covered your buddy while crossing the obstacle.	___	___

**Evaluation Guidance:** Refer to chapter 1, paragraph 1-9e, (1) and (2).

**References**

**Required:** FM 21-75

**Related:**

## 071-326-0510

### React to Indirect Fire While Dismounted

**Conditions:** You are a member (without leadership responsibilities) of a squad or team. You are either in a defensive position or moving on foot. You hear incoming rounds, shells exploding or passing overhead, or someone shouting "incoming."

**Standards:** React to each situation by shouting "Incoming!" Follow the leader's directions, if available, and then either take new or maintain existing cover.

#### Performance Steps

1. Shout "Incoming!" in a loud, easily recognizable voice.
2. Look to your leader for additional instructions.
3. Remain in your defensive position (if appropriate), and make no unnecessary movements that could alert the enemy to your location.
4. Take cover outside the impact area (if you are in an exposed position or moving). Keep your body low if the leader is not in sight.

**Evaluation Preparation:** *Setup:* Take the Soldiers on a simulated march or field exercise.

*Brief Soldiers:* Tell the Soldiers that they must react to indirect fire on the move and when in a fixed position after hearing the command "Incoming!"

Performance Measures	GO	NO GO
1. Shouted "incoming" in a loud, easily recognizable voice.	___	___
2. Looked to the leader for additional instructions.	___	___
3. Remained in the defensive position (if appropriate), and made no unnecessary movements that could have alerted the enemy to your location.	___	___
4. Took cover outside of the impact area (if you were in an exposed position or moving); and, if your leader was out of sight, kept your body low.	___	___

**Evaluation Guidance:** Refer to chapter 1, paragraph 1-9e, (1) and (2).

**References**

**Required:** FM 21-75

**Related:**

---

# 071-326-0511

## React to Flares

**Conditions:** Given a tactical situation at night, the sound of a flare rising, or sudden illumination from a ground or overhead flare.

**Standards:** React to a ground or an overhead flare without being seen by the enemy or losing your night vision.

---

### Performance Steps

---

1. Respond to ground flares.
  - a. Move from the illuminated area.
  - b. Reorient yourself when alone or in a group according to standing operating procedures (SOPs) or as instructed.
  - c. Continue the mission.
2. Respond to an overhead flare with warning such as the sound of a rising flare.
  - a. Assume the prone position, behind concealment when available, before the flare bursts.
  - b. Protect your night vision by closing one eye and observing with the other.
  - c. Switch and use the night vision-protected eye to reorient yourself or rejoin your group when the flare burns out.
  - d. Continue the mission.
3. Respond to an overhead flare without warning.
  - a. Assume the prone position behind concealment (when available) until the flare burns out.
  - b. Protect your night vision by closing one eye and observing with the other.
  - c. When you must cross a wire obstacle where the prone position is not possible, crouch low until the flare burns out before crossing.
  - d. Switch eyes and use the night vision-protected eye to reorient yourself or rejoin your group when the flare burns out.
  - e. Continue the mission.

---

**Evaluation Preparation:** *Setup:* Have ground flares set so that you can ignite them when you are ready. Have hand-held flares to use to simulate the overhead flares.

*Brief Soldier:* Tell the Soldier to react to the flares as they appear. After grading the Soldier on his/her reaction to the ground flare and the overhead flare with warning, tell the Soldier that he/she should react to the next flare only after the flare has burst (simulate "without warning").



Performance Measures	GO	NO GO
1. Responded to a ground flare.	___	___
2. Responded to an overhead flare with warning.	___	___
3. Responded to an overhead flare without warning.	___	___

**Evaluation Guidance:** Refer to chapter 1, paragraph 1-9e, (1) and (2).

**References**

**Required:** FM 21-75

**Related:**

## 071-326-0513

### Select Temporary Fighting Positions

**Conditions:** Given a tentative defensive position, at a halt during movement or upon receiving direct fire.

**Standards:** Select a firing position that protects you from enemy observation and fire, and that allows you to place effective fire on enemy positions without exposing most of your head and body.

**Performance Steps**

1. Choose a position that takes advantage of available cover and concealment (figure 071-326-0513-1).

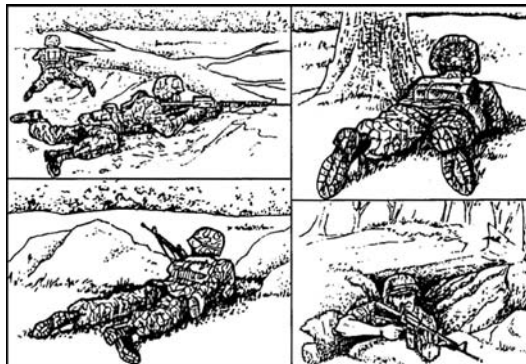

**Figure 071-326-0513-1. Temporary fighting positions**

**Note:** Cover protects you from bullets, fragments of exploding rounds, flame, nuclear effects, and biological and chemical agents. Cover can also conceal you from enemy observation. Cover can be natural or man-made. Concealment hides you from enemy observation. Concealment does not protect you from enemy fire. Never make the mistake of thinking that concealment can protect you from enemy fire. Concealment, like cover, can also be natural or manmade.

2. Choose a position that allows you to observe and fire around the side of an object while concealing most of your head and body.

## Performance Steps

3. Choose a position that allows you to stay low when observing and firing, whenever possible.

*Note:* This position allows you to aim better and take advantage of concealing vegetation.

4. Choose a position with a background that does not silhouette you against the surrounding environment.

*Note:* A position like this reduces your chances of being detected.

5. Follow your leader's directions after your initial selection of a temporary battlefield position.

*Note:* Your leader may reposition you to gain better coverage of the area.

**Evaluation Preparation:** *Setup:* Evaluate this task during a march or a simulated march, in an area with varying degrees of cover and concealment. Have the Soldier wear full battle gear.

*Brief Soldier:* Tell the Soldier that the enemy has been reported in the area, and that he/she (the Soldier) might encounter the enemy at any time. At preselected points during the march, at a rest halt, after ordering the Soldier to take an overwatch position, or after ordering the Soldier to take a tentative defensive position, have the Soldier select a temporary fighting position.

Performance Measures	GO	NO GO
1. Chose a position that used available cover and concealment.	___	___
2. Chose a position that allowed observation and fire around the side of an object while concealing most of your head and body.	___	___
3. Chose a position that allowed you to stay low when observing and firing, whenever possible.	___	___
4. Chose a position with a background that prevented you from silhouetting yourself against your surroundings.	___	___
5. Followed your leader's directions after the initial selection of a temporary battlefield position.	___	___

**Evaluation Guidance:** Refer to chapter 1, paragraph 1-9e, (1) and (2).

## References

**Required:** FM 21-75

**Related:**

---

## 071-326-0541

### Perform Movement Techniques During an Urban Operation

**Conditions:** As a member of an assault element in urban terrain, with the enemy's location and strength uncertain, given an individual weapon with ammunition, and load-bearing equipment.

**Standards:** Perform a visual reconnaissance to determine the next position; use proper movement techniques; and move rapidly to the next covered or concealed position with minimum exposure to enemy fire.

---

#### Performance Steps

**Note:** The individual, fire team, and squad movement techniques within urban terrain differ slightly from the basic movements used in normal field operations. Several movement techniques take on added importance during combat in urban terrain due to the nature of the battle area.

**Note:** In urban terrain, the individual Soldier and leaders are confronted with different types of obstacles that they must negotiate to eliminate or capture an enemy position. Street-to-street and house-to-house fighting give rise to many surprising situations, so alertness and all-round security are mandatory. The enemy might appear not only from the front, flanks, and rear, but also from above and below.

1. Follow the general rules of movement:
  - a. Take care to avoid silhouetting yourself in doors or windows, or on rooftops.
  - b. Avoid open areas (streets, alleys, and parks).
  - c. Make a visual reconnaissance of the next position before moving.
  - d. Conceal movement with smoke or covering fires and by using buildings, rubble, and vegetation.
  - e. Always move rapidly from one position to another.
  - f. Stay alert and expect the unexpected.
2. Observe around corners.

**Note:** Corners are hazardous to untrained Soldiers who fail to remain alert. The most common three mistakes untrained Soldiers make are—

- Failing to recognize the danger area.
  - Extending their weapons beyond the corner, exposing their presence.
  - Showing their heads at a height that enemy soldiers would expect to see them.
    - a. Lie flat on the ground, weapon at your side, then move forward slowly, ensuring that your weapon is not forward of the corner.
-

## Performance Steps

- b. Expose your head slowly at ground level so that it appears to be a shadow. Expose your head only enough to observe around the corner (figure 071-326-0541-1).

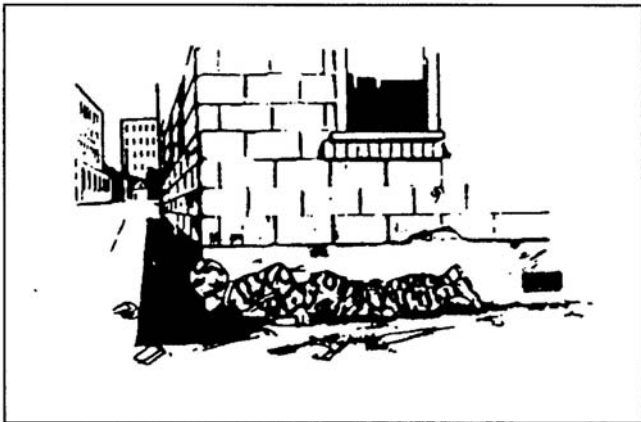

**Figure 071-326-0541-1. Observing around a corner**

3. Move across open areas. Avoid these areas (such as streets, alleys, and parks) when possible because they are natural kill zones for enemy crew-served weapons. If you must cross an open area, reduce your risk by taking the following basic precautions:

- a. Make a visual reconnaissance of the area and position.
              - b. Select a route that has some cover or concealment. If none is available, use smoke or covering fire provided by the rest of the element.
              - c. Move by the most direct route to the selected position to reduce the time of exposure to enemy fire. Also, moving rapidly denies the enemy the chance to place well aimed shots.
              - d. Move from position to position without masking covering fires. When you reach your next position, be ready to cover the movement of other members of your fire team or squad (figure 071-326-0541-2).



Figure 071-326-0541-2. Moving from cover to cover

e. Move two or more Soldiers. When two or more Soldiers must move at the same time to another position—

(1) The group must prepare to position themselves to move to the next position.

(2) On a planned signal, the group moves across the open area to the next position at the same time. They move about 5 meters apart (figure 071-326-0541-3).



Figure 071-326-0541-3. Group moving to the next position

4. Move parallel to buildings.

## Performance Steps

a. Move along the wall as closely as possible to deny an enemy soldier inside the building the chance to fire at you.

(1) Use all available cover and concealment, move with a low silhouette, and advance rapidly from position to position. If you have smoke, use it.

(2) When possible, move into the shadows, which will help conceal your movement.

b. Move past the first floor windows.

**Note:** Windows are danger points. Most first-floor windows are head high, and an unsuspecting Soldier will expose his/her head, giving the enemy an excellent shot from cover.

(1) The right way to pass first floor windows is to stay as close to the building as possible then, when you reach the window, duck your head well below it.

(2) Always take care to avoid silhouetting yourself in a window (figure 071-326-0541-4).



Figure 071-326-0541-4. Movement past window

c. Move past basement windows.

(1) Never just walk or run past a basement window. Your legs will present a good target to an enemy gunner inside the building.

(2) The right way to pass a basement window is to keep as close to the building as possible and, when you reach the window, step or jump above and across the window without exposing your legs (figure 071-326-0541-5 and figure 071-326-0541-6).

---

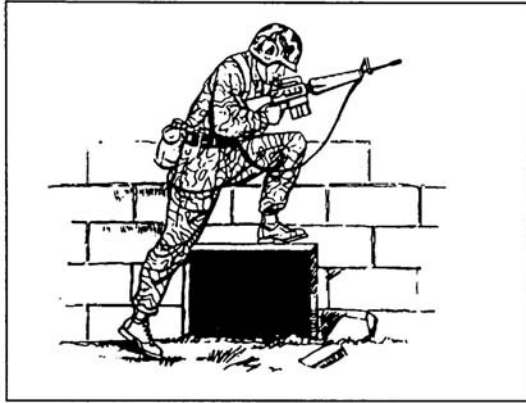

Figure 071-326-0541-5. Start of movement past basement window

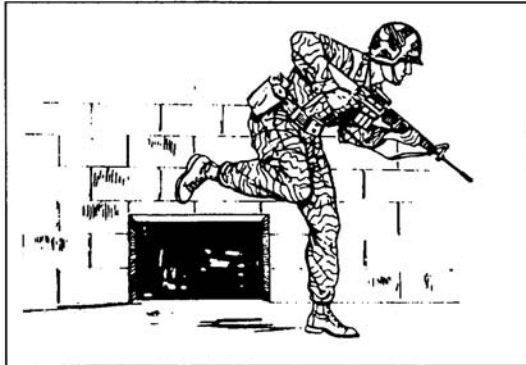

Figure 071-326-0541-6. Completion of movement past basement

5. Cross obstacles (walls, fences, and rooftops).

a. Move over walls and fences.

(1) Before crossing a wall or fence, look at and beyond it for booby traps, enemy positions, and covered or concealed positions.

(2) Move rapidly to the obstacle and roll quickly over it, keeping the lowest silhouette possible. Speed and a low silhouette deny the enemy a well aimed shot.

(3) Move rapidly to the nearest position while maintaining a low silhouette, with your weapon at the ready position (figure 071-326-0541-7).

---



Figure 071-326-0541-7. Crossing of an obstacle

b. Move over rooftops.

(1) Make a visual reconnaissance of the area and of the route to the next position.

(2) Move rapidly across the area, maintaining a low silhouette and using all available cover and concealment.

**Evaluation Preparation:** *Setup:* At the test site, provide all materials and equipment given in the task condition statement.

*Brief Soldier:* Tell the Soldier he/she will be moving as a designated member of an assault element in urban terrain. The enemy strength and location are unknown.

Performance Measures	GO	NO GO
1. Followed the general rules of movement.	___	___
2. Observed around corners.	___	___
3. Moved across open areas.	___	___
4. Moved parallel to the buildings.	___	___
5. Crossed obstacles.	___	___

**Evaluation Guidance:** Refer to chapter 1, paragraph 1-9e, (1) and (2).

**References**

**Required:**

**Related:** FM 3-06 and FM 3-06.11

**071-326-0542**

**Enter a Building During an Urban Operation**

**Conditions:** As a member of an assault force in an urban area, given a two-story building; a grapple hook attached to 50 feet of scaling rope knotted every foot; individual weapon and equipment; and hand grenades.

**Standards:** Enter and clear the building with minimal exposure to enemy fire.



## Performance Steps

1. Before moving, select a point to enter a building. There are several ways to enter a building above the first floor. Ladders, drainpipes, vines, helicopters, or roofs and windows of an adjoining building might help you reach the top floor or roof of a building. In some cases, one member of the assault force can climb onto the shoulders of another and reach high enough to pull himself up. A scaling rope and grappling hook can help you scale the wall or swing from one building to another to gain entrance through an upper story window or opening in the building.

2. Prepare a grappling hook with a rope to enter a building.

*Note:* The grappling hook is easily thrown and is made with hooks strong enough to hold a Soldier and all equipment. The scaling rope attached to the grappling hook should be long enough to reach the entrance point and knotted about every foot. The knots will help the Soldier climb.

a. When throwing the grappling hook, stand as close to the building as possible. (This reduces exposure to enemy fire and reduces the throwing distance to the target.) Grasp a few coils of rope and the grappling hook in your throwing hand and the rest of the rope in your nonthrowing hand. The throw should be a gentle, even, upward lob of the hook and coiled rope from the throwing hand (figure 071-326-0542-1). Your nonthrowing hand should release the rope, allowing it to play out.

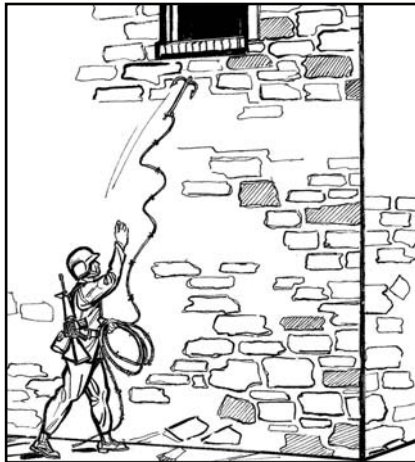

Figure 071-326-0542-1. Throwing the grappling hook

b. Once the grappling hook is inside the target area (or on the roof), pull on the rope until the hook catches solidly before you start the climb (figure 071-326-0542-2).

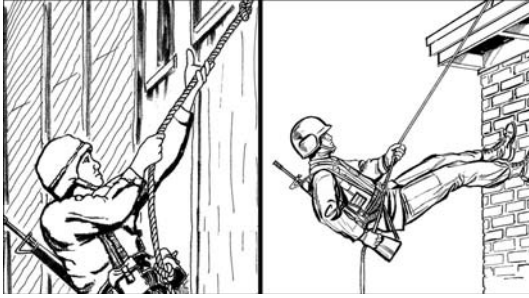

Figure 071-326-0542-2. Climbing

c. When climbing, avoid crossing windows of uncleared rooms. When you must pass such a window, throw a hand grenade into it through the window. Loosen the safety pins on all hand grenades to be used, but not to the point that they will fall out.

d. Once you reach the point of entry, throw in a hand grenade. Then, enter with the lowest silhouette possible. You can use either of two methods of entry. The preferred method is to hook a leg over a window sill and enter sideways, straddling the ledge (figure 071-326-0542-3). The other method is to enter head first (figure 071-326-0542-4).



Figure 071-326-0542-3. Straddling entry



Figure 071-326-0542-4. Headfirst entry

3. Use the buddy system to enter a building.
  - a. One-Soldier lift support. The first Soldier braces his/her back or side against the building. He/she then cups his/her hands together to assist the second Soldier.
    - (1) The second Soldier moves forward and places his/her foot inside of the first Soldier's cupped hands.
    - (2) The first Soldier then lifts the second Soldier up to the opening.
    - (3) Once the first Soldier reaches the point of entry, he/she enters, keeping the lowest silhouette possible (figure 071-326-0542-4).

- b. Two-Soldier lift support.
  - (1) Two Soldiers face each other, holding a support such as a board or tree limb (figure 071-326-0542-5).



Figure 071-326-0542-5. Two-man lift support position

- (2) A third Soldier climbs onto the support.

## Performance Steps

(3) Once both of the climber's feet are on the support, the two base Soldiers raise the support, pushing the third Soldier upward and into the entrance (figure 071-326-0542-6).

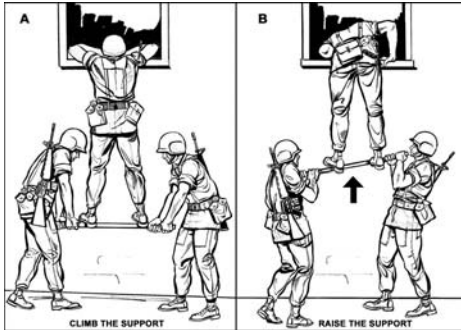

Figure 071-326-0542-6. Two-man lift support

### c. Two-Soldier hand lift.

(1) The climber stands facing the wall, with palms flat against the building, his/her feet out from the building about 2 feet, with the heels raised.

(2) Two Soldiers, one on each side of the climber, face each other and bend forward, cupping their hands.

(3) The two Soldiers with cupped hands each grasp a heel of the climber. With a quick move, they lift the climber up and into the entrance (figure 071-326-0542-7).

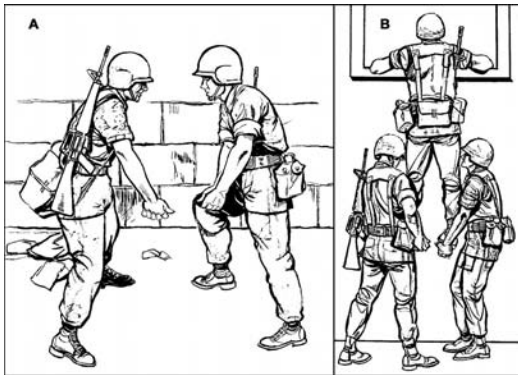

Figure 071-326-0542-7. Two-man hand lift

### 4. Select use of hand grenades.

a. Before entering a building, whether through a doorway, window, or breach, throw a hand grenade inside to disable enemy occupants and to detonate booby traps.

## Performance Steps

(1) When there is a breach in the exterior walls and when you plan to use this breach to enter the building, throw a hand grenade in using all available cover. Before you throw it, let it cook off for about 2 seconds (figure 071-326-0542-8).



**Figure 071-326-0542-8. Throwing the grenade through an opening**

(2) When entering through a window, use caution when throwing in the hand grenade; be sure that it goes through the opening and does not bounce back toward you. Before throwing the hand grenade, pull the safety. Let the grenade cook off for about 2 seconds, and then move out far enough to throw the grenade inside (figure 071-326-0542-9).



**Figure 071-326-0542-9. Throwing a grenade through a window**

### Performance Steps

(3) The least desirable method of entering a building is through a doorway. The enemy will expect you to enter this way. Before entering a door, check for booby traps. Then, allow a hand grenade to cook off for about 2 seconds, and then throw it inside.

5. Clear the entry point. Upon entering the building, the first member of the assault team must secure the room or area of entry while the rest of the team enters. The team then clears and secures the building.

**Evaluation Preparation:** *Setup:* At the test site, provide the Soldier with the equipment and materials listed in the task condition statement.

*Brief Soldier:* Tell the Soldier to enter and secure a building and clear out all enemy soldiers.

Performance Measures	GO	NO GO
1. Selected a point to enter a building prior to moving.	_____	_____
2. Prepared a grappling hook with a rope to enter a building.	_____	_____
3. Used the buddy system to enter a building.	_____	_____
4. Selected use of hand grenade.	_____	_____
5. Cleared the entry point.	_____	_____

**Evaluation Guidance:** Refer to chapter 1, paragraph 1-9e, (1) and (2).

### References

**Required:**

**Related:** FM 3-06

## 071-326-3002

### React to Indirect Fire While Mounted

**Conditions:** In a combat environment, given a combat-loaded tracked vehicle.

**Standards:** React to indirect fire by moving the vehicle from the impact area, and then continue the mission.

### Performance Steps

1. Give an order to close all hatches.
2. Direct movement away from the impact area.
3. Analyze the situation.
4. Give a situation report.
5. Continue the mission.

**Evaluation Preparation:** *Setup:* At the test site, provide a combat-loaded tracked vehicle. Use only dummy ammunition for training purposes. Take Soldiers on a simulated march.

*Brief Soldier:* Tell the Soldier that he/she must react to a simulated indirect-fire mortar or artillery fire while mounted in a tracked vehicle.

Performance Measures	GO	NO GO
1. Gave an order to close all hatches.	___	___
2. Directed movement away from the impact area.	___	___
3. Analyzed the situation.	___	___
4. Gave a situation report.	___	___
5. Continued the mission.	___	___

**Evaluation Guidance:** Refer to chapter 1, paragraph 1-9e, (1) and (2).

### References

**Required:**

**Related:** FM 3-21.71 and FM 7-7

## 071-410-0002

### React to Direct Fire While Mounted

**Conditions:** In a combat environment, given a tracked vehicle and a requirement to react to direct fire.

**Standards:** After analyzing the situation based on an order received from the chain of command, return vehicle fire and take appropriate action.

#### Performance Steps

**Note:** If the vehicle is in formation, move it according to the company tactical standing operating procedure (SOP). If not, use evasive action as appropriate to avoid threat fire while performing step 2.

1. Direct return fire to destroy or suppress threat fire.

**Note:** If the threat is destroyed, continue the present mission.

2. Direct the driver to a hull down position.

**Note:** Direct dismount, if appropriate, to establish a base of fire.

3. Analyze the situation.
4. Give a situation report.
5. Take defensive or offensive action based on orders from the chain of command.

**Evaluation Preparation:** *Setup:* At the test site, provide a tracked vehicle and all equipment and materials listed in the task condition statement. Use only blank ammunition for training. Take the Soldiers on a simulated march.

*Brief Soldier:* Tell the Soldiers to simulate direct fire while mounted in a tracked vehicle.

Performance Measures	GO	NO GO
1. Directed return fire to destroy or suppress threat fire.	___	___
2. Directed the driver to a hull-down position.	___	___
3. Analyzed the situation.	___	___
4. Gave a situation report.	___	___
5. Took defensive or offensive action based on orders from the chain-of-command.	___	___

**Evaluation Guidance:** Refer to chapter 1, paragraph 1-9e, (1) and (2).

**References**

**Required:**

**Related:** FM 3-21.71 and FM 7-7

## 093-401-5040

### React to Unexploded Ordnance Hazards

**Conditions:** In a field environment, given an item(s) of simulated unexploded ordnance (UXO), marking materials, and a 9-line Explosive Hazard Spot Report (formally the UXO Spot Report).

**Standards:** Identify the UXO by type and subgroup; recognize associated hazards; take immediate action to prevent death, injury, or damage to materiel; and report the UXO hazard using the 9-line Explosive Hazard Spot Report (formally the UXO Spot Report).

**Performance Steps**

1. Recognize the UXO hazard.

**DANGER**

**Never approach any closer to a UXO once it has been identified. Approaching UXOs may cause it to explode.**

**Never strike, jar, or touch a UXO. Do not move or remove anything on or near a suspected UXO. UXOs can be extremely sensitive and can cause serious injury or death if disturbed in any way.**

**Many types of UXO may contain an incendiary (fire producing), chemical, biological, or radiological hazard in addition to explosives.**

**Do not make radio transmissions within 100 meters of a UXO. Some types of UXO are sensitive to electromagnetic radiation (EMR) and may explode.**

- a. Identify the four types and subgroups of UXO.



## Performance Steps

### (I) Dropped.

#### (a) Bombs (see figure 093-401-5040-1).

- Vary in length from 3 to 6 feet.
- Vary in diameter from 5 to 36 inches.
- Often have a sloped or "bullet" shaped nose, fins, and/or a parachute on the back.
- May contain high explosive, incendiary, or chemical fillers.

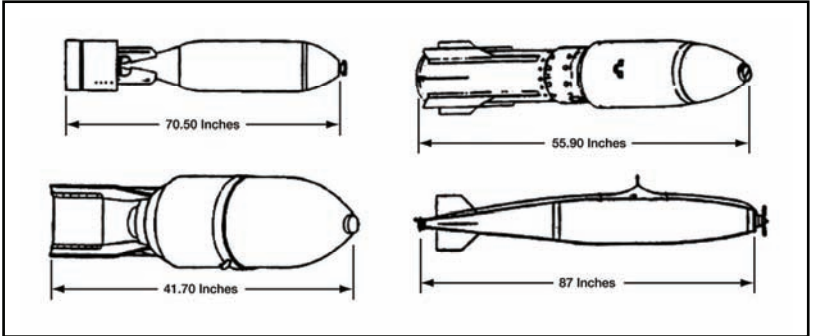

Figure 093-401-5040-1. Bombs

#### (b) Dispensers (see figure 093-401-5040-2).

- Contain numerous submunitions or bomblets.
- Most have the same characteristics of bombs.
- May be found intact or partially open.

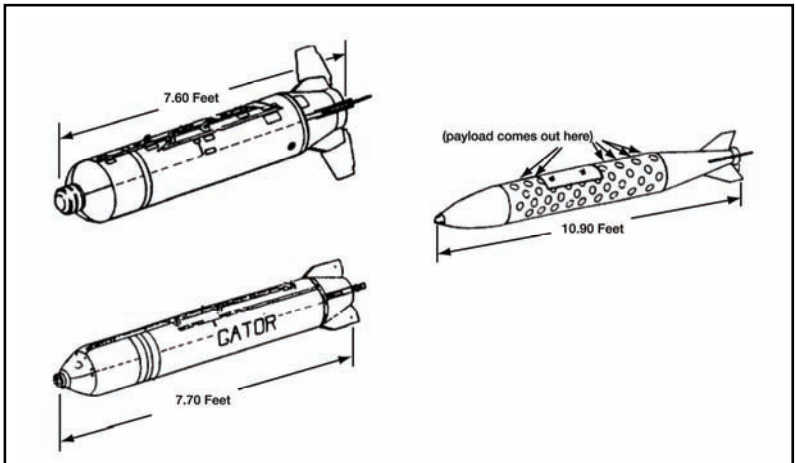

Figure 093-401-5040-2. Dispensers

## Performance Steps

(c) Submunitions (see figure 093-401-5040-3a and figure 093-401-5040-3b).

- Can contain explosive, chemical, biological, radiological, and/or incendiary hazards.
- Designed to be scattered over a wide area.
- Come in many shapes and sizes; may or may not be "bullet" shaped. May look like balls, wedges, or cylinders.
- May have fins, ribbons, parachutes, or trip wires.

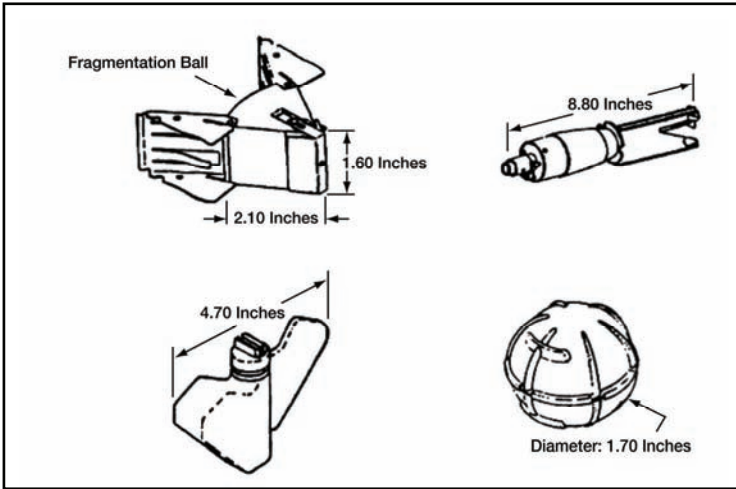

Figure 093-401-5040-3a. Submunitions

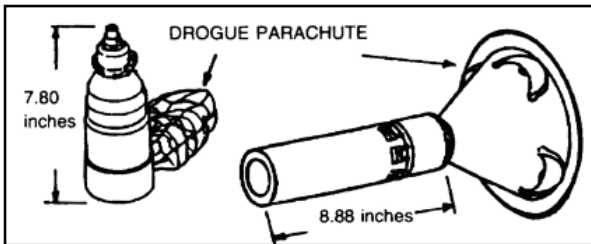

Figure 093-401-5040-3b. Submunitions

### DANGER

When a submunition is identified, leave the area by the same path you entered. There may be many more in the immediate area.

Small size does not diminish the danger of submunitions—the smallest can easily injure or kill.

## Performance Steps

### (2) Projected

(a) Projectiles (see figure 093-401-5040-4a and figure 093-401-5040-4b).

- Includes munitions from large machine guns, artillery howitzers, and naval guns.
- Range in size from 20 mm up to 16 inches in diameter and 10 to 30 inches in length.
- Most resemble a "bullet" shape.
- Can contain explosive, chemical, biological, radiological, and/or incendiary hazards.

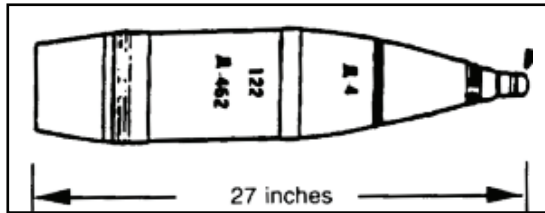

Figure 093-401-5040-4a. Projected projectile

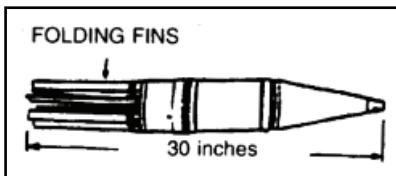

Figure 093-401-5040-4b. Projected projectile

(b) Mortars (see figure 093-401-5040-5a and figure 093-401-5040-5b).

- Most have fins and have a "bullet" shape.
- Range in size from 60 mm to 120 mm in diameter and 12 to 36 inches in length.
- Can contain explosive, chemical, and/or incendiary hazards.

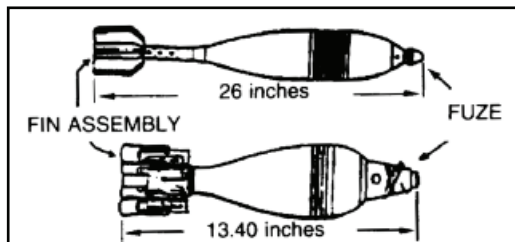

Figure 093-401-5040-5a. Mortars

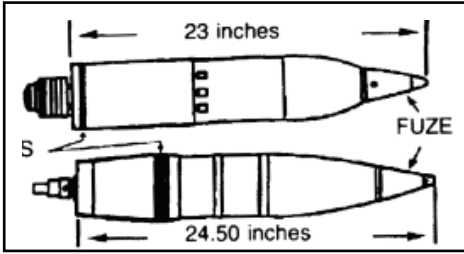

Figure 093-401-5040-5b. Mortars

(c) Rockets (see figures 093-401-5040-6a through 093-401-5040-6c).

- May or may not have fins; have some sort of rocket motor vents in back.
- Range in size from 24 inches to several feet in length.
- Can contain explosive, chemical, and/or incendiary hazards.

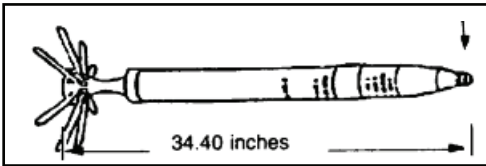

Figure 093-401-5040-6a. Rocket

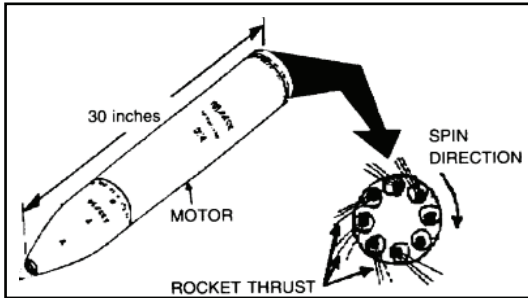

Figure 093-401-5040-6b. Rocket

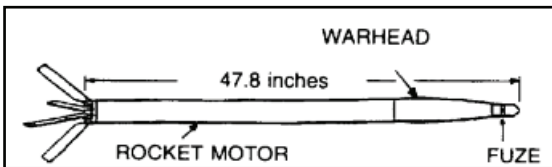

Figure 093-401-5040-6c. Rocket

## Performance Steps

(d) Guided missiles (see figure 093-401-5040-7a and figure 093-401-5040-7b).

- Most have fins; some have wires in the end for guidance.
- Very similar to rockets.
- Can contain explosive or incendiary hazards.

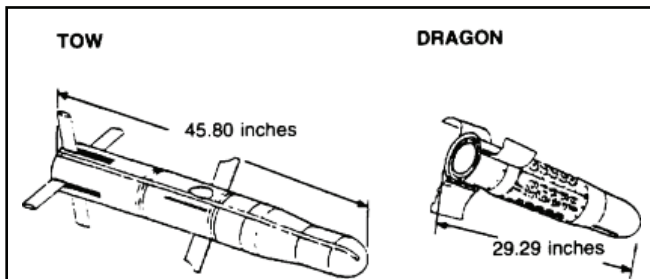

Figure 093-401-5040-7a. Guided missiles

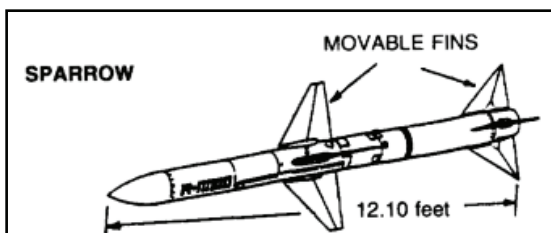

Figure 093-401-5040-7b. Guided missile

(e) Rifle grenades (see figure 093-401-5040-8a and figure 093-401-5040-8b).

- Designed to be fired from rifles or shoulder fired launchers.
- Resemble rockets but are of smaller sized.
- Can contain explosive and/or incendiary hazards.

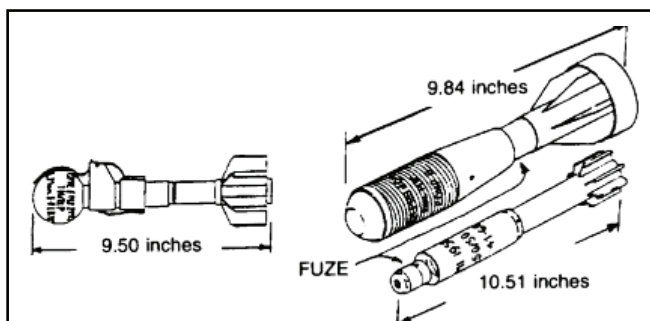

Figure 093-401-5040-8a. Rifle grenades

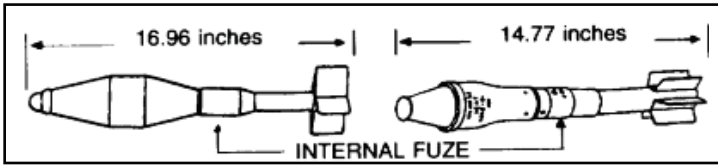

Figure 093-401-5040-8b. Rifle grenades

(3) Thrown (see figure 093-401-5040-9a and figure 093-401-5040-9b).

- Includes all types of grenades, including simulators.
- Most are round or cylindrical in shape and are small enough to be thrown by a person.
- Can contain explosive and/or incendiary hazards.
- Dud simulators require the same safety procedures as other ordnance.

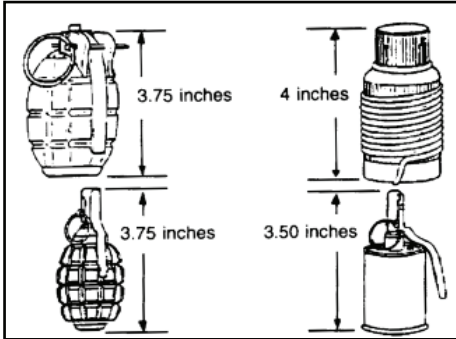

Figure 093-401-5040-9a. Thrown

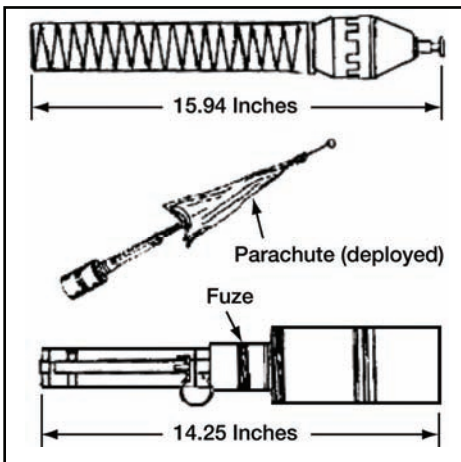

Figure 093-401-5040-9b. Thrown

**DANGER**

Never approach a grenade that was thrown and did not detonate, even if you threw it. Do not move, jar, or disturb as the fuze may function at any time.

Never pick up, move, or disturb a found grenade, even if the spoon or safety pin is attached. It may be booby-trapped to explode when disturbed.

(4) Placed (see figure 093-401-5040-10a and figure 093-401-5040-10b).

- Includes all land or sea mines.
- Range in size from 2 inches in diameter to several feet in length.
- Have a variety of fuze types pressure plates, tilt rods, trip wires, electronic sensors, or command detonated.
- Can contain explosive, incendiary, or chemical hazards.

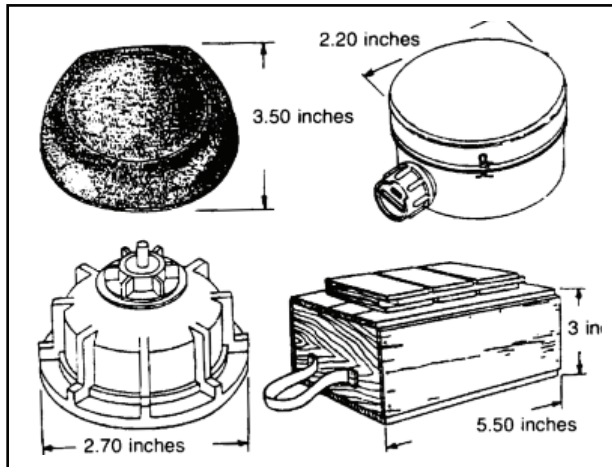

Figure 093-401-5040-10a. Placed

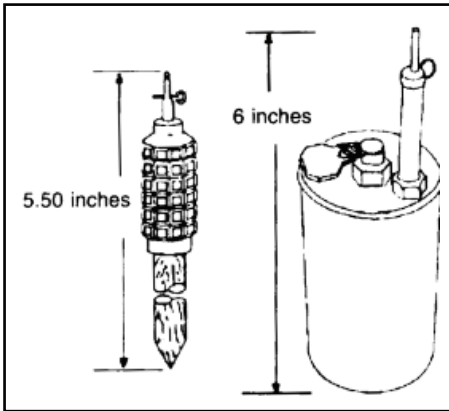

Figure 093-401-5040-10b. Placed

**DANGER**

**Consider all mines to be booby-trapped or have antidisturbance fuzing. Never attempt to uncover or remove placed ordnance.**

2. React to the UXO hazard.
  - a. Do not touch or disturb the UXO or any wires, parachutes, or anything attached or surrounding the UXO. Do not move any closer to the UXO.
  - b. If any peculiar smells, liquids, or dead animals are present, chemical or biological agents may be present; don mask and MOPP gear immediately.
3. Mark the UXO hazard.
  - a. Mark the location (without approaching any closer) with some sort of recognizable material (such as white engineer tape, marking ribbon, clothing, or signs).
  - b. Place marker above ground at waist level if possible. Note physical terrain features of the location and route back to the UXO in order for the EOD team to return to dispose of the UXO.
4. Determine the appropriate evacuation distance.
  - a. Evacuate personnel and equipment from the area surrounding the UXO:
    - (1) For bombs, dispensers, large projected munitions (90-mm diameter and larger), evacuate a 360-degree perimeter at least 600 meters.
    - (2) For submunitions, placed, thrown, small projected munitions (smaller than 90-mm diameter), evacuate a 360-degree perimeter at least 300 meters.



## Performance Steps

- b. If personnel or equipment cannot be evacuated, seek as much frontal and overhead cover as possible.
  - c. If UXO is suspected to have a chemical agent, ensure all personnel stay upwind of the item and are in full MOPP.
5. Report the UXO hazard.
- a. Report UXO hazard to your chain of command. You or your chain of command should request explosive ordnance disposal (EOD) support using the 9-Explosive Hazard Spot Report (formally the UXO Spot Report):
    - (1) Date and time of the fall, impact, or finding of the UXO item(s).
    - (2) The exact location of item(s) including grid coordinate (8-digit minimum), landmarks, reference points, or street addresses.
    - (3) The name and organization of person reporting the incident including call sign or phone number.
    - (4) Identify UXO by type (dropped, projected, thrown, placed) and subgroup.
    - (5) Any CBRN contamination present?
    - (6) What resources are threatened?
    - (7) How the UXO has affected unit mission.
    - (8) The safety measures that have been taken including the evacuation distances that have been accomplished.
    - (9) The requested priority for receiving EOD support (immediate, indirect, minor, no threat).
  - b. Be prepared to provide a guide for the EOD team.

**Evaluation Preparation:** *Setup:* Do not evaluate this task using live UXO. Use training items from your local installation training support center. Preliminary instruction of this task can be obtained by requesting support from the nearest Army EOD company. Evaluate this task during any training exercise where UXO is likely to be encountered. Place UXO training aid near personnel, facilities, or equipment (within the Soldier's area of responsibility). Soldier should identify UXO from a distance of 5 to 10 meters away or by using binoculars.

*Brief Soldier:* Tell the Soldier that he/she will be evaluated on his/her ability to properly recognize, react, mark, and report a UXO hazard and also determine the appropriate evacuation distance. The Soldier will identify the UXO by type and subgroup, take appropriate actions to react to the hazards, and report the hazard using the 9-line Explosive Hazard Spot Report (formally the UXO Spot Report).

Performance Measures	GO	NO GO
1. Recognized the UXO hazard.	___	___
2. Reacted to the UXO hazard.	___	___
3. Marked the UXO hazard.	___	___
4. Determined appropriate evacuation distance.	___	___
5. Reported the UXO hazard.	___	___

**Evaluation Guidance:** Refer to chapter 1, paragraph 1-9e, (1) and (2).

**References**

**Required:** FM 21-16 and GTA 9-12-1

**Related:**

---

## 171-137-0001

### Search Vehicles in a Tactical Environment

**Conditions:** You have been given the mission and authority to search vehicles. A search area is available as are security personnel, an occupied vehicle, and an improvised mirror device.

**Standards:** Stop the vehicle and inform the occupants of the reason for the search. Identify the occupants by looking at their drivers' licenses or identification cards (IDs). Search the vehicle, inside and out, following a sequenced search pattern. Release the vehicle to the driver, if prohibited items were not found. Apprehend the offender if prohibited items were found and notify your supervisor.

---

#### Performance Steps

**WARNING**

When performing any task outside of or off of the vehicle in a contemporary operational environment (COE), always be aware of possible threat snipers.

**WARNING**

When performing any task outside of the vehicle in a COE, wear your combat protective gear (Kevlar®, body armor and protective mask) according to your unit's tactical standing operating procedures (TSOPs).

**WARNING**

Always be aware of your surroundings; you must be prepared to react to several types of threats—such as: suicide bombers (mounted and dismounted), mortar attacks, and rocket-propelled grenade (RPG) attacks.

**Note:** At least one member of the search team must provide security at all times while others conduct the search.

1. Stop the vehicle.
2. Inform the occupants of the reason for the search.
3. Identify the occupants by looking at their drivers' licenses or ID cards.
4. Direct the occupants to get out of the vehicle.
5. With the exception of the driver, direct the occupants to move to a place about 5 meters from the vehicle and out of the flow of traffic where they can be observed.
6. Direct the driver to open all doors and compartments, to include the ashtray, glove box and/or armrest, trunk, and hood.

## Performance Steps

**Note:** At this point, the driver joins the other occupants of the car about 5 meters from the vehicle.

**Note:** Searching the occupants of the vehicle is covered under a separate task (171-137-0002). The results of the vehicle search may require that a personal search be conducted at the same time.

7. Search the following areas on the vehicle:

**Note:** Use an improvised mirror device to search the undercarriage and other areas that are difficult to see.

**Note:** While conducting the search look for any electrical wires that seem out of place or unidentifiable foreign objects.

a. Search the inside of the vehicle, to include—

- (1) Behind and under the seat.
- (2) Under the dashboard.
- (3) Inside the glove and tool compartment.
- (4) Above the sun visor.

b. Search the outside of the vehicle, in sequence, to include—

- (1) Under the left front fender well and behind the wheel.
- (2) Under the front bumper and behind and under the grill.
- (3) Under the hood and all areas behind the radiator and around the engine.
- (4) Under the right front fender well and behind the wheel.
- (5) Under the right side of the body, back to and including the right rear fender well, and behind the wheel.
- (6) Inside cargo areas and the trunk.
- (7) Under and behind the rear bumper.
- (8) Under the left rear fender well and behind the wheel.
- (9) Under the left side of the body, back to the left front fender well.
- (10) Top of the vehicle.
- (11) Around the fuel tank(s).

8. If prohibited items are not found in the vehicle, release the vehicle to the driver.

9. If prohibited items are found in the vehicle, apprehend the offender and notify your supervisor.

---

**Evaluation Preparation:** *Setup:* Tell the Soldier that he/she has been given the mission and authority to search vehicles. A search area is available as are security personnel, an occupied vehicle, and an improvised mirror device.

*Brief Soldier:* Tell the Soldier that he/she must stop the vehicle and inform the occupants of the reason for the search. The Soldier will identify the occupants by looking at their drivers' licenses or identification cards (IDs). He/she will search the vehicle, inside and out, following a sequenced search pattern. He/she will release the vehicle to the driver, if prohibited items were not found and apprehend the offender if prohibited items are found and notify your supervisor.

Performance Measures	GO	NO GO
1. Stopped the vehicle.	___	___
2. Informed the occupants of the reason for the search.	___	___
3. Identified the occupants by looking at their drivers' licenses or ID cards.	___	___
4. Directed the occupants to get out of the vehicle.	___	___
5. With the exception of the driver, directed the occupants to move to a place about 5 meters from the vehicle and out of the flow of traffic where they could be observed.	___	___
6. Directed the driver to open all doors and compartments, to include the ashtray, glove box and/or armrest, trunk, and hood.	___	___
7. Searched the vehicle in a sequenced manner.	___	___
8. If prohibited items were not found in the vehicle, released the vehicle to the driver.	___	___
9. If prohibited items were found in the vehicle, apprehended the offender and notified the supervisor.	___	___

**Evaluation Guidance:** Refer to chapter 1, paragraph 1-9e, (1) and (2).

**References**

**Required:**

**Related:** FM 19-10, FM 3-20.15 (FM 17-15), and FM 3-20.98 (FM 17-98)

## 191-376-5140

### Search a Vehicle for Explosive Devices or Prohibited Items at an Installation Access Control Point

**Conditions:** You are at the vehicle search lane at an installation access control point. You are given a search mirror, a flashlight, a reflective vest, the local standing operating procedure (SOP), and a directive to search an identified vehicle for suspected explosive devices or prohibited items.

**Standards:** Search the undercarriage and the exterior and interior of a vehicle, and find any explosive devices or prohibited items present.

## Performance Steps

1. Stop the vehicle using hand-and-arm signals.

### DANGER

**Always position yourself so that you are highly visible to traffic with good approach sight distance, and wear reflective vests so that the vehicle driver can see you easily. Never step into the path of an approaching vehicle to direct movement or to stop the vehicle.**

2. Direct the driver to turn off the engine and apply the parking brake.
3. Interview the driver and vehicle occupants.
  - a. Identify yourself to the driver and occupants.
  - b. Inform the driver that the vehicle must be searched as a condition for entry onto the installation.
  - c. Identify each occupant by physically taking possession of and looking at the military or Department of Defense (DOD) identification (ID) card, state driver's license, or another form of a state or federal government-issued photo ID and comparing the photo to the person.

*Note:* Notify your supervisor and the military police if you feel that the photo does not match the person being identified or if the ID has been altered.

- d. Request to see the following documentation:
  - (1) Vehicle registration.
  - (2) Proof of vehicle insurance.

*Note:* Notify your supervisor and the military police if you feel that the documentation you are being shown is not valid.

- e. Determine the specific reason why the driver and occupants need access to the installation by asking questions such as—
  - (1) Where are you going?
  - (2) Who are you going to meet?
  - (3) Do you drive this vehicle most of the time?
  - (4) Would there be any contraband or prohibited items in this vehicle?
  - (5) Has this vehicle had any repairs recently? If so, what?
- f. Maintain eye contact with the driver throughout the interview and report suspicious behavior to the supervisor.
- g. Notify the supervisor and military police if the driver appears impaired from the use of alcohol or drugs and if any suspected prohibited items are in plain view during the interview.

4. Direct the occupants to exit the vehicle.

## Performance Steps

- a. Direct the driver to open all interior compartment doors, the hood, the trunk, and rear doors (if applicable) of the vehicle, while maintaining constant observation.
  - b. Direct the occupants to move to a designated safe area (about 5 meters from the vehicle and/or out of the flow of traffic) where they can be observed.
5. Search the undercarriage of the vehicle.
- a. Use a flashlight and a mirror to carefully inspect under the vehicle.
  - b. Check for indicators such as new frame welds; items taped or attached to the frame; an unusual looking muffler; a fresh undercoating; and signs of recent installation of components such as a fuel tank, muffler, or other items.
6. Search the exterior of the vehicle.
- a. Check for general indicators of explosive devices or prohibited items while searching the exterior of the vehicle. Check for the following:
    - (1) Anything unusual in factory-built compartments.
    - (2) New or shiny bolts and/or screws.
    - (3) Unusual scratches, possibly made by screwdrivers, wrenches, or similar tools.
    - (4) Signs of tampering, such as broken parts or bent sheet metal.
    - (5) Unusually clean or dirty components and areas.
    - (6) Wire and tape stored in the vehicle.
    - (7) New or broken welds.
    - (8) Unusual fingerprints of grease and/or oil in otherwise clean areas.
    - (9) Fresh bodywork (such as fresh fiber glassing and fresh paint).
    - (10) Fresh wiring and electrical tape.
    - (11) New caulking.
    - (12) A missing or altered vehicle identification number.
    - (13) False compartments that are not part of the vehicle design.

### WARNING

Do not wear jewelry or other dangling items that can become snagged on a vehicle. Always ensure that the engine is off and the parking brake is set before beginning the inspection.

- b. Check the exterior front, including—
  - (1) Headlights that are not working.
  - (2) A modified front grill or false compartment.
  - (3) No access to the front bumper cavity.
- c. Check the exterior sides, including—
  - (1) Compartments, new welds, taped items, or fresh paint in the front fender wells.
  - (2) Doors that feel heavy when swung.

(3) Foreign items in the gas tank tube (driver opens the gas tank for inspection).

**DANGER**

**Death or serious injury may result if you breathe toxic agents while searching the gas tank tube of vehicles.**

- d. Check the tires, including—
    - (1) New tires.
    - (2) Tires with a solid sound.
    - (3) Strange odor from an air valve.
    - (4) Unusually clean or dirty lug nuts or hubcaps compared to other wheels.
  - e. Check the exterior rear, including—
    - (1) Taillights that are not working.
    - (2) No access to the rear bumper cavity.
  - f. Check the tailgate (if applicable), including—
    - (1) An unusually heavy tailgate.
    - (2) Fresh paint or body filler.
    - (3) Inconsistent or nonhollow sounds when tapped.
  - g. Check the pickup bed (if applicable), including—
    - (1) Inconsistent or nonhollow sounds when tapped.
    - (2) Fresh paint or body filler.
    - (3) An unusually thick floor.
    - (4) Unusual welds and/or seams.
    - (5) Any caulking.
  - h. Check the cargo area (if applicable), including—
    - (1) Fresh paint or body filler.
    - (2) Inconsistent or nonhollow sounds when tapped.
    - (3) An unusually thick floor.
    - (4) A false ceiling.
    - (5) Any caulk and/or glue.
    - (6) Any strange smell.
  - 7. Search the engine compartment.
    - a. Look for a large battery box or extra battery.
    - b. Look for odd and/or clean wires.
    - c. Look for larger components (air cleaner and fan blade shrouds).
-

**WARNING**

Never place your hands in the vicinity of the fan blades while conducting the search. Some vehicles are equipped with an automatic cooling system that may cause the fan blades to start operating after the ignition switch is in the off position.

- d. Identify any unusual odor indicating that containers may contain fuel.
  - e. Look for foreign objects in the air filter cavity.
  - f. Look for the cold air filter.
  - g. Look for freshly painted areas, new welds, shiny bolts, or sheet metal work on firewalls.
  - h. Check for a clean engine in a dirty car.
  - i. Check the hood to see if it feels heavy when opened and closed. Have the driver open the hood, but move the hood up and down yourself.
  - j. Look for a false wall or modified fender compartment.
  - k. Identify any clean or wiped areas.
8. Search the trunk compartment, if applicable.
- a. Check for a new trunk mat and/or carpet.
  - b. Check for caulk, glue, or any other strange smells.
  - c. Check the trunk lid to see if it feels heavy when opened and closed.
  - d. Look for a raised floor.
  - e. Identify any strange odors from the spare tire.
  - f. Listen for nonhollow or inconsistent sounds in the walls.
  - g. Look for an unusual space between the back seat and trunk wall.
  - h. Look to see if the spare tire is not flush with the floor.
9. Search the interior of the vehicle.
- a. Search the dash, including—
    - (1) Electrical components. See if the components function or if the light emitting diode (LED) is on when the vehicle power is off.
    - (2) New, damaged, or scratched screws.
    - (3) Plugged air vents.
    - (4) Broken or missing blowers.
  - b. Look for a false compartment in the glove box.
  - c. Look for unusual lumps or bulges in the front and/or rear seats.



## Performance Steps

- d. Feel for rigid front and/or rear seats.
  - e. Look for a false or modified ceiling.
  - f. Look for an unusually thick floor.
  - g. Look for stress cracks in the windshield (no stone impact mark).
10. Take action when the search reveals suspected explosive devices or prohibited items in the vehicle.
- a. Search for explosive devices.
    - (1) Never attempt to handle or disarm suspected explosive devices.
    - (2) Suspend all radio and cellular phone traffic for 100 meters around the vehicle.
    - (3) Secure the driver and all occupants of the vehicle and notify the supervisor and military police.
    - (4) Immediately evacuate the surrounding area.
    - (5) Secure the scene until it is cleared by explosive ordnance disposal (EOD) personnel or until you are properly relieved.
    - (6) Release the driver and occupants to the supervisor or military police along with any documentation and identification collected.
  - b. Search for prohibited items.
    - (1) Never handle the prohibited items unless ordered by the supervisor or military police.
    - (2) Notify the supervisor and military police.
    - (3) Secure the driver and all occupants of the vehicle.
    - (4) Secure the scene until it is cleared by the supervisor or until you are properly relieved.
    - (5) Release the driver and occupants to the supervisor or military police along with any documentation and identification collected.
11. Release the driver and occupants if no explosive devices or prohibited items are found or if suspected items are cleared by the military police or EOD personnel.
- a. Give ID cards and all gathered documentation back to the driver.
  - b. Help the driver safely enter the flow of traffic (if applicable).

---

**Evaluation Preparation:** *Setup:* Provide the Soldier with a vehicle to search in a well-lit area. Identify a role player and a role player occupant for the vehicle. Ensure that role players are authorized to operate the vehicle prior to beginning this task. Notify role players that they are to comply with and follow all instructions given by the Soldier searching the vehicle. Have role players place a dummy explosive device or dummy prohibited item somewhere in, under, or on the vehicle to be searched prior to the Soldiers arriving to test. The dummy explosive device or dummy prohibited item can be handmade. It should not be large enough to gain immediate discovery yet not so small that it cannot be detected by a highly motivated Soldier

conducting a reasonable search. Give the Soldier a search mirror, a flashlight, a reflective vest, and the local SOP.

*Brief Soldier:* Tell the Soldier that he/she has an armed partner pulling overwatch security for him/her through the duration of this task. The tester will play the role of the Soldier's supervisor and the military police. Point at the vehicle that you want the Soldier to search and tell the Soldier to conduct this task as outlined in the performance steps. Tell the Soldier that the vehicle has a role player driver and a role player occupant, and that both role players will respond to his/her instructions.

Performance Measures	GO	NO GO
1. Stopped the vehicle using hand-and-arm signals.	_____	_____
2. Directed the driver to turn off the engine and apply the parking brake.	_____	_____
3. Interviewed the driver and vehicle occupants.	_____	_____
4. Directed the occupants to exit the vehicle.	_____	_____
5. Searched the undercarriage of the vehicle.	_____	_____
6. Searched the exterior of the vehicle.	_____	_____
7. Searched the engine compartment.	_____	_____
8. Searched the trunk compartment, if applicable.	_____	_____
9. Searched the interior of the vehicle.	_____	_____
10. Took action when the search revealed suspected explosive devices or prohibited items in the vehicle.	_____	_____
11. Released the driver and occupants if no explosive devices or prohibited items were found or if suspected items were cleared by the military police or EOD personnel.	_____	_____

**Evaluation Guidance:** Refer to chapter 1, paragraph 1-9e, (1) and (2).

**References**

**Required:**

**Related:** AR 190-13 and AR 525-13

**191-376-5141**

**Search a Commercial Vehicle for Explosive Devices or Prohibited Items at an Installation Access Control Point**

**Conditions:** You are at the commercial-vehicle search lane at an installation access control point. Given a search mirror, a flashlight, a reflective vest, the local standing operating procedure (SOP), and a directive to search an identified vehicle for suspected explosive devices or prohibited items.

**Standards:** Search the commercial vehicle and find any explosive devices or prohibited items present.

## Performance Steps

1. Stop the vehicle using hand-and-arm signals.

### CAUTION

Always position yourself so that you are highly visible to traffic with a good approach sight distance and wear a reflective vest so that the vehicle driver can see you easily. Never step into the path of an approaching vehicle to direct movement or to stop the vehicle.

2. Direct the driver to turn off the engine and apply the parking brake.
3. Interview the driver and vehicle occupants.
  - a. Identify yourself to the driver and occupants.
  - b. Inform the driver that the vehicle must be searched as a condition for entry onto the installation.
  - c. Identify each occupant by physically taking possession of and looking at the military or Department of Defense (DOD) identification (ID) card, state driver's license, or another form of a state or federal government-issued photo ID card, and comparing the photo to the person.

**Note:** Notify your supervisor and the military police if the photo on the ID card does not match the individual being identified or if the ID card has been altered.

- d. Request to see the following documentation:

- (1) Vehicle registration.
- (2) Logbook or itinerary.
- (3) Manifest, shipping papers, or bill of lading.

**Note:** Notify your supervisor and the military police if you feel the documentation you are being shown is not valid.

- e. Determine specifics of a cargo shipment by asking questions such as—
  - (1) Where are you going?
  - (2) What is your cargo and did you watch it being loaded?
  - (3) What is the name and position of the person you are delivering the cargo to?
  - (4) Do you drive this vehicle most of the time?
  - (5) Are there any contraband or prohibited items in this vehicle?
  - (6) Has this vehicle had any repairs recently? If so, what?
- f. Maintain eye contact with the driver, observe the occupants throughout the interview, and report suspicious behavior to the supervisor.
- g. Notify the supervisor and the military police if the driver appears impaired from the use of alcohol or drugs or if any suspected prohibited items are in plain view during the interview.

4. Direct the occupants to exit the vehicle.

## Performance Steps

- a. Direct the driver to open all interior compartments doors, the hood, the trunk, and rear doors (if applicable) of the vehicle, while maintaining constant observation.
  - b. Direct the occupants to move to a designated safe area (about 5 meters from the vehicle, out of the flow of traffic) where they can be observed.
5. Identify the type of commercial vehicle being searched.
- a. Determine if the commercial vehicle is a tractor (see figure 191-376-5141-1).

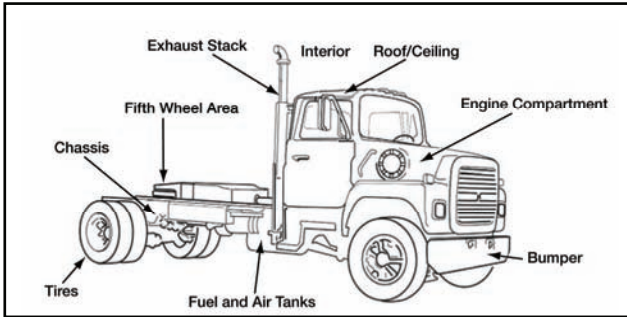

Figure 191-376-5141-1. Tractor

- b. Determine if the commercial vehicle is a trailer (see figure 191-376-5141-2).

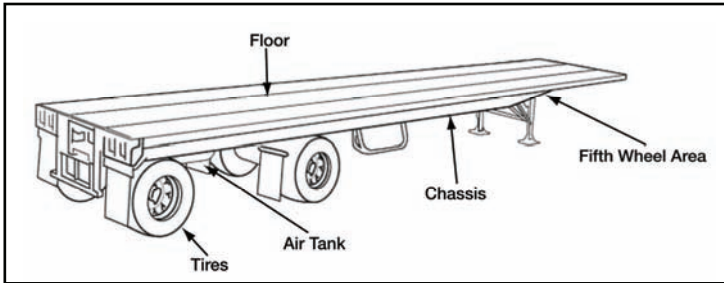

Figure 191-376-5141-2. Trailer

- c. Determine if the commercial vehicle is a hot-liquid asphalt tanker (see figure 191-376-5141-3).
-

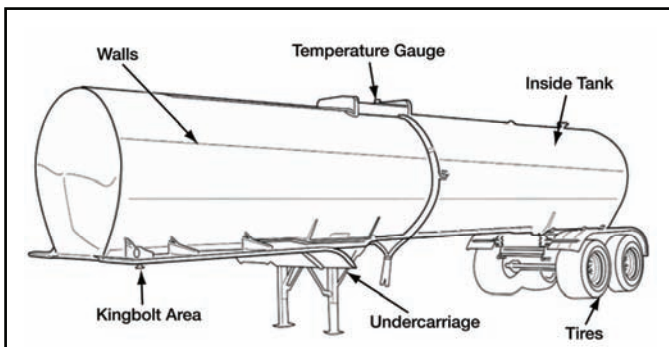

Figure 191-376-5141-3. Hot-liquid asphalt tanker

d. Determine if the commercial vehicle is a closed hopper vessel (see figure 191-376-5141-4).

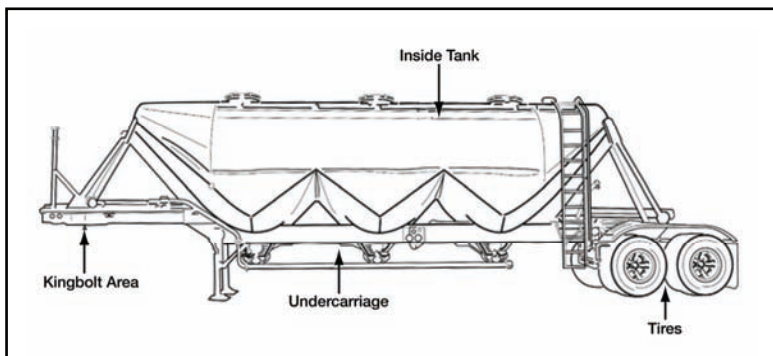

Figure 191-376-5141-4. Closed hopper vessel

e. Determine if the commercial vehicle is a gasoline trailer (see figure 191-376-5141-5).

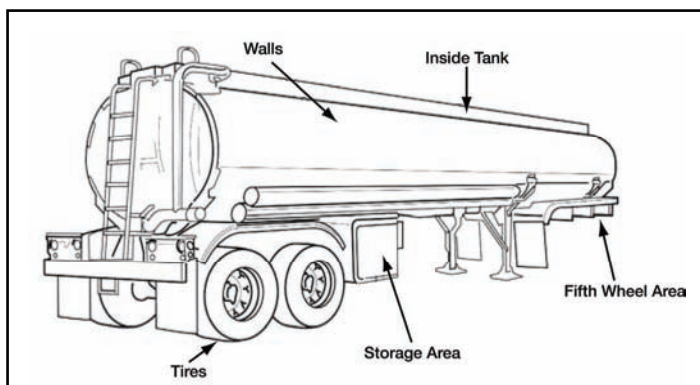
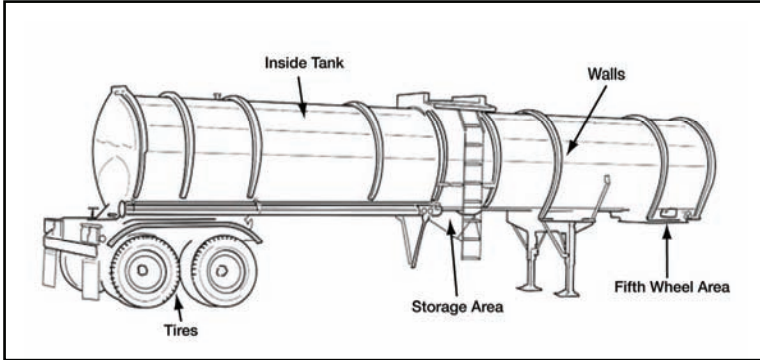

Figure 191-376-5141-5. Gasoline trailer

**Performance Steps**

f. Determine if the commercial vehicle is a liquid tanker (see figure 191-376-5141-6).



**Figure 191-376-5141-6. Liquid tanker**

g. Determine if the commercial vehicle is a propane tanker (see figure 191-376-5141-7).

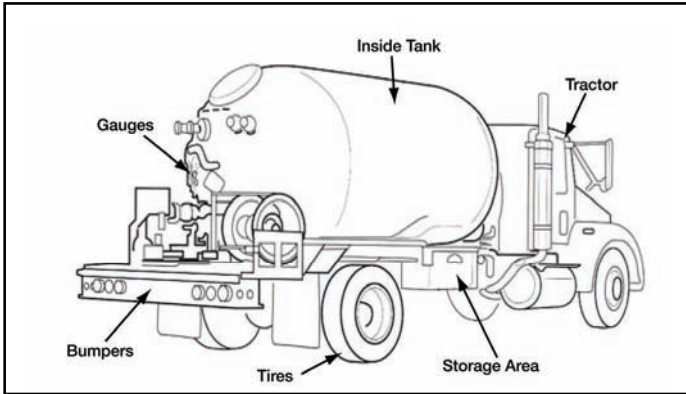
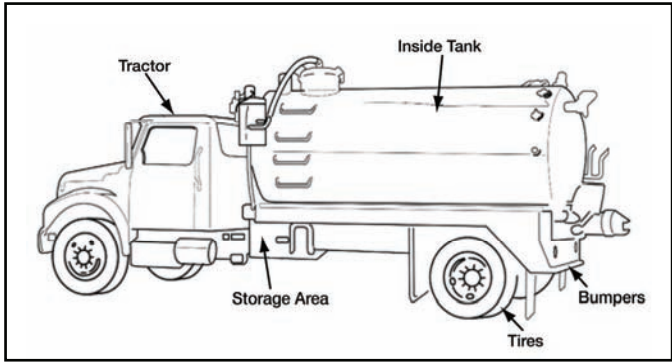

**Figure 191-376-5141-7. Propane tanker**

h. Determine if the commercial vehicle is a septic service truck (see figure 191-376-5141-8).

---

**Performance Steps**



**Figure 191-376-5141-8. Septic service truck**

- i. Determine if the commercial vehicle is a semivan trailer, straight-box truck, or a step van (see figure 191-376-5141-9).

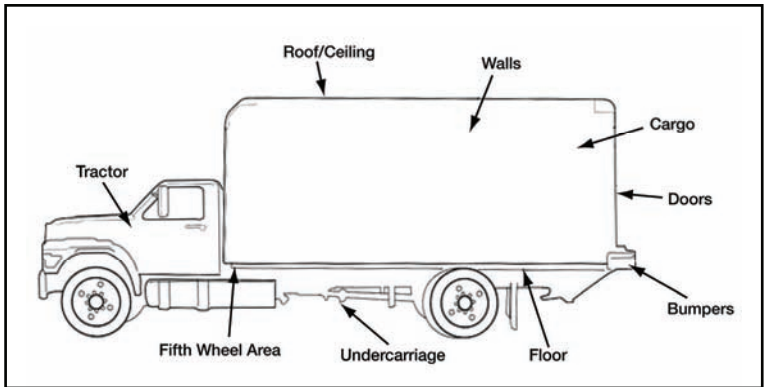

**Figure 191-376-5141-9. Semivan trailer/straight-box truck/step van**

- j. Determine if the commercial vehicle is a refrigeration trailer (see figure 191-376-5141-10).

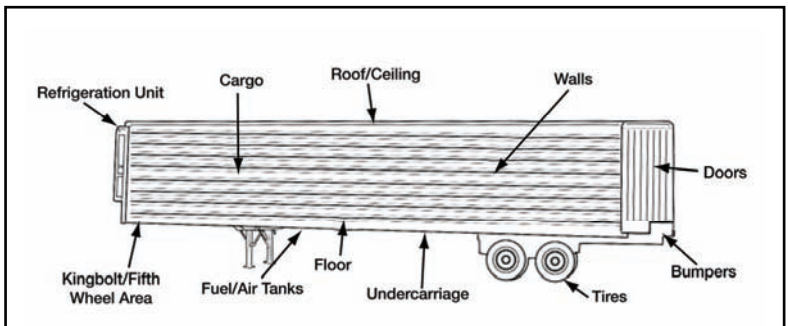

**Figure 191-376-5141-10. Refrigeration trailer**

**Performance Steps**

- k. Determine if the commercial vehicle is a garbage truck (permanent bed) (see figure 191-376-5141-11).

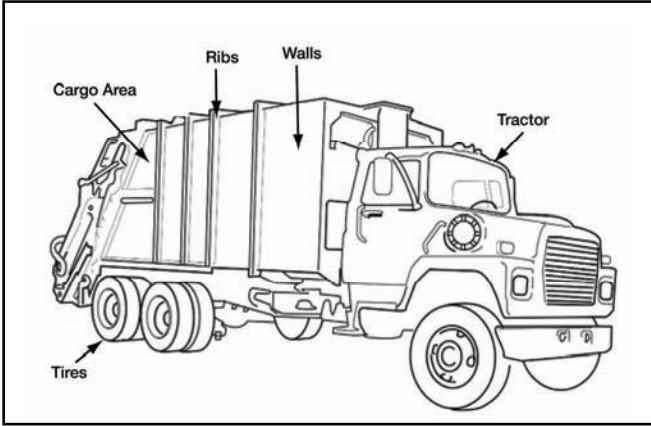

**Figure 191-376-5141-11. Garbage truck (permanent bed)**

- l. Determine if the commercial vehicle is a garbage truck (dumpster) (see figure 191-376-5141-12).

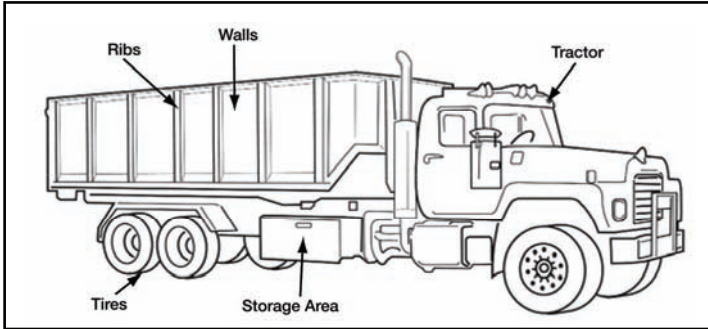

**Figure 191-376-5141-12. Garbage truck (dumpster)**

- m. Determine if the commercial vehicle is a bus (see figure 191-376-5141-13).
-



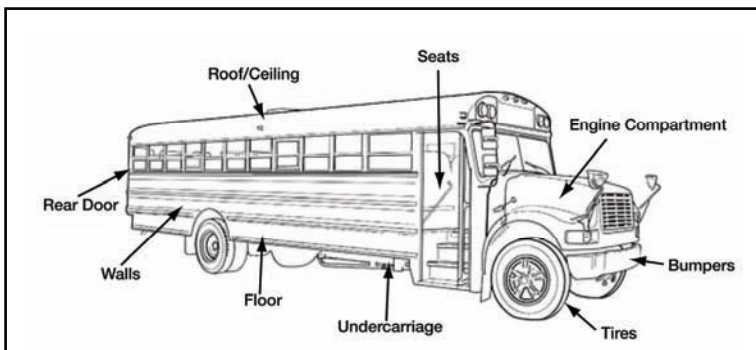

Figure 191-376-5141-13. Bus

n. Determine if the commercial vehicle is a concrete truck or mixer (see figure 191-376-5141-14).

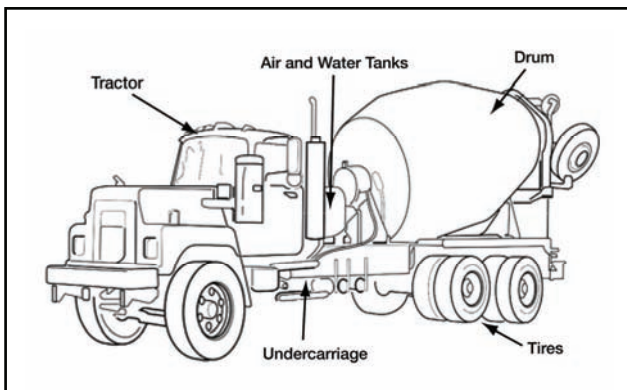

Figure 191-376-5141-14. Concrete Truck or mixer

o. Determine if the commercial vehicle is a dump truck (see figure 191-376-5141-15).

---

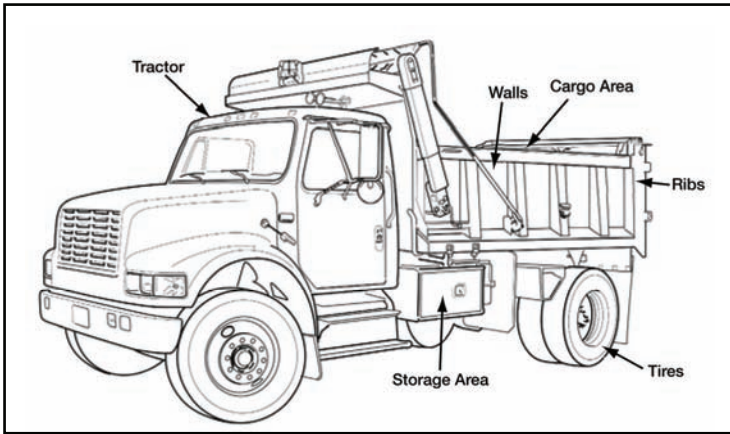

Figure 191-376-5141-15. Dump truck

p. Determine if the commercial vehicle is a camper or motor home (see figure 191-376-5141-16).

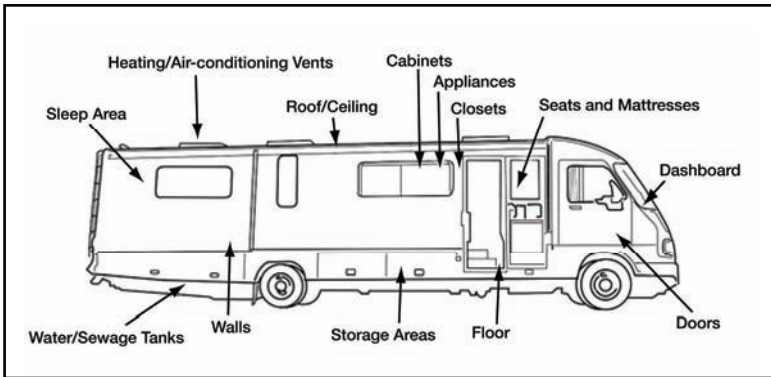

Figure 191-376-5141-16. Camper or motor home

q. Determine if the commercial vehicle is a boat and boat trailer (see figure 191-376-5141-17).

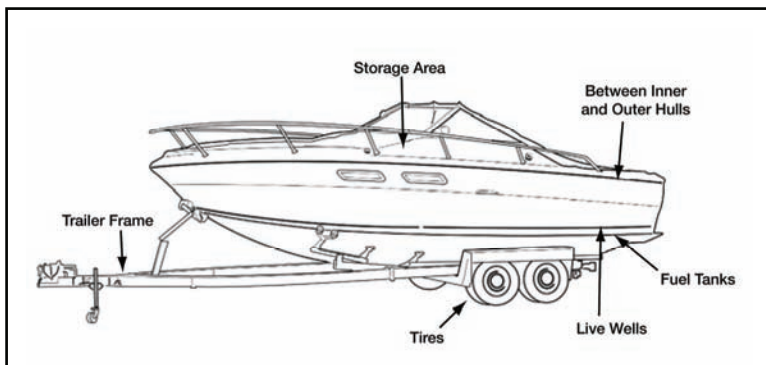

Figure 191-376-5141-17. Boat and boat trailer

6. Search the undercarriage and chassis of the vehicle.

*Note:* Use a flashlight and mirror to carefully inspect under the vehicle for general indicators of explosive devices or prohibited items while searching the entire vehicle.

7. Search the identified commercial vehicle, paying particular attention to high-threat "hot spot" areas denoted in figures 191-376-5141-1 through 191-376-5141-17.

### DANGER

**Do not open the tank or any discharge valve on commercial vehicles. Death or serious injury may result if you breathe toxic agents while searching commercial vehicles containing gas, propane, or other toxic agents. The tank areas on commercial vehicles, in most cases, cannot be physically inspected.**

8. Take action when the search reveals suspected explosive devices or prohibited items in the vehicle.
  - a. Explosive devices.
    - (1) Never attempt to handle or disarm suspected explosive devices.
    - (2) Suspend all radio and cellular phone traffic 100 meters around the vehicle.
    - (3) Secure the driver and all occupants of the vehicle, and notify the supervisor and military police.
    - (4) Immediately evacuate the surrounding area.
    - (5) Secure the scene until it is cleared by explosive ordnance disposal (EOD) personnel or until you are properly relieved.
    - (6) Release the driver and occupants to the supervisor or military police along with any documentation and identification collected.
  - b. Prohibited items.

## Performance Steps

- (1) Never handle the prohibited items unless ordered by the supervisor or military police.
  - (2) Notify the supervisor and military police.
  - (3) Secure the driver and all occupants of the vehicle.
  - (4) Secure the scene until you are cleared by the supervisor or until you are properly relieved.
  - (5) Release the driver and occupants to the supervisor or military police along with any documentation and identification collected.
9. Release the driver and occupants if no explosive devices or prohibited items are found or if suspected items are cleared by the military police or EOD personnel.
- a. Give ID cards and all gathered documentation back to the driver of the vehicle.
  - b. Help the driver safely enter the flow of traffic (if applicable).

**Evaluation Preparation:** *Setup:* Provide the Soldier with a commercial vehicle to search in a well-lit area. Vehicles in the DOD inventory may be used in this task if civilian commercial vehicles are not available. Identify a role player driver and a role player occupant for the commercial vehicle. Ensure that the role players are authorized to operate the equipment prior to beginning this task. Notify the role players that they are to comply with and follow all instructions given by the Soldier searching the vehicle. Have the role players place a dummy explosive device or dummy prohibited item somewhere in, under, or on the commercial vehicle to be searched prior to the Soldiers arriving to test. The dummy explosive device or dummy prohibited item can be handmade. It should not be large enough to gain immediate discovery yet not so small that it cannot be found by a highly motivated Soldier conducting a reasonable search. Give the Soldier a search mirror, a flashlight, a reflective vest, and the local SOP.

*Brief Soldier:* Tell the Soldier that he/she has an armed partner pulling overwatch security for him/her for the duration of this task. The tester will play the role of the Soldier's supervisor and the military police. Point at the commercial vehicle that you want the Soldier to search and tell the Soldier to conduct this task as outlined in the performance steps. Tell the Soldier that the commercial vehicle has a role player driver and a role player occupant, and that both role players will respond to your instructions.

Performance Measures	GO	NO GO
1. Stopped the vehicle using hand-and-arm signals.	___	___
2. Directed the driver to turn off the engine and apply the parking brake.	___	___
3. Interviewed the driver and vehicle occupants.	___	___
4. Directed the occupants to exit the vehicle.	___	___
5. Identified the type of commercial vehicle being searched.	___	___
6. Searched the undercarriage and chassis of the vehicle.	___	___

Performance Measures	GO	NO GO
7. Searched the identified commercial vehicle, paying particular attention to high-threat "hot spot" areas.	_____	_____
8. Took action when the search revealed suspected explosive devices or prohibited items in the vehicle.	_____	_____
9. Released the driver and occupants if no explosive devices or prohibited items were found or if suspected items were cleared by military police or EOD personnel.	_____	_____

**Evaluation Guidance:** Refer to chapter 1, paragraph 1-9e, (1) and (2).

**References**

**Required:**

**Related:** AR 190-13 and AR 525-13

## 191-376-5151

### Control Access to a Military Installation

**Conditions:** You are on duty performing installation access control. You are given a reflective vest, a duty uniform, the local standing operating procedure (SOP), and a directive to check all persons in vehicles and pedestrians attempting to enter the installation.

**Standards:** Ensure that only authorized traffic enters the installation and take action to prevent unauthorized personnel, packages, and/or vehicles from entering the installation.

#### Performance Steps

1. Determine if the person attempting entry is a pedestrian or is in a vehicle.
 

*Note:* If the individual is a pedestrian, skip to step 7.
2. Perform a visual check of the exterior front of the vehicle as it approaches.
  - a. Look at the windshield or bumper and verify that the Department of Defense (DOD) decal is visible and valid.
  - b. Observe the approach of the vehicle for anything that would arouse suspicion and indicate foul play or terrorist activity.
3. Stop the vehicle by using hand-and-arm signals.

#### DANGER

**Always position yourself so you are highly visible to traffic with good approach sight distance. Never step into the path of an approaching vehicle to direct movement or to stop the vehicle.**

- a. Position yourself so that you are on the driver's side (where the center line of the road would be) of the approaching vehicle.

## Performance Steps

- b. Assume a comfortable balanced stance.
        - c. Direct the vehicle to stop verbally and/or by extending your arm.
    4. Identify the driver and vehicle occupants.
      - a. Identify each occupant by physically taking possession of, and looking at, the military or DOD identification (ID) card, state driver's license, or another form of a state or federal government-issued photo ID card.
        - (1) Compare the photo to the person and inspect the ID card to ensure that it is valid and has not been altered.
        - (2) Notify your supervisor and the military police if the photo does not match the person, if you are unsure that the ID card you are being shown is valid, or if you suspect that the ID card has been altered.
      - b. Maintain eye contact with the driver and observe all occupants throughout the interview, and report suspicious behavior to your supervisor.
  5. Determine if the vehicle and occupants are authorized access.
    - a. Determine if the vehicle has a DOD decal. If it does not, direct the driver to pull to the inspection lane to be checked.
    - b. Determine if unidentified persons can produce authorized forms of a state or federal government-issued photo ID card. If not direct them to the access control operations center to possibly be searched, to be checked against the barred persons list, to be vouched for by an authorized person on the installation, or to be denied access to the installation.
- Note:* Keep in mind that the driver or other occupants of the vehicle may be under duress by the unidentified person. Because of this potential problem, local SOPs and commanders may implement a duress code policy that would alert access controllers and as to what actions to take.
6. Grant or deny the vehicle and occupants access to the installation by using a verbal command and/or hand-and-arm signals.

*Note:* Local SOPs will dictate whether the vehicle not possessing a DOD decal will be issued a temporary visitor's pass.

    - a. Grant access and signal the vehicle to proceed if the vehicle and occupants are authorized access to the installation.
    - b. Deny access to the installation if the vehicle does not have a DOD decal and/or the occupants do not have proper ID. Notify your supervisor and the military police of any suspicious activity.
  7. Perform a visual check of the person approaching the pedestrian gate.
    - a. Look to see if the person is carrying a briefcase, box, or any item that should be checked according to the local SOP.

## Performance Steps

b. Observe the person for unusual bulges in clothing and for being dressed inappropriately for the time of year or season (for example, a long jacket in hot weather).

c. Observe the person approaching for anything that would arouse suspicion or indicate terrorist activity.

8. Stop the person by using a verbal command and/or hand-and-arm signals.

9. Identify each person by physically taking possession of and looking at the military or DOD ID card, state driver's license, or another form of a state or federal government-issued photo ID card.

a. Compare the photo to the person and inspect the ID card to ensure that it is valid and has not been altered.

b. Maintain eye contact with the person throughout the interview and report suspicious behavior to the supervisor.

c. Inquire about the contents of any suspicious briefcase, package, or container.

d. Notify your supervisor and the military police desk if the photo does not match the person, if you are unsure that the identification you are being shown is valid, or if you suspect that the ID card has been altered.

10. Grant or deny the person access to the installation by using a verbal command and/or hand-and-arm signals.

a. Direct the person to the access control operations center if the person cannot produce an authorized form of a state or federal government-issued photo ID card, to be checked against the barred persons list, to be vouched for by an authorized person on the installation, or to be denied access to the installation.

b. Grant access to personnel producing the proper identification and signal to proceed.

c. Deny the personnel access to the installation if they do not have proper ID.

d. Notify your supervisor of any problems or if anything is suspicious.

---

**Evaluation Preparation:** *Setup:* Provide the Soldier with a training site that is suitable for access control operations and is well-lit. Use vehicles in the DOD inventory with a DOD decal, if a civilian vehicle with a DOD decal is not available. Identify role players to act as either a driver or a pedestrian attempting entry onto the installation. If role players are in a vehicle, ensure that they are authorized to operate the equipment prior to beginning this task. Instruct role players to comply with instructions given by the Soldier being tested. The tester will determine what type of ID card the role players use.

*Brief Soldier:* Tell the Soldiers they can familiarize themselves with the local SOP before they perform the task and refer to the SOP during the task, if needed. The

tester will play the role of the supervisor or military police, if needed. Tell the Soldier to conduct this task as outlined in the performance steps and that the role players are compliant and will obey their instructions.

Performance Measures	GO	NO GO
1. Determined if the person attempting entry was a pedestrian or was in a vehicle.	___	___
2. Performed a visual check of the exterior front of the vehicle as it approached.	___	___
3. Stopped the vehicle by using hand-and-arm signals.	___	___
4. Identified the driver and vehicle occupants.	___	___
5. Determined if the vehicle and occupants were authorized access.	___	___
6. Granted or denied the vehicle and occupants access to the installation by using a verbal command and/or hand-and-arm signals.	___	___
7. Performed a visual check of the person approaching the pedestrian gate.	___	___
8. Stopped the person by using a verbal command and/or hand-and-arm signals.	___	___
9. Identified each person and asked what they were carrying if anything.	___	___
10. Granted or denied the person access to the installation by using a verbal command or hand-and-arm signals.	___	___
<p>a. Directed them to the access control operations center if the person could not produce an authorize form of a state or federal government-issued photo ID card, to be checked against the barred persons list, to be vouched for by an authorized person on the installation, or to be denied access to the installation.</p>	___	___
<p>b. Denied the person access to the installation if they did not have proper ID.</p>	___	___
<p>c. Notified the supervisor of any problems or suspicious activity.</p>	___	___

**Evaluation Guidance:** Refer to chapter 1, paragraph 1-9e, (1) and (2).

**References**

**Required:**

**Related:** AR 190-13



---

## 551-721-1359

### Operate a Vehicle in a Convoy

**Conditions:** As a vehicle operator in a contemporary operating environment (COE), threat environment, given a convoy briefing by the convoy commander, a mission-ready tactical wheeled vehicle, load-bearing vest (LBV), with Kevlar®, protective mask, and hearing protection. Vehicles have not been marshaled into order of march for convoy.

Task must be performed under the march unit commander's supervision.

**Special Conditions:** Convoy is operating in a COE tactical environment. Defensive preparation are applicable. "Mission-ready vehicle" is defined as a vehicle that has been hardened as appropriate, has all preventive maintenance checks completed and is in operational condition. This includes any installed communications or navigation equipment. and armaments (as applicable). If the convoy column is not divided into serial/march units the convoy commander will be issuing authority for all commands.

**Standards:** Operate the vehicle according to specific instructions from the convoy or serial/march unit commander. Exercise heightened situational awareness by performing required scanning procedures to detect enemy threats to convoy during convoy movement. Correctly maintain established convoy interval, speed, and vehicle position within the convoy. Perform all at-halt checks. Correctly react to and relay any hand-and-arm signals used during the convoy. Perform all requirements without injury to Soldiers or damage to the equipment.

---

#### Performance Steps

1. In the staging area, move the vehicle into position in according to the convoy order of march.
    - a. Refer to the vehicle TM for starting procedures.
    - b. Follow the ground guide to maneuver vehicle into position.
    - c. Shutdown vehicle per the TM (unless told otherwise).
  2. Conduct convoy predeparture checks.
    - a. Conduct a communications check (if so equipped).
    - b. Identify by bumper number, the vehicles immediately ahead of and behind your vehicle in the convoy column.
    - c. Check load security. Adjust tiedown devices as needed.
    - d. Check security of all stowage compartments.
    - e. Conduct sensitive items check. (Convoy commander or tactical standing operating procedure [TACSOP] may dictate specific items).
    - f. Ensure that the assigned weapon is loaded/unloaded according to the SOP or convoy commander's guidance.
  3. Start the vehicle on signal or order from convoy commander/serial/march unit commander.
-

## Performance Steps

4. Set the vehicle in motion upon signal or order from the convoy commander/serial/march unit commander.
  5. Maintain the convoy speed and vehicle interval during movement.
    - a. Maintain visual contact with the vehicle immediately in front of and behind your vehicle (if weather permits)
    - b. Track the vehicle in front and the trailing vehicles to adjust your speed, interval and position.
  6. Maintain a high state of situational awareness.
    - a. Perform side-to-side scanning (9 to 3 o'clock without an assistant driver)
    - b. Perform side-to-side scanning (9 to 1 o'clock with an assistant driver)
    - c. Watch for threats to the convoy such as—
      - (1) Suspicious individuals or groups along the roadway.
      - (2) Unexploded improvised explosive devices (IEDs).
      - (3) Abandoned vehicles along the roadway.
      - (4) Dead animals along the roadway.
      - (5) Overpasses over the route of march.
      - (6) Built-up areas, especially multistory buildings close to the roadway.
      - (7) Intersections.
  7. Acknowledge hand-and-arm signals by adjusting vehicle speed, interval, and position during movement.
    - a. Refer to the vehicle TM.
    - b. Relay hand-and-arm signals to the trailing vehicle drivers.
  8. During halt, position the vehicle as directed.
  9. During halt, shutdown the vehicle (unless told otherwise for the mission).
    - a. Refer to the vehicle TM for proper shutdown procedures.
    - b. Chock the vehicle wheels as necessary.
  10. During halt, perform during-operation maintenance checks on the vehicle and trailer (if so equipped).
    - a. Record any uncorrectable faults.
    - b. Notify the convoy chain of command if the vehicle becomes not-mission-capable (NMC).
  11. As directed, move the vehicle into the assembly area.
-

**Performance Steps**

- a. Follow the ground guide into the assembly area (if guide is available)/.
  - b. Follow the lead vehicle into the assembly area (as directed if the guide is not available).
12. Perform after-operation preventive maintenance checks.
- a. Refer to the vehicle TM for proper procedures.
  - b. Follow additional guidance from the supervisor or serial/march unit commander.

**Evaluation Preparation:** *Setup:* Set up the convoy with six vehicles at the starting point. Select a route for the convoy, which will not interfere with the regular traffic. Use a noncommissioned officer (NCO) trained in convoy procedures to act as the convoy commander. Have the convoy commander brief the Soldier on convoy operations.

*Brief Soldier:* Tell the Soldier to follow the instructions given in the convoy commander's briefing.

Performance Measures	GO	NO GO
1. Moved the vehicle into position in according to the convoy order of march.	_____	_____
2. Conducted final predeparture checks.	_____	_____
3. Started the vehicle on signal or order from the serial/march unit or convoy commander.	_____	_____
4. Set the vehicle in motion upon signal or order from serial/march unit or convoy commander.	_____	_____
5. Maintained convoy speed and interval during movement.	_____	_____
6. Maintained a high state of situational awareness during movement.	_____	_____
7. Acknowledged hand-and-arm signals by adjusting vehicle speed, interval, and position.	_____	_____
8. During halt, positioned the vehicle as directed.	_____	_____
9. During halt, shutdown the vehicle (unless told to do otherwise).	_____	_____
10. During halt, performed all during-operation maintenance checks on the vehicle and trailer.	_____	_____
11. During halt, checked security and condition of load (if loaded).	_____	_____
a. Checked tiedown devices for security.	_____	_____

Performance Measures	GO	NO GO
b. Ensured that the load had not shifted during movement.		
c. Notified the convoy chain of command if the load was damaged during movement.		
d. Accounted for sensitive items prior to halt area departure.		
12. Resumed convoy movement on signal or order from the convoy commander. (Repeated steps 1 through 7.)	___	___
13. As directed, moved the vehicle into the assembly area.	___	___
14. Shut down the vehicle at the destination (unless told otherwise)	___	___
15. Performed after-operation maintenance checks.	___	___
a. Referred to the TM.		
b. Turned in the vehicle dispatch, maintenance worksheets, and load documentation as required to the supervisor or convoy chain of command.		

**Evaluation Guidance:** Refer to chapter 1, paragraph 1-9e, (1) and (2).

### References

**Required:** FM 21-305

**Related:** FM 55-15, FM 55-30, TM 9-2320-260-10, TM 9-2320-272-10, TM 9-2320-279-10-1, TM 9-2320-279-10-2, TM 9-2320-280-10, TM 9-2320-283-10, TM 9-2320-303-10, TM 9-2320-360-10, TM 9-2320-364-10, TM 9-2320-365-10, TM 9-2320-365-10, TM 9-2320-366-10-1, TM 9-2320-366-10-2, TM 9-2320-392-10-1, TM 9-2320-392-10-1, TM 9-2320-392-10-2, and TM 9-2330-385-14

## SUBJECT AREA 5: NAVIGATE

### 061-283-1001

#### Determine Direction Within the Target Area

**Conditions:** Given an object in the target area with a known direction, field artillery binoculars, a compass, and a target in the target area.

**Standards:** Determine the direction to selected points expressed to the nearest 10 mils (60 mils) of the actual direction.

#### Performance Steps

1. Identify five methods of determining direction within the target area.

**Note:** Determining direction is an essential skill for the observer. Direction is an integral part of terrain-map association, adjustment of fire, and target location.

## Performance Steps

- a. Estimating. As a minimum, the observer should be able to visualize the eight cardinal directions (N, NE, E, SE, S, SW, W, NW). Because of the accuracy of this method, it is the least preferred method to determine direction.
- b. Scaling from a map. Using a protractor, the observer can scale direction from a map to an accuracy of 10 mils.
- c. Using a compass: The observer can measure direction to an accuracy of 10 mils using a M2 or a lensatic compass.
  - (1) Be careful when using a compass around radios or large concentrations of metal such as vehicles.
  - (2) Maintain a minimum of 50 meters distance from large metal objects to avoid incorrect readings.
- d. Measuring from a reference point: Measure horizontal angular deviations and apply them to the reference directions using a reference point with a known direction.
  - (1) Know how to measure angular deviations with the binoculars or with the hand. When measuring with binoculars, angular deviation must be determined to the nearest 1 mil.
    - (a) The horizontal scale of the binocular reticle pattern is divided into increments of 10 mils.
    - (b) The vertical scale in the center of the lens is divided into increments of 10 mils and is used in HOB adjustments.
  - (2) Apply the right add/left subtract (RALS) rule and announce the new direction to the target.

*Note:* Ensure that the students understand how to apply RALS when determining target direction from a point of known direction.
  - (3) Express direction to the nearest 10 mils and within 60 mils of the actual direction.
    - (a) Use the RALS method of determining direction. Direction increases to the right and decreases to the left.
    - (b) To determine the direction to the target, apply the number of mils measured left or right of the known direction by applying RALS.
- e. Using other measuring devices. When properly oriented, the G/VLLD provides direction to the nearest mil.

---

**Evaluation Preparation:** *Setup:* Ensure that all the equipment is available, serviceable, and ready for use. Use the reference and the evaluation guide to score the Soldier's performance.

*Brief Soldier:* Tell the Soldier what he/she is required to do according to the task conditions and standards.

Performance Measures	GO	NO GO
1. Measured direction using one of the five methods.	___	___
2. Used the M2 compass and determined direction to two reference points within 60 mils of the actual direction.	___	___
3. Expressed direction to the nearest 10 mils.	___	___
4. Expressed direction to the nearest 10 mils and within 60 mils of the actual direction.	___	___

**Evaluation Guidance:** Refer to chapter 1, paragraph 1-9e, (1) and (2).

**References**

**Required:** FM 3-09.30 (6-30) and FM 3-25.26

**Related:**

## 071-329-1000

### Identify Topographic Symbols on a Military Map

**Conditions:** Given a standard 1:50,000-scale military map.

**Standards:** Identify topographic symbols, colors, and marginal information on a military map with 100 percent accuracy.

**Performance Steps**

1. Identify the colors on a military map (table 071-329-1000-1).

**Table 071-329-1000-1. Colors on topographic maps**

COLORS	SYMBOLS
Black	Cultural (man-made) features other than roads
Blue	Water
Brown	All relief features - contour lines on old maps - cultivated land on red-light readable maps
Green	Vegetation
Red	Major roads, built-up areas, special features on old maps
Red-brown	All relief features and main roads on red-light readable maps

*Note:* Ideally, every feature on the part of the earth mapped could be shown on the map in its true shape and size. Unfortunately, that is impossible. The amount of detail shown on a map increases or decreases depending on its scale, for example, a map with a scale of 1:250,000 would show a larger area than one with a scale of 1:50,000, but with far fewer details. Details are shown by topographic symbols. These symbols are shown using six basic colors as shown in table 071-329-1000-1.

**Performance Steps**

2. Identify the symbols on the map that represent physical features, such as physical surroundings or objects, as shown in table 071-329-1000-2.

**Table 071-329-1000-2. Features on topographic maps**

FEATURES	COLORS	DESCRIPTION
Drainage	Blue	These symbols include lakes, Streams, rivers, marshes, swamps, and coastal waters.
Relief	Brown	These features are normally shown by contour lines, intermediate contourlines, and form lines. In addition to contour lines, there are relief symbols to show cuts, levees, sand, sand dunes, ice fields, strip mines, and glaciers.
Vegetation	Green	These symbols include woods, shrub, orchards, vineyards, tropical grass, mangrove and marshy areas, or tundra.
Roads	Red, Black, or Red-brown	These symbols show hard-surface, heavy-duty roads; hard surface, medium-duty roads; Improved light-duty roads; unimproved dirt roads; and trails. On foreign road maps, symbols may differ slightly; check the map legend for proper identification of roads.
Railroads	Black	These symbols show single-track railroads in operation; single-track railroads not in operation; double- or multiple-track railroads.
Buildings	Black, Yellow, Red, or Pink	These symbols show built-up areas, schools, churches, ruins, lighthouses, windmills, and cemeteries.

a. Identify each object by its shape on the map. For example, a black, solid square represents a building or a house; a round or irregular blue item is a lake or pond.

b. Use logic and color to identify each map feature. For example, blue represents water. If you see a symbol that is blue and has clumps of grass, this would be a swamp.

c. The size of the symbol shows the relative size of the object. Most symbols are enlarged 6 to 10 times so that you can see them under dim light.

d. Use the legend, which should identify most of the symbols used on the map.

## Performance Steps

3. Identify the marginal information found in the legend.
  - a. Top of map sheet:
    - (1) Top left corner—the geographic location covered by the map and the scale of the map.
    - (2) Top center—the name of the map sheet.
    - (3) Top right corner—the map edition, the map series, and the map sheet number.
  - b. Bottom of map sheet:
    - (1) Lower left corner—the legend, the name of the agency that prepared the map, the map sheet number, and the map sheet name.
    - (2) Bottom center—the bar scales in meters, yards, miles, and nautical miles; the contour interval of the contour lines; the grid reference box; the declination diagram; and the G-M angle (mils or degrees).
    - (3) Lower right corner—the elevation guide, the adjoining map sheet diagram, and the boundaries box, which shows any boundaries that might be on the map.

**Evaluation Preparation:** *Setup:* On a 1:50,000-scale military map, circle each item of marginal information found on the map. Randomly letter the circled items A through J. Circle an item or feature shown on the map by color. Randomly number each colored item 1 through 10. The items are listed in the TIO. For each Soldier tested, provide a sheet of paper, two pencils, and a duplicate map.

*Brief Soldier:* Tell the Soldier to letter the paper A through J, and then 1 through 10. Tell the Soldier to write the name of the item contained in each lettered and numbered circle on the map.

Performance Measures	GO	NO GO
1. Identified the sheet name.	___	___
2. Identified the sheet number.	___	___
3. Identified the contour interval.	___	___
4. Identified the G-M angle (mils or degrees).	___	___
5. Identified the legend.	___	___
6. Identified the bar scales.	___	___
7. Identified the declination diagram.	___	___
8. Identified the grid reference box.	___	___
9. Identified the adjoining map sheets diagram.	___	___
10. Identified the elevation guide.	___	___
11. Identified 2 of 2 specific manmade features (shown in black on the map).	___	___
12. Identified 2 of 2 water features (blue on the map).	___	___



Performance Measures	GO	NO GO
13. Identified 2 of 2 vegetation features (green on the map).	_____	_____
14. Identified 2 of 2 manmade features, for example, main roads or built-up areas (brown or red-brown on the map).	_____	_____
15. Identified 2 of 2 contour lines (brown or red-brown on the map).	_____	_____

**Evaluation Guidance:** Refer to chapter 1, paragraph 1-9e, (1) and (2).

**References**

**Required:** FM 21-31 and FM 3-25.26

**Related:**

## 071-329-1001

### Identify Terrain Features on a Map

**Conditions:** Given a standard 1:50,000-scale military map.

**Standards:** Identify the five major and three minor features on the map.

**Performance Steps**

1. Identify terrain features in table 071-329-1001-01 the same way on all maps, regardless of the contour interval. Keep in mind that a hill in the Rocky Mountains will be much bigger than the one in South Florida. You must be able to recognize all the terrain features to locate a point on the ground or to navigate from one point to another (figures 071-329-1001-1 through 071-329-1001-10).

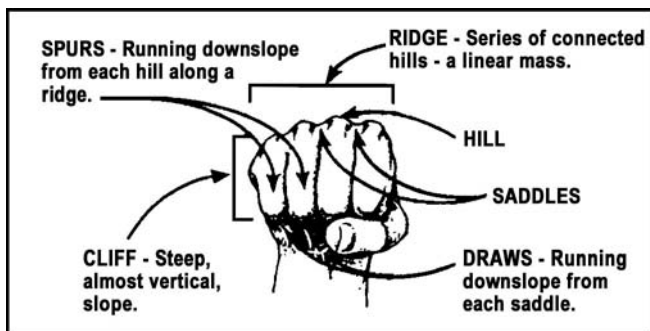

Figure 071-329-1001-1. Using a fist to explain terrain features

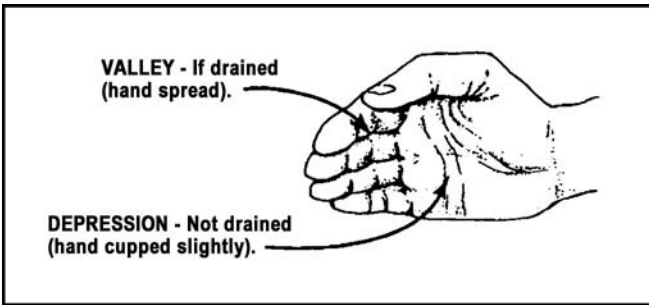

Figure 071-329-1001-2. Using a hand to explain terrain features

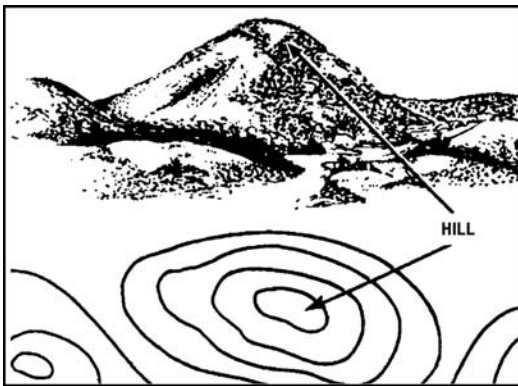

Figure 071-329-1001-3. A hill

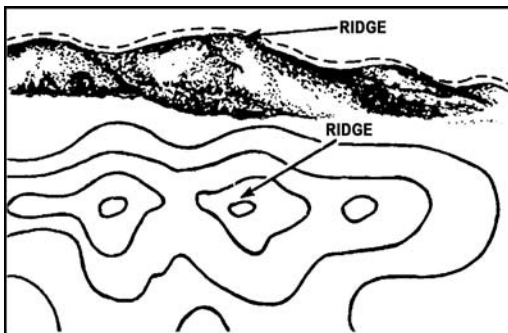

Figure 071-329-1001-4. A ridge

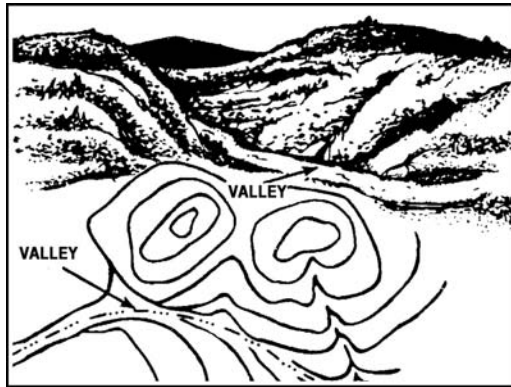

Figure 071-329-1001-5. A valley

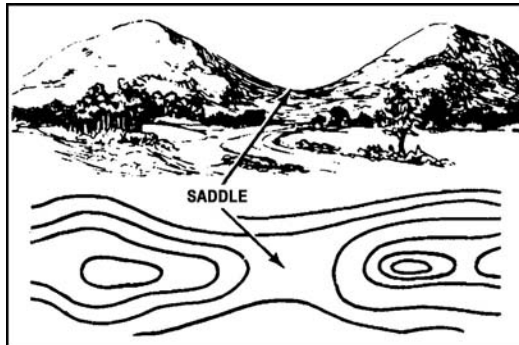

Figure 071-329-1001-6. A saddle

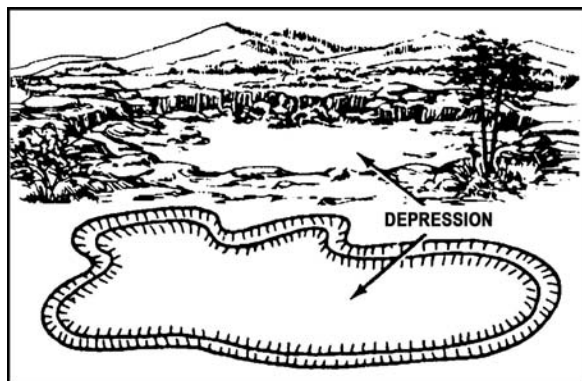

Figure 071-329-1001-7. A depression

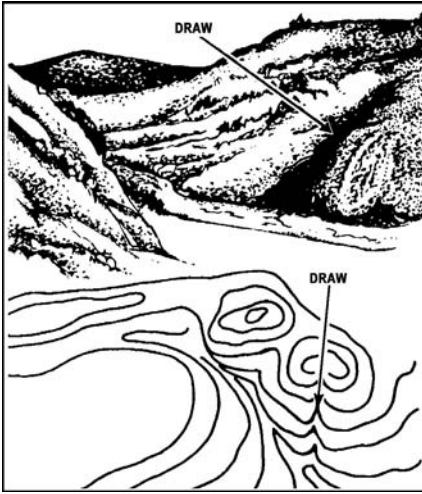

Figure 071-329-1001-8. A draw

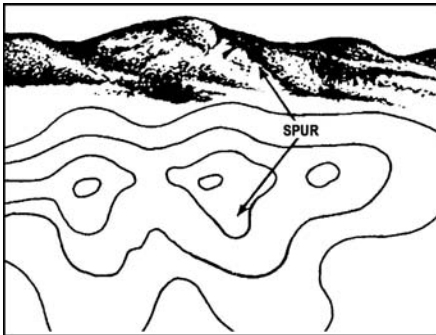

Figure 071-329-1001-9. A spur

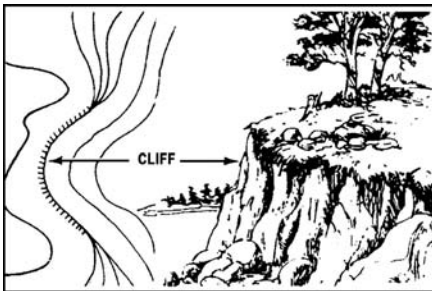

Figure 071-329-1001-10. A cliff

Table 071-329-1001-1. Major and minor terrain features

FEATURE	CHARACTERISTICS	MAP SYMBOL
<b>Hill</b> Figure 3 Major	A point or small area of high ground from which the ground slopes down in all directions.	Contour lines forming concentric circles.
<b>Ridge</b> Figure 4 Major	A line of high ground with height variations along its crest.	Contour lines forming a U or V; closed end points away from high ground.
<b>Valley</b> Figure 5 Major	Reasonably level ground bordered on the sides by higher ground. Generally has maneuver room. Contains a stream.	Contour lines form U. Lines tend to parallel stream before crossing. Contour line crossing a stream always points upstream.
<b>Saddle</b> Figure 6 Major	A dip/low point along a ridge crest; either lower ground between two hill tops or a break in the level crest.	A saddle is normally represented as an hourglass.
<b>Depression</b> Figure 7 Major	Low point or hole in the ground with higher ground on sides.	Closed contour lines that have tick marks pointing toward low ground.
<b>Draw</b> Figure 8 Minor	Like a valley, but normally has less developed stream course. No level ground and little or no maneuver room. Ground slopes upward on the sides and toward the head of the draw.	Contour lines are V-shaped with the point of the V toward the head of the draw (high ground).

Table 071-329-1001-1. Major and minor terrain features

FEATURE	CHARACTERISTICS	MAP SYMBOL
<b>Spur</b> Figure 9 Minor	Short, continuously sloping line of higher ground jutting out the side of a ridge. Often formed by parallel streams cutting draws down a ridge.	Contour lines depict a spur with the U or V pointing away from high ground.
<b>Cliff</b> Figure 10 Minor	A vertical or near vertical slope.	Contour lines are close together or a ticked or "carrying" contour line (ticks point to lower ground).

**Evaluation Preparation:** *Setup:* Use a 1:50,000-scale military map. Circle one example of each major terrain feature and one example of each minor terrain feature. Randomly number the circled terrain features 1 through 8. Provide each Soldier with duplicate sets of the map, paper, and two pencils.

*Brief Soldier:* Tell the Soldier to number the paper 1 through 8. Tell the Soldier to write down the terrain feature that corresponds to each circled area on the map.

During instruction, demonstrate to the Soldiers how they can learn terrain features using the fist and hand. Use these to show what each terrain feature would look like on the ground.

Performance Measures	GO	NO GO
1. Identified terrain features.	_____	_____

**Evaluation Guidance:** Refer to chapter 1, paragraph 1-9e, (1) and (2).

**References**

**Required:** FM 3-21.71

**Related:**

## 071-329-1002

### Determine the Grid Coordinates of a Point on a Military Map

**Conditions:** Given a standard 1:50,000-scale military map in a field location, a 1:50,000 grid coordinate scale, a pencil, paper, and a point on the map.

**Standards:** Determine the six-digit grid coordinates for the point on the map with a 100-meter tolerance. Record the grid coordinates with the correct two-letter 100,000-meter-square identifier.

Performance Steps
-------------------

*Note:* A military map can help you spot your location accurately. The map has vertical lines (top to bottom) and horizontal lines (left to right). These lines form small squares 1,000 meters on each side called grid squares.

*Note:* The lines that form grid squares are numbered along the outside edge of the map picture. No two grid squares will have the same number.

*Note:* The precision of a point location is shown by the number of digits in the coordinates; the more digits, the more precise the location. For example, "1996" is a 1,000-meter grid square; that is, it identifies a location to the nearest 1,000 meters. "192961" is a 100-meter grid square; that is, it identifies the location to the nearest 100 meters.

1. Look at figure 071-329-1002-1. Your address is grid square 1181. To determine your address, start from the left and read right until you come to 11, the first half of your address. Then read up to 81, the other half. Your address is somewhere in grid square 1181. Determine your address to the nearest 100 meters. Grid square 1181 gives your general neighborhood, but there is a lot of ground inside that grid square. To make your address more accurate, just add another number to the first half and another number to the other half so your address has six numbers instead of four.

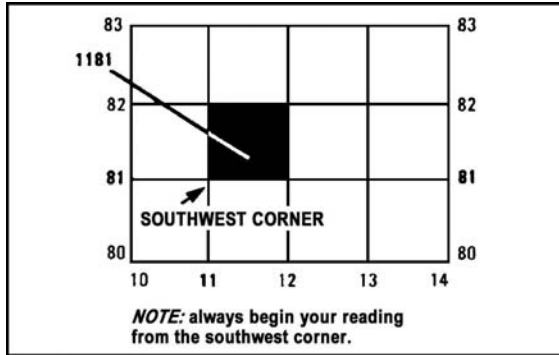

Figure 071-329-1002-1. Grid square 1181

a. To get these extra numbers, suppose that each grid square has 10 lines inside it running north and south, and another 10 running east and west. This makes 100 smaller squares. You can estimate where these imaginary lines are (figure 071-329-1002-2).

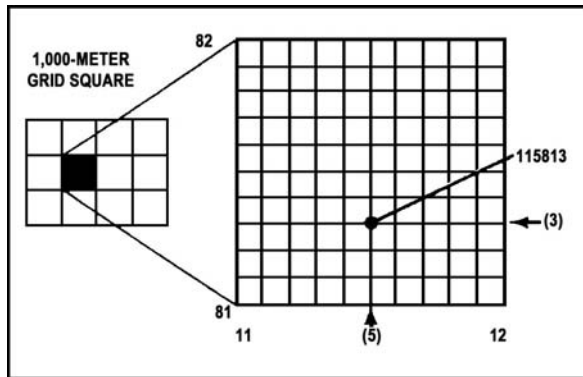

Figure 071-329-1002-2. Grid square 1181 divided

b. Suppose you are halfway between grid line 11 and grid line 12. Then the next number is 5 and the first half of your address is 115. Now suppose you are also  $\frac{3}{10}$  of the way between grid line 81 and grid line 82. Then the second half of your address is 813. Your address would be 115813 (figure 071-329-1002-2). (If you are exactly on line 81, the second half would be 810.)

2. Use a coordinate scale. The most accurate way to determine the coordinates of a point on a map is with a coordinate scale. You need not imagine lines because you can find the exact coordinates using the coordinate scale, protractor (GTA 5-2-12, figure 071-329-1002-3), or the plotting scale (figure 071-329-1002-4). Each device actually includes two coordinate scales, 1:25,000 and 1:50,000 meters. Make sure that, regardless which device you use, you choose the correct scale.

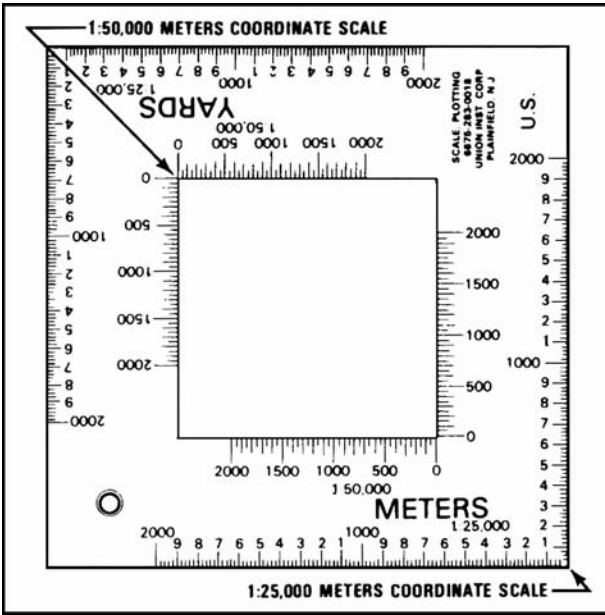

Figure 071-329-1002-3. Coordinate scale and protractor

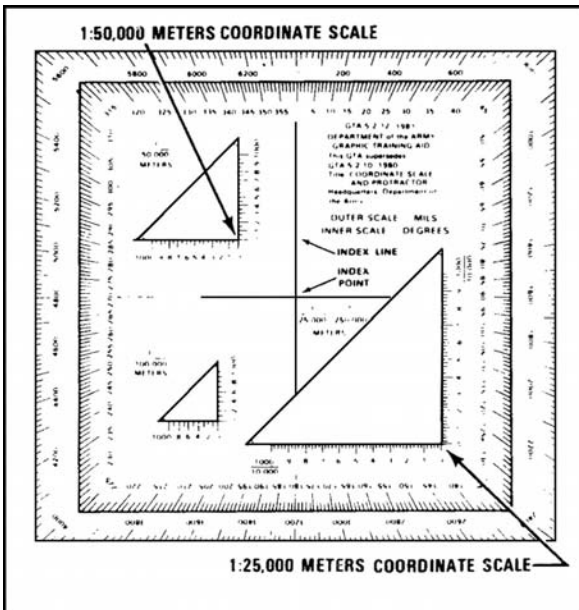
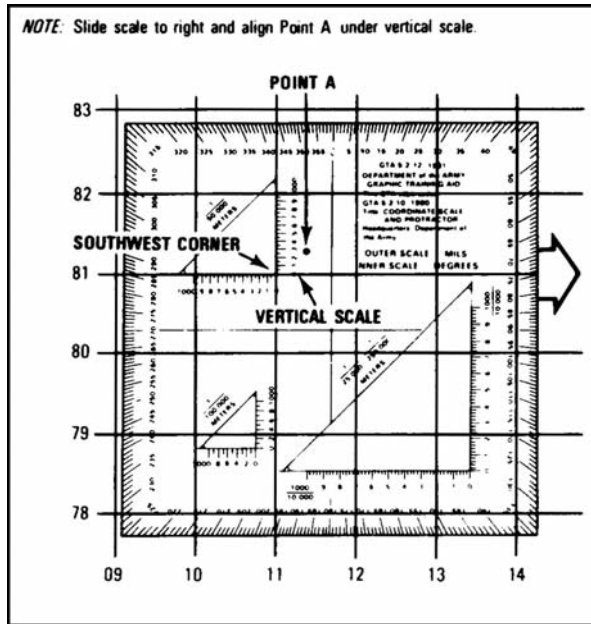

Figure 071-329-1002-4. Plotting scale

- a. Locate the grid square where the point is located; for example, point A. (figure 071-329-1002-5); this point should already be plotted on the map.





**Figure 071-329-1002-5. Placement of the coordinate scale**

- The number of the vertical grid line on the left (west) side of the grid square gives the first and second digits of the coordinate.
  - The number of the horizontal grid line on the bottom (south) side of the grid square gives the fourth and fifth digits of the coordinate.
- b.** Place a coordinate scale on the bottom horizontal grid line of the grid square containing point A to determine the third and sixth digits of the coordinate.
  - c.** Check to see that the zeros of the coordinate scale are in the lower left-hand (southwest) corner of the grid square where point A is located (figure 071-329-1002-5).
  - d.** Slide the scale to the right, keeping the bottom of the scale on the bottom grid line until point A is under the vertical (right-hand) scale (figure 071-329-1002-6 and figure 071-329-1002-7). To determine the six-digit coordinate, look at the 100-meter mark on the bottom scale, which is nearest the vertical grid line. This mark is the third digit of the number 115. The 100-meter mark on the vertical scale nearest to point A gives you the sixth digit of the number 813. Putting these together, you have 115813.

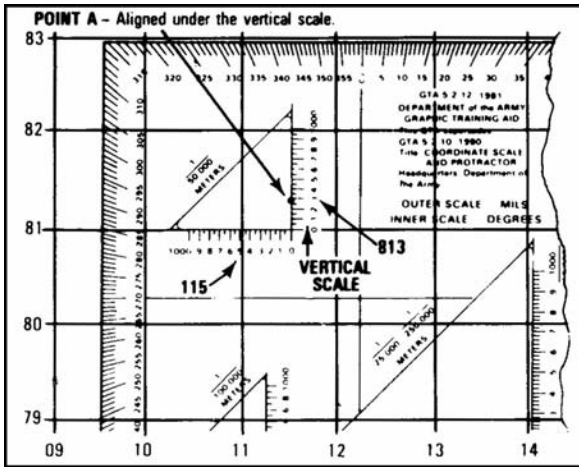

Figure 071-329-1002-6. Aligning the coordinate scale

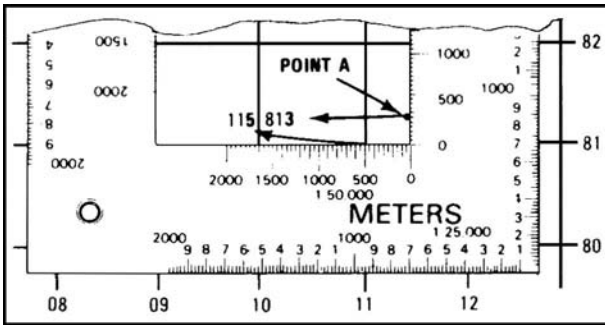

Figure 071-329-1002-7. Aligning the plotting scale

- e. To determine the correct two-letter 100,000-meter-square identifier, look at the grid reference box in the margin of the map (figure 071-329-1002-8).

Performance Steps



<p><b>SAMPLE 1,000-METER GRID SQUARE</b></p> 	<p><b>100-METER REFERENCE</b></p> <p>1. READ LARGE NUMBERS LABELING THE VERTICAL GRID LINE LEFT OF POINT AND ESTIMATE TENTHS (100 METERS) FROM GRID LINE TO POINT.</p> <p>2. READ LARGE NUMBERS LABELING THE HORIZONTAL GRID LINE BELOW POINT AND ESTIMATE TENTHS (100 METERS) FROM GRID LINE TO POINT.</p> <p><b>EXAMPLE: 123456</b></p>
<p><b>100,000-METER SQUARE IDENTIFICATION</b></p> 	<p>WHEN REPORTING ACROSS A 100,000-METER LINE, PREFIX THE 100,000-METER SQUARE IDENTIFICATION IN WHICH THE POINT LIES.</p> <p><b>EXAMPLE: FL123456</b></p>
<p><b>GRID ZONE DESIGNATION</b></p> <p><b>16S</b></p>	<p>WHEN REPORTING OUTSIDE THE GRID ZONE DESIGNATION AREA, PREFIX THE GRID ZONE DESIGNATION.</p> <p><b>EXAMPLE: 16SFL123456</b></p>

Figure 071-329-1002-8. Grid reference box

- f. Place the 100,000-meter-square identifier in front of the coordinate, GL115813.

**Evaluation Preparation:** *Setup:* Give the Soldier a standard 1:50,000-scale military map in a field location, a 1:50,000 grid coordinate scale, a pencil, paper, and a point on a map for which coordinates must be determined.

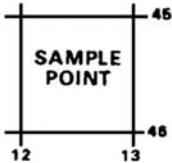
*Brief Soldier:* Tell the Soldier to write down the two-letter 100,000-meter-square identifier and the six-digit grid coordinates for one point, along with the two-letter 100,000-meter-square identifier.

Performance Measures	GO	NO GO
1. Determined the six-digit grid coordinates for the point on the map with a 100-meter tolerance.	_____	_____
2. Recorded the grid coordinates with the correct 2-letter 100,000-meter-square identifier.	_____	_____

**Evaluation Guidance:** Refer to chapter 1, paragraph 1-9e, (1) and (2).

**References**

**Required:** FM 3-25.26 and GTA 05-02-12

**Related:**

## 071-329-1003

### Determine a Magnetic Azimuth Using a Lensatic Compass

**Conditions:** Given a compass and a designated point on the ground.

**Standards:** Determine the correct magnetic azimuth to the designated point within 3 degrees using the compass-to-cheek method and within 10 degrees using the center-hold method.

#### Performance Steps

1. Read your compass (figure 071-329-1003-1).

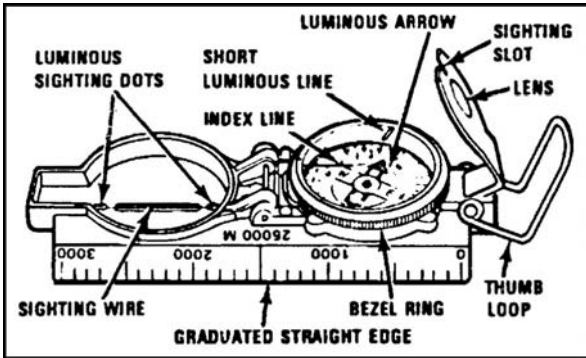

Figure 071-329-1003-1. Lensatic compass

- a. Use the floating dial to determine the direction in which you are pointing your compass.
- b. Use the outer, black ring of numbers and tick marks for finding direction in mils (figure 071-329-1003-2).

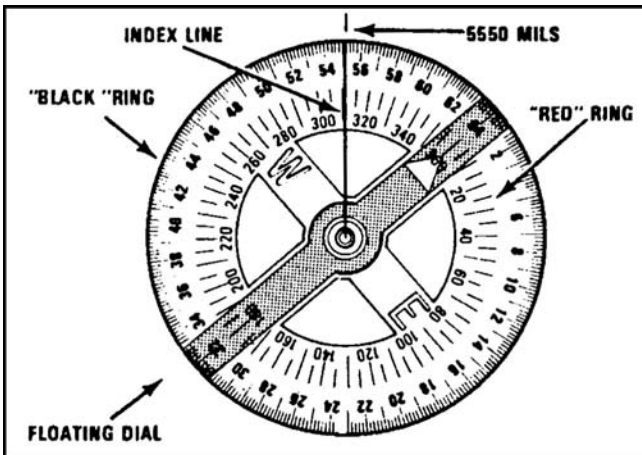

Figure 071-329-1003-2. Lensatic compass floating dial

## Performance Steps

**c.** Use the inner red ring of numbers and tick marks for finding direction in degrees.

**(1)** There are 360 degrees or 6400 mils in a circle. These are marked with a tick mark every 5 degrees or 20 mils. However, not every tick mark is numbered. You will have to determine the number for these lines using the numbers that are shown.

**(a)** To read direction, point the compass in the direction you want to go or want to determine.

**(b)** Look beneath the index line on the outer glass cover and estimate to the nearest degree or 10 mils the position of the index line over the red or black scale.

**(c)** Be careful to hold the compass still so that the dial remains stationary while you are reading the scale.

**(2)** If you understand these readings and can apply either of the holding and sighting techniques of shooting an azimuth, you will be proficient in performing this task.

**2.** Shoot an azimuth.

**a.** Use your compass to determine or follow an azimuth. The arrow on the compass points toward magnetic north. The arrow is also attracted by any mass of metal; for example, a truck, your rifle, your helmet, and even electrical power lines. Thus, be sure you use your compass away from metal objects, so it will not give a wrong reading.

**b.** Always hold the lensatic compass level and firm when sighting on an object and reading an azimuth.

**c.** There are two methods of holding the lensatic compass and sighting.

**(1)** Compass-to-cheek method (figure 071-329-1003-3). To use this method—

**(a)** Open the cover to a 90-degree angle to the base. Position the eyepiece at a 45-degree angle to the base.

**(b)** Place your thumb through the thumb loop, form a steady base with your third and fourth fingers, and extend your index finger along the side of the compass base.

---

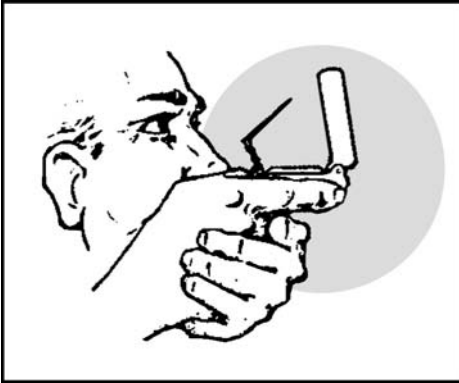

**Figure 071-329-1003-3. Compass-to-cheek method**

- (c) Place the hand holding the compass into the palm of the other hand.
  - (d) Bring both hands up to your face and position the thumb that is through the thumb loop against the cheekbone.
  - (e) Look through the lens of the eyepiece. If the dial is not in focus, move the eyepiece up or down until the dial is in focus.
  - (f) Align the sighting slot of the eyepiece with the sighting wire in the cover on the point for which the azimuth is being determined. Look through the lens of the eyepiece and read the azimuth under the index line.
- (2) Center-hold method (figure 071-329-1003-4). Use this method only when you do not need a precise direction:

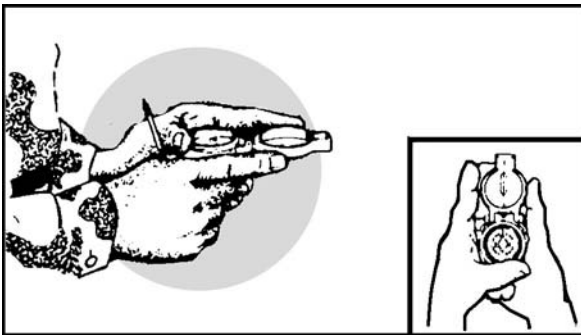

**Figure 071-329-1003-4. Center-hold method**

- (a) Open the compass so that the cover forms a straight edge with the base. The lens of the compass is moved out of the way.
- (b) Next, place your thumb through the loop, form a steady base with your third and fourth fingers, and extend your index finger along the side of the compass.

## Performance Steps

(c) Place the thumb of the other hand between the eyepiece and lens, extend the index finger along the remaining side of the compass, wrap the remaining fingers around the fingers of the other hand, and pull your elbows firmly into your side. This will place the compass between your chin and your belt.

(d) To measure an azimuth, turn your entire body toward the object and point the compass cover directly at the object. Look down and read the azimuth from beneath the fixed black index line. This method can be used at night.

(e) To keep from going in circles when you are land navigating, stop occasionally to check the azimuth along which you are moving. Also, you can move from object to object along your path by shooting an azimuth to each object and then moving to that object. Repeating this process while you navigate should keep you straight.

**Evaluation Preparation:** *Setup:* Select a point to use as a target and determine the azimuth to the point using the compass that the Soldier will use.

*Brief Soldier:* Point out the selected spot to the Soldier. Tell the Soldier to shoot an azimuth to that spot using both the compass-to-cheek method and the center-hold method.

Performance Measures	GO	NO GO
1. Determined the correct magnetic azimuth to the designated point within 3 degrees using the compass-to-cheek method.	___	___
2. Determined the correct magnetic azimuth to the designated point within 10 degrees using the center-hold method.	___	___

**Evaluation Guidance:** Refer to chapter 1, paragraph 1-9e, (1) and (2).

### References

**Required:** FM 3-25.26

**Related:**

## 071-329-1004

### Determine the Elevation of a Point on the Ground Using a Map

**Conditions:** Given a standard 1:50,000 scale military map, a pencil, and a designated point on the map.

**Standards:** Determine the elevation of the designated point to within half the value of the contour interval.

## Performance Steps

### 1. Locate contour lines and contour intervals.

a. The brown lines on the map are called contour lines. Each line shows the height above sea level. Contour lines never cross one another. Printed at the bottom of the map is the contour interval, which is the difference in height (elevation) between one brown line and the one on either side of it. On a map with a scale of 1:50,000, the contour interval is usually 20 meters. This would make point A 80 meters higher or lower than point B (figure 071-329-1004-1).

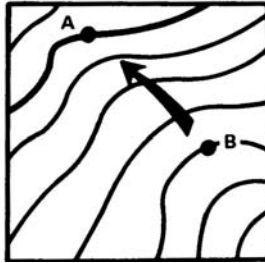

Figure 071-329-1004-1. Contour lines

b. You can easily tell from the brown lines the direction of uphill or downhill because every fifth line is heavier and has a number that gives its elevation. Suppose the contour interval is 20 meters. Now you can tell that point B is 80 meters lower in elevation than point A. Also, if you know the distance between A and B, you can get an idea of the steepness of the slope (figure 071-329-1004-2).

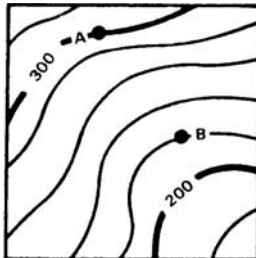

Figure 071-329-1004-2. Contour intervals

c. Widely spaced contour lines show a gentle slope. Close lines indicate a steep slope (figure 071-329-1004-3).

---



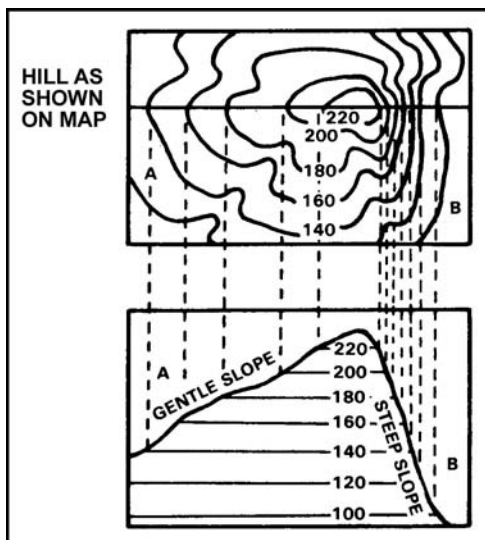

Figure 071-329-1004-3. Slope

- d. Widely spaced contour lines at the top of a hill show a flat hilltop. Close lines indicate a pointed hill (figure 071-329-1004-4).

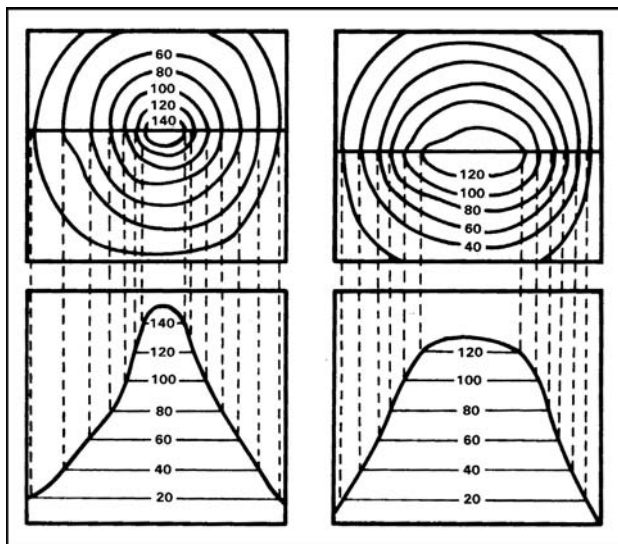

Figure 071-329-1004-4. Elevation

2. Determine elevation.

## Performance Steps

- a. Locate the point on the map. (It may already be plotted on the map or given as an eight-digit coordinate).
- b. Determine the contour interval of the map from the marginal information.
- c. Locate the index contour line nearest the point for which the elevation is being sought.
- d. Count the number of contour lines, up or down, that must be crossed to go from the numbered lines to the point, and note the direction to the point. If the point is on a contour line, its elevation is that of the contour line. For points between contour lines—
  - (1) Points less than one-fourth of the distance between lines are considered to be the same as the elevation of the nearest line.
  - (2) Points one-fourth to three-fourths of the distance from the lower line are considered to be at an elevation half the contour interval above the lower line.
- e. To estimate the elevation of the top of an unmarked hill, add half the contour interval to the elevation of the highest contour line around the hill.
- f. To estimate the elevation of the bottom of the depression, subtract half the contour interval from the elevation of the lowest contour around the depression.
- g. On maps that do not show elevation and relief in as much detail as is needed, use supplementary contour lines. Marginal information indicates the interval. Use the supplementary lines exactly as you would use solid contour lines.

**Evaluation Preparation:** *Setup:* Provide the Soldier with a 1:50,000 scale military map, a designated point on the map labeled "A," and a pencil.

*Brief Soldier:* Tell the Soldier to determine the elevation of the point that is labeled "A" on the map.

Performance Measures	GO	NO GO
1. Determined the correct elevation within half the value of the contour interval.	_____	_____
<i>Note:</i> If the contour interval of the map is in feet, the answer must be in feet. If the contour interval is in meters, the answer must be in meters.		

**Evaluation Guidance:** Refer to chapter 1, paragraph 1-9e, (1) and (2).

### References

**Required:** FM 3-25.26

**Related:**

---

## 071-329-1005

### Determine a Location on the Ground by Terrain Association

**Conditions:** In the field during daylight, while at an unknown location on the ground, given a standard 1:50,000-scale military map of the area, pencil, paper, a coordinate scale and protractor, and a known point on the ground.

**Standards:** Within 7 minutes, determine the six-digit coordinate of your location with a 100-meter tolerance.

#### Performance Steps

1. Determine the type of terrain feature you are located on.
2. Determine what types of terrain features surround your location.
3. Orient the map.
4. Determine the four cardinal directions (North, South, East, and West).
5. Determine your location.
  - a. Relate the terrain features on the ground to those shown on the map.
  - b. After you have determined where the terrain features on the ground and those on the map coincide, determine the coordinates of your location using the coordinate scale and protractor.

**Evaluation Preparation:** *Setup:* Select a field site whose terrain features are shown on the map. At the test site, provide a field table, a 1:50,000-scale military map of the area, pencil, paper, and a coordinate scale.

*Brief Soldier:* Tell the Soldier that he/she must determine a six-digit coordinate of his/her location within 7 minutes. Tell the Soldier one of the cardinal directions (North, South, East, or West).

Performance Measures	GO	NO GO
1. Identified the type of terrain feature where you are located.	_____	_____
2. Identified the terrain features around your location.	_____	_____
3. Oriented the map.	_____	_____
4. Determined the remaining three cardinal directions.	_____	_____
5. Identified the same terrain features on the map.	_____	_____
6. Determined the six-digit grid coordinate of your own location (the point selected must be within 100 meters of your location).	_____	_____

**Evaluation Guidance:** Refer to chapter 1, paragraph 1-9e, (1) and (2).

#### References

**Required:** FM 3-25.26

**Related:**

---

## 071-329-1006

### Navigate from One Point on the Ground to Another Point While Dismounted

**Conditions:** Given a standard topographic map of the area, scale 1:50,000, a coordinate scale and protractor, a compass, and writing materials.

**Standards:** Move on foot to designated points at a rate of 3,000 meters per hour.

#### Performance Steps

1. Determine your pace count.

a. When you have to go a certain distance on foot, you can measure distance by counting your paces. The average Soldier traveling uses 116 paces to travel 100 meters. Check your pace length by practicing on a known 100-meter distance, like a football field plus one end zone, which totals 110 yards (about 100 meters).

b. When you travel cross-country as you do in the field, you use more paces to travel 100 meters, usually about 148 instead of 116. This is because you are traveling over uneven ground and must use more paces to make up for your movement up and down hills. You should check your pace over at least 600 meters of crisscrossing terrain to learn how many paces it takes you to travel an average 100 meters over such terrain.

c. Be sure you know how many paces it takes you to walk 100 meters on both level and crisscrossing terrain.

(1) The challenge in pacing is to maintain a straight line. At night, people tend to walk in a clockwise circle unless they use compasses. In daylight, you should use aiming points and a compass. Also, remember to figure only the straight-line distance when you have to walk around an obstacle.

(2) Another challenge is keeping count of paces taken. One way is to use pebbles. For instance, suppose you want to pace off 1 kilometer. (A kilometer is 1,000 meters or the distance between two of the black grid lines on your map.) Put 10 pebbles in your right pocket. When you go 100 meters, move one pebble to your left pocket and start your count over. When all 10 pebbles had been moved to your left pocket, you have traveled 1 kilometer. Or, you can tie knots in a string, one knot per 100 meters.

d. Sample problem: You are to move 715 meters. Your pace count for 100 meters is 116 paces.

(1) Using the pebble method, you need seven pebbles to mark the 700 meters. But how many paces will you need to cover the other 15 meters?

(2) To determine this, multiply 15 meters by your pace count (116), that is,  $15 \times 116 = 1,740$ . Mark out the last two numbers (40). The remaining digits, 17, indicate the number of paces you will need to go 15 meters.

(3) So you would go 715 meters using the pebble method by pacing off 116 paces per 100 meters until all seven pebbles are used, then go an additional 17 paces to arrive at 715 meters.

---

## Performance Steps

2. Navigate from one point to another using terrain association. This technique uses terrain or manmade features as landmarks or checkpoints to maintain the direction of movement. Use this technique anywhere, day or night, as long as the terrain has distinguishable features. You use terrain association when moving from the unit area to the motor pool. You walk down the road or sidewalk using intersections or buildings to steer or turn on (landmarks or checkpoints). In the field, where you might have no roads or buildings, you use terrain features for your axis and checkpoints.

a. Locate your position on the map, and then locate your destination or objective. A straight line between the two is seldom the best way to travel. For example, look at figure 071-329-1006-1. Assume that you are to move from A to B. Notice that traveling a straight line between them might take you through several ridges and valleys (the "Xs" on figure 071-329-1006-1).

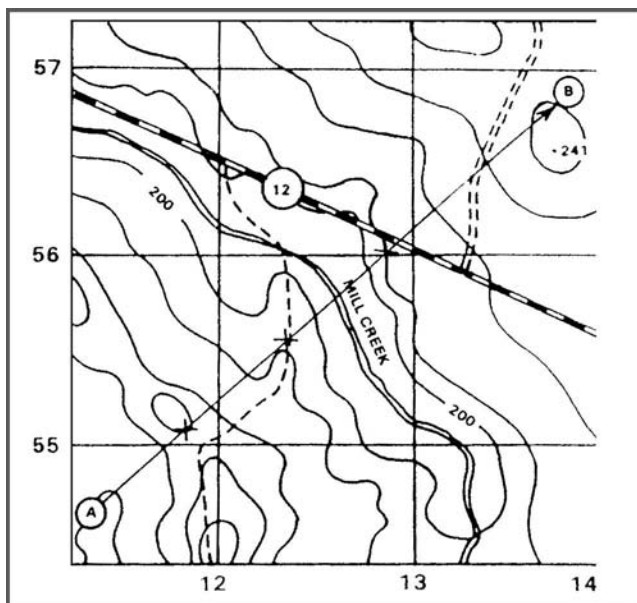

Figure 071-329-1006-1. Straight-line route

b. When adjusting your route, consider the following:

(1) Tactical aspect. Avoid skylining open areas and danger areas like streams or crossings on roads and hilltops. Your tactical concern is survival. The mission is causing you to move to your objective. You need to be sure you get to that objective. Looking at figure 071-329-1006-2, you decide for tactical reasons to cross the stream where you would not be seen from the road (C) and to cross the road in a small valley (D). You know that valleys offer better cover and concealment, so you will use them (E and F).

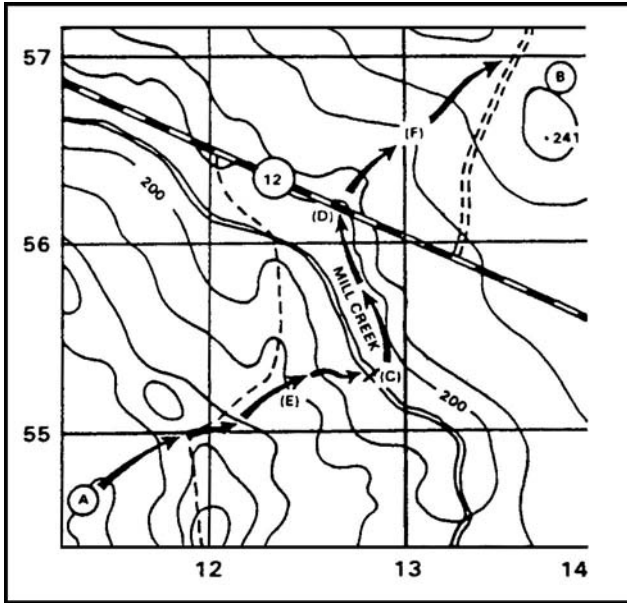

Figure 071-329-1006-2. Adjusted route

(2) Ease of movement. Always pick the easiest route that the tactical situation will allow. You achieve surprise by doing the unexpected. However, a difficult route increases your chance of getting lost. Also, traveling a difficult route might be noisy and can tire you out before you reach your objective.

(3) Boundaries. Traveling in a straight line is almost impossible, with or without a compass. Pick an axis or corridor. Pick boundaries that you can spot or feel. Hardtop roads, streams, high grounds, and railroads all make good boundaries. This way, if you start to wander too far off course, you will know it.

c. Suppose you decide that the route in figure 071-329-1006-3 offers ease of movement. Check your axis up the valley (1, figure 071-329-1006-3); across the ridge at the saddle (2, figure 071-329-1006-3); cross the stream, turn left and keep the stream on the left, high ground on the right (4, figure 071-329-1006-3); to the third valley (5, figure 071-329-1006-3); to the saddle, then on the objective (6, figure 071-329-1006-3).

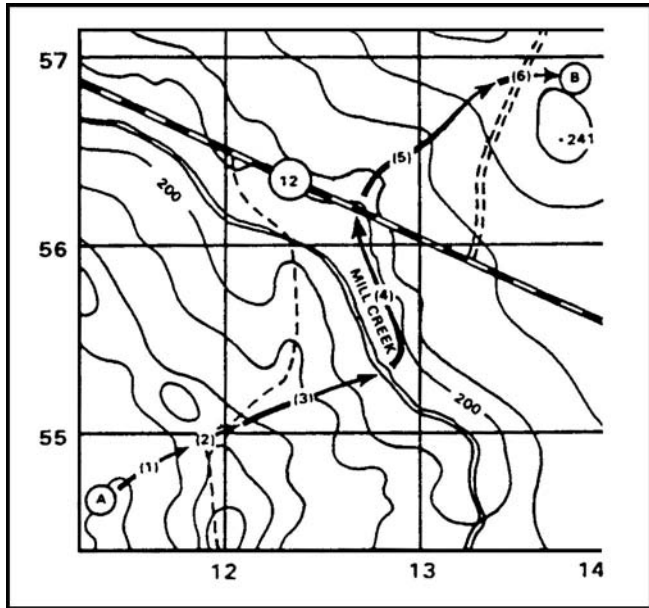

Figure 071-329-1006-3. Route of travel

d. With boundaries to keep you straight, you need to know where on your corridor you are located. Use checkpoints to do this. The best checkpoint is a line or linear feature that you cannot miss because you must cross a linear feature across your corridor or axis no matter where you are in the axis. Use hardtop roads, railroads, power lines, perennial streams (solid blue lines; the dashed blue lines indicate streams that are frequently dry), rivers, ridges, and valleys.

*Note:* Do NOT use light-duty roads and trails because a map never shows everything on the ground. DO NOT use wood lines, either, because they are rarely permanent.

e. Refer to figure 071-329-1006-03 and pick your checkpoints.

- (1) The saddle—use Hill 241 to line on up the right valley, which you will follow to—
- (2) The stream, which you will move alongside it until—
- (3) The bend in the stream, when you turn right to—
- (4) The road in the valley (the ridge crossing on the road on the 12 grid line will serve as a limiting feature), then up to—
- (5) The far saddle, and right to your objective (B).

f. If you cannot find linear features, use an elevation change—a hill or depression, a small ridge, or a valley. Look for one contour line of change during the day, two at night. Regardless of contour interval, you will spot a contour interval of change on foot.

## Performance Steps

g. Determine the distance between checkpoints. **DISTANCE IS THE CAUSE FOR MOST NAVIGATIONAL MISTAKES.** Estimate or measure the distance from one checkpoint to another, then trust that distance.

h. Refer to figure 071-329-1006-4 and check your distances:

- (1) 500 meters to the saddle (1).
- (2) 800 meters to the stream (2).
- (3) 500 meters to the bend in the stream (3).
- (4) 300 meters to the road (4).
- (5) 1,000 meters to the far saddle (5).

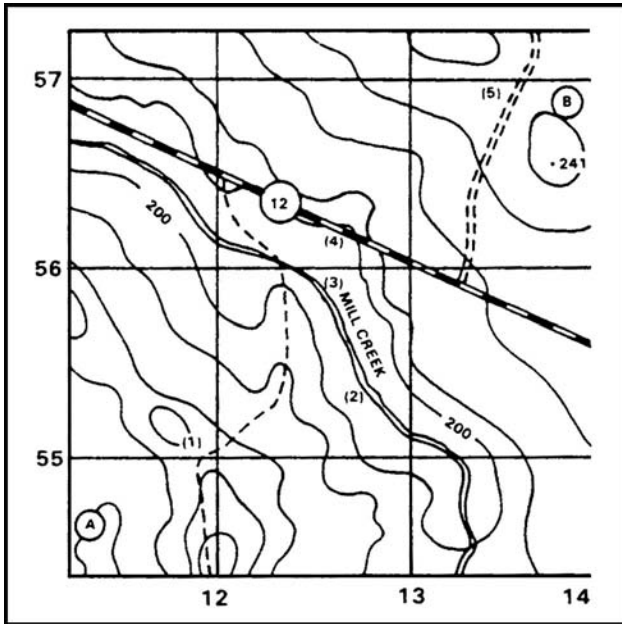

Figure 071-329-1006-4. Checkpoints

3. Navigate from one point to another using dead reckoning.

a. Dead reckoning is a technique of following a set route or line for a determined distance. Use this technique on flat terrain such as deserts and swamps. You can use this technique day or night. To use dead reckoning—

- (1) Locate the start and finish points on the map (figure 071-329-1006-5).



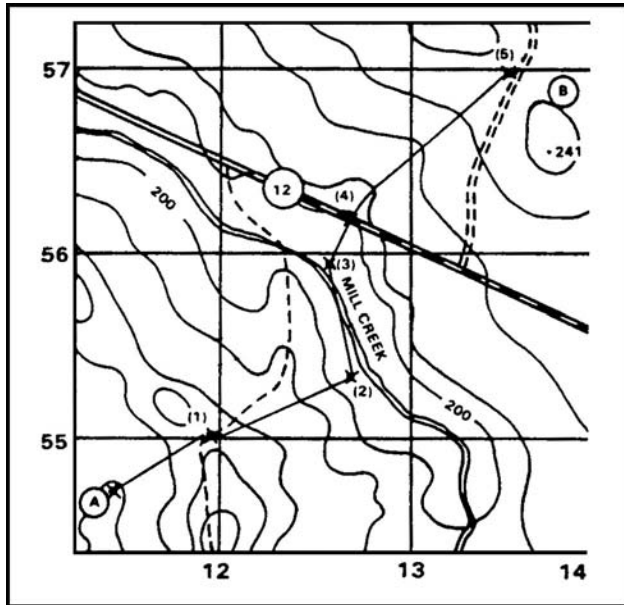

Figure 071-329-1006-5. Distance between checkpoints

(2) Determine the grid azimuth from the start point to the finish point or to the first intermediate point on the map.

(3) Convert the grid azimuth taken from the map to a magnetic azimuth.

(4) Determine the distance between the start and finish points or between any intermediate points on the map.

*Note:* If you do not know how many paces you take for each 100 meters, you should move to a 100-meter course and determine your pace count.

(5) Convert the map distance to pace count.

(6) Make a thorough map reconnaissance of the area between the start point and the finish point.

**b.** Before moving from the start point, shoot an azimuth on a well defined object on the ground in the direction of travel. These objects, known as steering points, may be lone trees, buildings, rocks, or any easily identifiable point. At night, the most likely steering point will be a star. Due to the rotation of the earth, the positions of the stars continually change. You must check your azimuth frequently, but only when halted. Using your compass while you are moving will cause you to go off-course. Your steering mark might be beyond your objective. Remember to travel the distance you determined.

**c.** Once you have selected a steering point, you should move toward it, remembering to begin your count. For every 100 meters you travel, you should have some method of tracking the number of 100 meters you travel.

## Performance Steps

- d. Upon reaching your first steering point, shoot an azimuth to another steering mark, and repeat step c until you reach the finish point.
- e. If you should encounter an obstacle, you might have to detour around it (figure 071-329-1006-6). To do this, complete a series of 90-degree turns until you bypass the obstacle and return to your original azimuth.

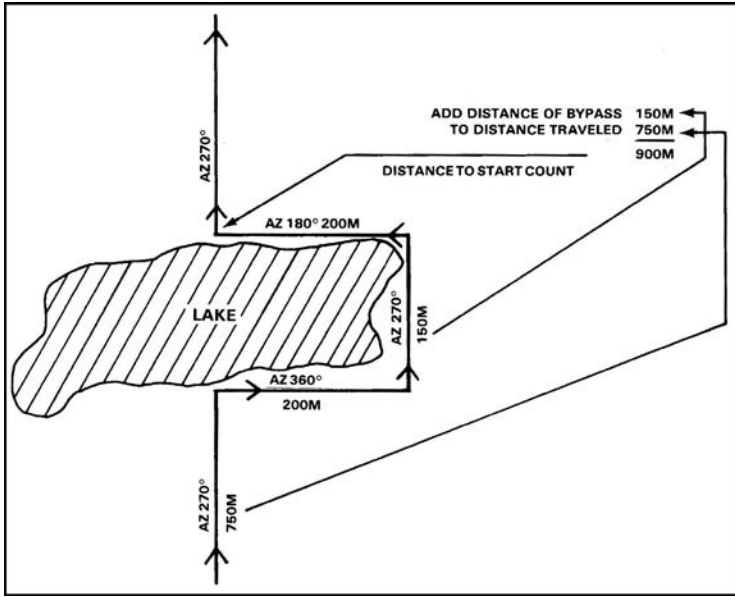

Figure 071-329-1006-6. Bypassing an obstacle

- (1) At the edge of the obstacle, make a note of the number of paces taken to this point.
- (2) To detour to the right, add 90 degrees to your original azimuth.
- (3) Using the new azimuth, pick a steering mark and move toward it, making sure you begin a new pace count. Move on this azimuth until you reach the end of the obstacle.
- (4) Stop and note the number of paces taken, and again add or subtract 90 degrees from the azimuth just read, and move to the far side of the obstacle.
- (5) Upon reaching the far side, stop the count and note the number of paces taken; add this number to the pace count noted in step (1).
- (6) Again add or subtract 90 degrees from the azimuth used, and then move the same number of paces you took on the first leg of your offset or detour.
- (7) Place the compass on your original azimuth, pick up the pace count you ended with when you cleared the obstacle, and proceed to your finish point.

## Performance Steps

f. Bypassing the same obstacle at night calls for special considerations:

(1) To make a 90-degree turn, hold the compass as you would to determine a magnetic azimuth.

(2) Turn until the center of the luminous letter "E" is under the luminous line (do not change the setting of the luminous line).

*Note:* If you turn to the right, "E" is under the luminous line. If you turn to the left, "W" is under the line.

(3) Proceed in that direction until you outflank the obstacle.

(4) Turn until the north arrow is under the luminous line, and then proceed parallel to your original course until you have bypassed the obstacle.

(5) Turn until the "W" is under the luminous line and move back the same distance you originally moved.

(6) Finally, turn until the North arrow is under the luminous line, and then proceed on your original course.

(7) You must count your paces just as you do when you bypass an obstacle in daylight.

g. After reaching the finish point, conduct a detailed terrain analysis to confirm your location.

4. Navigate from one point to another by comparing and combining terrain association with dead reckoning.

a. You will often have to consider the advantages and disadvantages of each technique.

(1) Terrain association is fast and easy, and it allows for mistakes. It also is subject to map accuracy and can only be used with recognizable terrain features.

(2) Dead reckoning is accurate and works on flat terrain that lacks terrain features; however, all work must be precise, and the technique takes time.

b. Sometimes you will have to combine the techniques. For instance, in the desert, you might need to use dead reckoning to arrive at or near a road or ridge, and then use terrain association to follow that feature to an objective.

---

**Evaluation Preparation:** *Setup:* Select an area with varying terrain and vegetation that is large enough to have two points 1,000 to 2,000 meters apart. Each point is on or near an identifiable terrain feature and is marked on the ground with a sign containing a letter or number. Dummy signs are placed not less than 100 meters nor more than 200 meters to the right and left of the correct point. Clearly mark correct points on the map. Prepare a sheet of paper giving the azimuth and distance for each leg of the course to be covered. Have pencils available for the tested Soldier.

*Brief Soldier:*

1. Terrain Association.

a. Give the Soldier the map and tell him/her to identify the best route to take between the two points that have been plotted on the map (1,000 to 2,000 meters apart).

*Note:* The best route must have been determined by an subject matter expert (SME) before the test.

b. Give the Soldier the map and tell him/her the he/she must move from point A on the map to point B (1,000 to 2,000 meters apart) using terrain association (no compass is used). Tell the Soldier he/she has \_\_\_\_\_ time to complete the course.

2. Dead Reckoning. Give the Soldier the sheet of paper with the azimuth and the distance for each leg of the course (three to five points, 200 to 500 meters apart), and the compass; no map will be used. Tell the Soldier to move over the course shown by the azimuth and the distance on the paper. Tell the Soldier to record the letter or number at the end of each leg of the course. Tell the Soldier that he/she has \_\_\_\_\_ time to complete the course.

**Note:** Time standards are based on the average time it takes two SMEs to complete the course plus 50 percent. For example, SME time, 1 hour. 1 hour added to 50 percent = Course Test Time of 1 hour 30 minutes.

Soldiers being tested are given 10 minutes to study the map and to determine their course of action. At the end of this time, the Soldier moves to the start point and begins the test. Time starts when Soldiers leave the start point and ends when the finished point is crossed.

Performance Measures	GO	NO GO
1. Terrain association.	_____	_____
a. Within 10 minutes, identified the best route, and explained why you picked it.		
b. Wrote down the correct letter or number at the end of each leg of the course.		
2. Dead reckoning.	_____	_____
a. Wrote down the correct letter or number of each leg of the course.		
b. Arrived at the correct destination within the specified time.		

**Evaluation Guidance:** Refer to chapter 1, paragraph 1-9e, (1) and (2).

**References**

**Required:** FM 3-25.26 and STP 21-1-SMCT

**Related:**

## 071-329-1008

### Measure Distance on a Map

**Conditions:** Given a standard 1:50,000-scale military map, a strip of paper with a straight edge, and a pencil.

**Standards:**

- Determine the straight-line distance between two points in meters with no more than 5 percent error.
- Determine the road (curved line) distance between two points in meters with no more than 10 percent error.

## Performance Steps

1. Identify the scale of the map. The map scale is the ratio (1:50,000) of the distance on the map (1 inch) relative to the distance on the ground (usually 50,000 inches).
2. Convert a straight-line map distance to miles, meters, or yards using the map's bar scale (figure 071-329-1008-1).

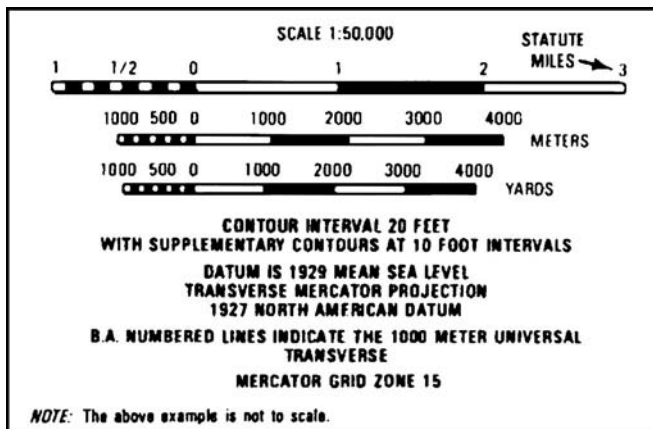

Figure 071-329-1008-1. Bar scales

- a. For map distances less than or equal to 1 inch—
  - (1) Line up the straight edge of a strip of paper with the beginning and ending points on the map.
  - (2) Mark on the straight edge of the paper the beginning and ending points (figure 071-329-1008-2).

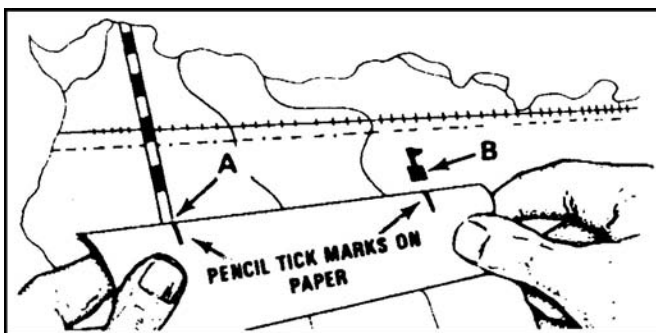

Figure 071-329-1008-2. Measuring distance

- (3) Match the marks on the paper with the appropriate bar scale (figure 071-329-1008-3).

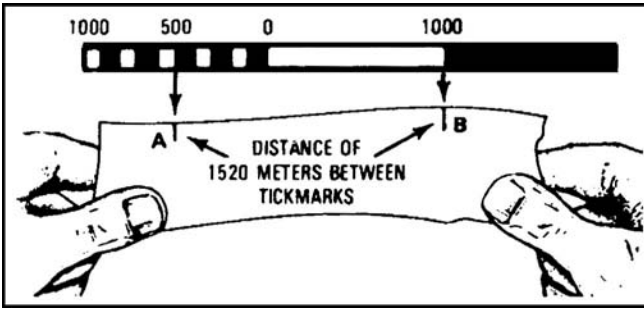

Figure 071-329-1008-3. Determining distance

(4) Determine the distance on the scale that compares to the distance on the paper.

b. For map distances greater than 1 inch—

(1) Line up the straight edge of a strip of paper with the beginning and ending points on the map.

(2) Mark the beginning and ending points on the straight edge of the paper (figure 071-329-1008-2).

(3) Place the starting point on the paper under the zero on the bar scale.

(4) Measure off 4,000 meters and place a new tick mark on the paper.

(5) Place the new tick mark under the zero on the bar scale.

(6) Determine if the end point falls within the bar scale.

(a) Record the value on the scale of the end point, if the end point fits on the scale.

(b) Add 4,000 meters to this value (a) to get the total difference.

(7) Determine if the end point falls outside the bar.

(a) Repeat steps 2b(4) and (5) until the end point falls within the bar.

(b) Add 4,000 meters to the value you derived in step 2b(6)(a) for each time you performed step 2b(4). This is the total difference.

3. Convert a road map distance to miles, meters, or yards using the map's bar scale. This is the actual distance you have to travel to reach the point from the straight-line distance you identified in step 2.

a. Line up the straight edge of a strip of paper with the beginning point and the point where the road makes the first curve on the map.

b. Mark on the straight edge of the paper the beginning and curve points.

c. Repeat steps 3a and b, each time using the point of the curve as the next beginning point, until you reach the end point.

### Performance Steps

d. Use this step (3) to determine the road distance in miles, meters, or yards as appropriate.

(1) If the total distance measured on the paper is less than or equal to 1 inch, use steps 2a(3) and (4).

(2) If the total distance measured on the paper is more than 1 inch, use steps 2b(3) through (7).

**Evaluation Preparation:** *Setup:* In the field or classroom, give the Soldier a 1:50,000-scale military map, a strip of paper with a straight edge, and a pencil. On the map, plot a straight-line distance of 3,000 to 4,000 meters. Mark this distance points A and B. On a road or trail, plot a curved-line distance of 3,000 to 4,000 meters with at least two changes of direction. Mark this distance points C and D.

*Brief Soldier:* Tell the Soldier to determine the straight-line distance between points A and B with no more than 5 percent error, and the curved-line distance between points C and D with no more than 10 percent error. The Soldier must either write down the correct answers or state them when asked by the scorer.

Performance Measures	GO	NO GO
1. Identified the scale of the map.	___	___
2. Converted the straight-line map distance to miles, meters or yards using the map's bar scale, with no more than 5 percent error.	___	___
3. Converted the road map distance to miles, meters, or yards using the map's bar scale, with no more than 10 percent error.	___	___

**Evaluation Guidance:** Refer to chapter 1, paragraph 1-9e, (1) and (2).

### References

**Required:** FM 3-25.26

**Related:**

## 071-329-1009

### Convert Azimuths

**Conditions:** Given a standard 1:50,000 scale military map with a declination diagram, a pencil, and magnetic and grid azimuths that must be converted.

**Standards:** Convert the given magnetic azimuth to a grid azimuth and the given grid azimuth to a magnetic azimuth without error.

### Performance Steps

1. The North-South lines on your map give grid north. The needle of your compass points to magnetic north. Grid north and magnetic north usually differ by a few degrees. Neither points straight to the North Pole (called true North). However, you need not know true North to keep from getting lost in a combat area. The difference in degrees for every map is shown on the bottom of map sheet (figure 071-329-1009-1).

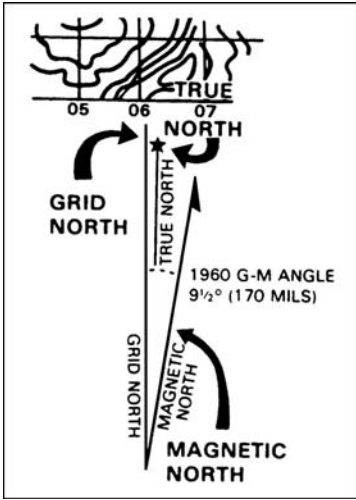

Figure 071-329-1009-1. Declination diagram

2. The difference between grid north and magnetic north is called the grid-magnetic (G-M) angle. The diagram at the bottom of the map tells you how to change grid azimuths to magnetic azimuths and magnetic azimuths to grid azimuths (figure 071-329-1009-2). For example, you aim your compass at a distant point. The compass reading you get is 190 degrees, the magnetic azimuth. The diagram on your map (figure 071-329-1009-2) tells you that the G-M angle is 9 degrees, and it also tells you that "to convert a magnetic azimuth to a grid azimuth, add the G-M angle." Therefore add 9 degrees to your compass reading. This gives you  $190+9=199$ . Your grid azimuth is 199 degrees.

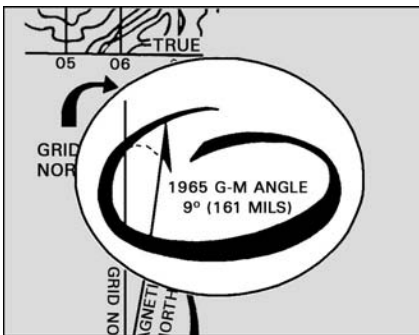

Figure 071-329-1009-2. G-M angle

3. The G-M angle depends on where you are in the world.
  - a. Easterly G-M. Convert azimuths when given an easterly G-M angle (figure 071-329-1009-3).



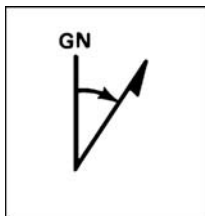

Figure 071-329-1009-3. Converting azimuths with easterly G-M angle

(1) To convert a magnetic azimuth to a grid azimuth, add the value of the G-M angle to the magnetic azimuth.

(2) To convert a grid azimuth to a magnetic azimuth, subtract the G-M angle from the grid azimuth.

b. Westerly G-M. Convert azimuths when given a westerly G-M angle (figure 071-329-1009-4).

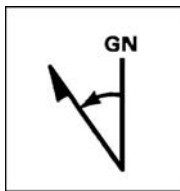

Figure 071-329-1009-4. Converting azimuths with westerly G-M angle

(1) To convert a magnetic azimuth to a grid azimuth, subtract the value of the G-M angle from the magnetic azimuths.

(2) To convert a grid azimuth to a magnetic azimuth, add the value of the G-M angle to the grid azimuth.

**Evaluation Preparation:** *Setup:* Give the Soldier a standard 1:50,000 scale military map, a piece of paper, a pencil, and a magnetic and grid azimuth to convert.

*Brief Soldier:* Tell the Soldier to convert the magnetic azimuth to a grid azimuth and the grid azimuth to a magnetic azimuth.

Performance Measures	GO	NO GO
1. Determined the correct grid azimuth.	_____	_____
2. Determined the correct magnetic azimuth.	_____	_____

**Evaluation Guidance:** Refer to chapter 1, paragraph 1-9e, (1) and (2).

**References**

**Required:** FM 3-25.26

**Related:**

---

## 071-329-1011

### Orient a Map Using a Lensatic Compass

**Conditions:** Given a field table, a standard 1:50,000 scale military map, a protector, a pencil, paper, and a compass in daylight.

**Standards:** Orient the map to the ground using a compass. The North-seeking arrow of the compass must fall within 3 degrees (50 mils) of the angle shown in the grid-magnetic (G-M) angle on the map's declination diagram.

#### Performance Steps

1. With the map level, place the compass parallel to a north-south grid line with the cover side of the compass pointing towards the top of the map. This will place the black index line on the dial of the compass parallel to grid north. Since the needle on the compass points to magnetic north, a declination diagram on the face of the compass is formed by the index line and the compass needle.
2. Rotate the map and compass until the directions of the declination diagram formed by the black index line and the compass needle match the direction shown in the declination diagram printed on the margin of the map. Orient the map.

**Note:** If the magnetic north arrow on the map is to the left of the grid north, the compass reading equals the G-M angle (given the declination diagram). If the magnetic north is to the right of the grid north, the compass reading equals 360 degrees (6,400 mils) minus the G-M angle.

3. Remember to point the compass north arrow in the same direction as the magnetic north arrow (step 2 above). The compass reading (equal to the G-M angle or the 360 degrees [6,400 mils] minus the G-M angle) will be apparent.

**Note:** If the G-M angle is less than 3 degrees (50 mils), do not line up the north arrow.

4. Orient a map using a built-in protractor.
  - a. Some maps have a built-in protractor considering of a pivot point "P" on the south neat line of the map and several degrees of arc along the north neat line of the map. The G-M line is obtained by connecting pivot "P" with the appropriate value of the G-M angle (taken from the declination diagram) on the arc. Orient the map by placing the compass parallel on this line. Rotate the map and compass until the needle point aligns with the continuous line formed by the index line and the sighting wire. Orient the map.
  - b. An alternate method is to draw a magnetic north line on the map from any N-S and E-W grid line intersection using the protractor. Align the straightedge of the compass along this magnetic north line. Rotate the map and compass together, until the north arrow falls beneath the fixed black index line on the compass.

---

**Evaluation Preparation:** *Setup:* Select an area that is free of magnetic interference (power lines, vehicles). Provide a field table, 1:50,000 scale military map, a protractor, a pencil, paper and compass.

*Brief Soldier:* Tell the Soldier to orient the map to the ground using the compass. Tell the Soldier to use the G-M angle shown by the declination diagram if it exceeds 3 degrees (50 mils).

Performance Measures	GO	NO GO
1. Determined whether G-M angle exceeded 3 degrees (50 mils)	_____	_____
2. Aligned the side of the compass with one of the North-South grid lines.	_____	_____
3. Positioned the cover of the compass toward the top of the map.	_____	_____
4. Oriented the map.	_____	_____
5. Corrected the orientations of the map when the G-M angle exceeded 3 degrees (50 mils) using one of the following methods:	_____	_____
a. Formed the G-M angle with the black index line and the needle on the compass.	_____	_____
b. Used the pivot point "P" on the south neat line and the degrees of arc along the north neat line; placed the compass along this line.	_____	_____
c. Drew a magnetic north line from any N-S and E-W grid the intersection using a protractor and placed the compass along this line.	_____	_____
<i>Note:</i> Step 5 was only required when the G-M angle was greater than 3 degrees or 50 mils. Step 5b was only tested if the map had the built-in protractor.		

**Evaluation Guidance:** Refer to chapter 1, paragraph 1-9e, (1) and (2).

**References**

**Required:** FM 3-25.26

**Related:**

## 071-329-1012

### Orient a Map to the Ground by Map-Terrain Association

**Conditions:** Given a standard 1:50,000 scale military map in the field in daylight.

**Standards:** Orient the map to within 30 degrees of north.

**Performance Steps**

1. Match terrain features appearing on your map with physical features on the ground (figure 071-329-1012-1).

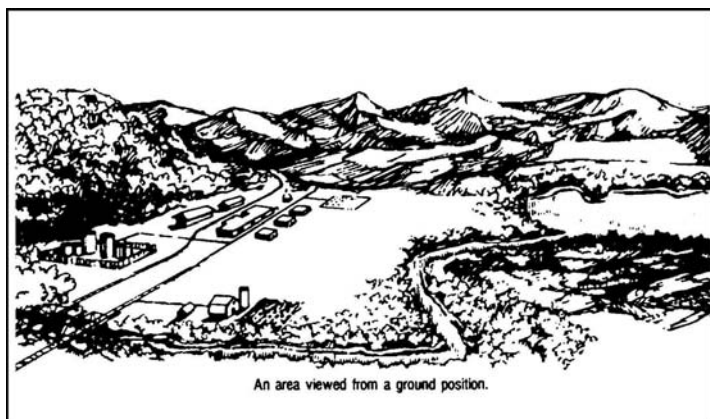

Figure 071-329-1012-1. Features used to orient map

- a. Hold the map in a horizontal position.
  - b. Line up features on the ground with those on the map.
2. Check orientations obtained by this method by placing a compass along one of the North-South grid lines. Do this to keep from orienting the map in the wrong direction, that is, 180 degrees out. Or, check orientations by aligning two or more features. Incorporate the declination constant in determining the 30 degrees.

**Evaluation Preparation:** *Setup:* Use an area of terrain with identifiable terrain features, natural, man-made, or both. Provide a field table and a 1:50,000-scale map of the area.

*Brief Soldier:* Tell the Soldier to use the terrain features and orient the map to within 30 degrees of north.

Performance Measures	GO	NO GO
1. Matched terrain features by holding the map in a horizontal position and lining up the features on the ground.	___	___
2. Checked orientations.	___	___

**Evaluation Guidance:** Refer to chapter 1, paragraph 1-9e, (1) and (2).

**References**

**Required:** FM 3-25.26

**Related:**

## 071-329-1014

### Locate an Unknown Point on a Map and on the Ground by Intersection

**Conditions:** Given a standard 1:50,000 scale military map of the area, the location of two known points, a compass, a straight edge, a coordinate scale and protractor (GTA 5-2-12), a pencil, and an object or terrain feature.

**Standards:** Determine the 100,000-meter-square identification letters and six-digit grid coordinates of the object or terrain feature to within 100 meters.

**Performance Steps**

1. Use the map and compass method (figure 071-329-1014-1).

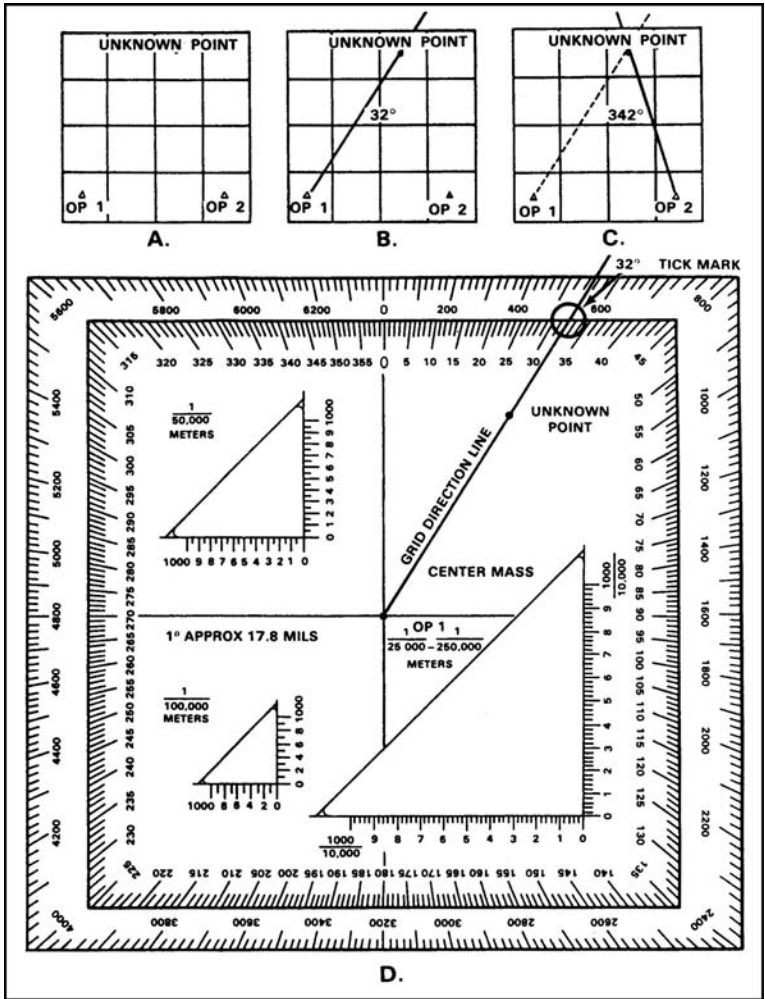

Figure 071-329-1014-1. Location of an unknown point

*Note:* The example map is not to scale; an easterly G-M angle to 10 degrees is used in the examples.

- a. Determine the G-M angle of the map you are using.
- b. Locate and mark your position on the map.

## Performance Steps

- c. Convert the magnetic azimuth to the unknown point (22 degrees); change it to a grid azimuth. In the example, the G-M angle used is 10 degrees easterly, giving a grid azimuth of 32 degrees.
  - d. Place the protractor on the map, ensuring that the zero-degree indication on the protractor is pointing to the top of the map (North) and the index point is placed center of mass on your location (figure 071-329-1014-1). Place a tick mark at the number of degrees you want to plot. Draw a line on the map from your position on this grid azimuth (32 degrees).
  - e. Move to or call a second known position from which the unknown point can be seen. Locate this position on the map.
  - f. Repeat c and d.
  - g. Where the lines cross is the location of the unknown point.
2. Use the straight edge method (when no compass is available) (figure 071-329-1014-2).

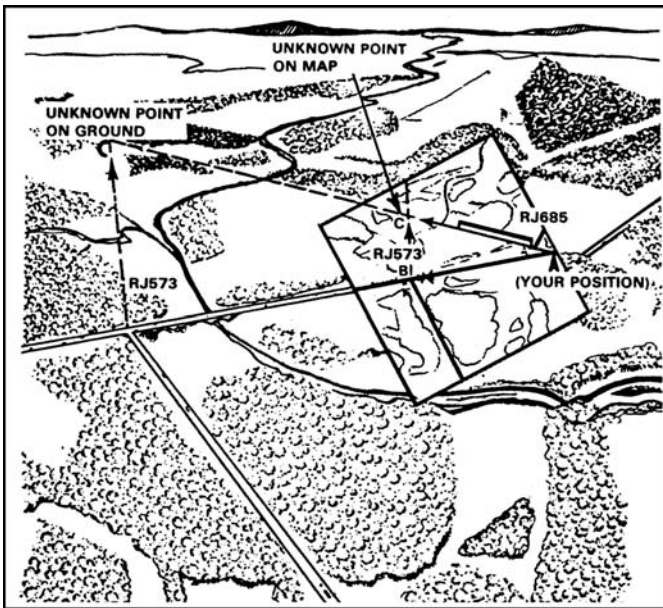

Figure 071-329-1014-2. Intersection without compass

- a. See the task Orient a Map to the Ground by Map-Terrain Association, 071-329-1012 in this STP.
- b. Locate and mark your position on the map.

### Performance Steps

- c. Lay a straight edge on the map with one end at the user's position (A) as a pivot point. Rotate the straight edge until the unknown point is sighted along the edge.
- d. Draw a line along the straight edge.
- e. Repeat paragraphs b, c, and d at position (B) and, for check for accuracy, at a third position.
- f. The intersection of the lines is the location of the unknown point (C).

**Evaluation Preparation:** *Setup:* In a field location, give the Soldier a standard 1:50,000 scale military map of the area, a compass, a straight edge, a coordinate scale and protractor, a pencil, an unknown point, and two points (at least 400 meters apart) from which to determine azimuths to the unknown point.

*Brief Soldier:* Tell the Soldier to determine the six-digit grid coordinates of the unknown point.

Performance Measures	GO	NO GO
1. Determined the six-digit grid coordinates, to include the 100,000-meter square identifier of the unknown point, within 100 meters.	_____	_____

**Evaluation Guidance:** Refer to chapter 1, paragraph 1-9e, (1) and (2).

### References

**Required:** FM 3-25.26 and STP 21-1-SMCT

**Related:**

## 071-329-1015

### Locate an Unknown Point on a Map and on the Ground by Resection

**Conditions:** Given an unknown location, a standard 1:50,000 scale military map of the area, a compass, a straightedge, a coordinate scale and a protractor (GTA 5-2-12), a pencil, and two terrain features visible from your location and identifiable on the map.

**Standards:** Determine the 100,000-meter square identification letters and six-digit coordinate of your location to within 100 meters of the actual grid coordinates.

### Performance Steps

1. Use the map and compass method (figure 071-329-1015-1).

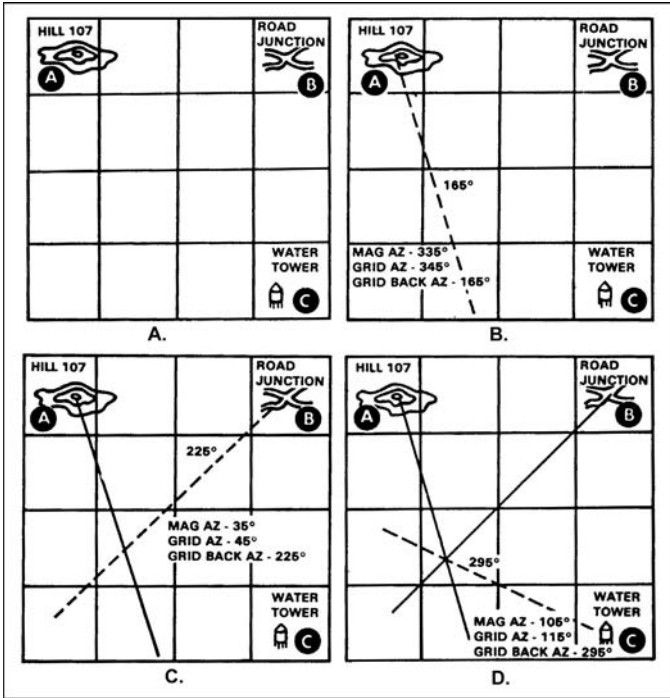

Figure 071-329-1015-1. Using the map and compass

*Note:* The example map is not to scale. The example uses an easterly G-M angle of 10 degrees.

- a. Determine the G-M angle of the map you are using.
- b. Locate two known positions on the ground and mark them on your map (A, figure 071-329-1015-1).
- c. Using your compass, measure the magnetic azimuth to one of the known locations; change it to a grid azimuth (B, figure 071-329-1015-1).
  - (1) If it is a westerly G-M angle, subtract the number of degrees in the G-M angle from your magnetic azimuth.
  - (2) If it is an easterly G-M angle, add the number of degrees in the G-M angle to your magnetic azimuth.
- d. Change this grid azimuth to a back azimuth.
- e. Place the protractor on the map, ensuring that the zero-degree indicators on the protractor point to the top of the map (North), and the index point is center of mass on this location. Place a tick mark at the number of degrees you want to plot. Remove the protractor from the map and draw a line on the map from this position on the grid back azimuth you found, in the direction of your unknown position.







Figure 071-329-1015-3. Resection without a compass continued

3. To perform a modified resection, you must be located on a linear feature such as a road, stream bank, railroad, or ridge. First orient your map, and then find a feature also on the map, such as the water tower in the previous example. Just as before, put a straightedge through the water tower on the map and align the straightedge through so that it points directly at the real water tower. Draw a line along the ruler or straightedge. The point where the line crosses the linear feature, which you know you are on, is your location.

*Note:* Always orient your map as closely as you can. The compass is the best way to do so. If you do not have a ruler, use your rifle cleaning rod or a section of the radio antenna as a straightedge.

**Evaluation Preparation:** *Setup:* Give the Soldier a standard 1:50,000 scale military map of the local area, a compass, a coordinate scale and a protractor (GTA 5-2-12), a pencil, a straightedge, and the location of two known points.

*Brief Soldier:* Tell the Soldier to determine the six-digit coordinates for his/her location.

Performance Measures	GO	NO GO
1. Determined the six-digit grid coordinate and the 100,000-meter square identifier of his/her position (unknown point) within 100 meters.	_____	_____

**Evaluation Guidance:** Refer to chapter 1, paragraph 1-9e, 1 and 2.

**References**

**Required:** FM 3-25.26

**Related:**

---

## 071-329-1018

### Determine Direction Without a Compass

**Conditions:** During daylight and at night (with a clear view of the Big Dipper), given a wristwatch (not digital) and natural vegetation in a field environment.

**Standards:** Identify North and East within 15 degrees.

**Note:** This task uses approximate directions. Use a compass to obtain accurate directions.

#### Performance Steps

1. Determine direction using the shadow-tip method.
  - a. Place a stick or branch into the ground vertically at a fairly level spot where the sun will cast a distinct shadow. Mark the shadow with a stone, twig, or other means (figure 071-329-1018-1).

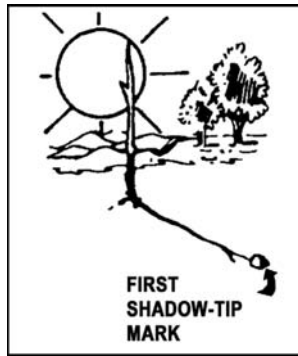

Figure 071-329-1018-1. First shadow-tip mark

- b. Wait 10 or 15 minutes until the shadow tip moves a few inches. Mark the new position of the shadow tip just like the first (figure 071-329-1018-2).

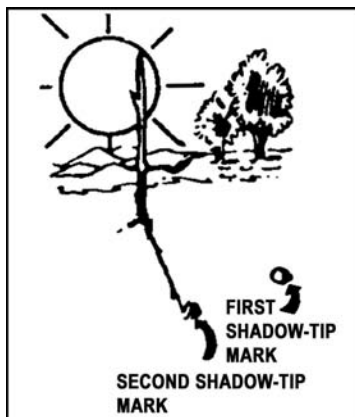

Figure 071-329-1018-2. Second shadow-tip mark

**Performance Steps**

- c. Draw a straight line through the two marks you made on the shadow tips. This line is an East-West line (figure 071-329-1018-3).

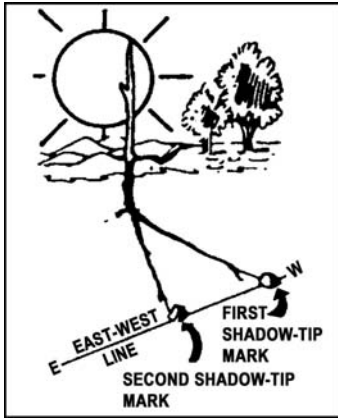

Figure 071-329-1018-3. East-west line

- d. Determine which is the East end of the line and which is the West end.
- (1) The sun rises in the East and sets in the West.
  - (2) The first shadow tip you mark will always be West, and the second mark will always be East.
  - (3) The shadow tip moves in the opposite direction.
- e. Determine North and South. Draw a line at a right angle to the East-West line at any point (figure 071-329-1018-4). This is the North-South line.

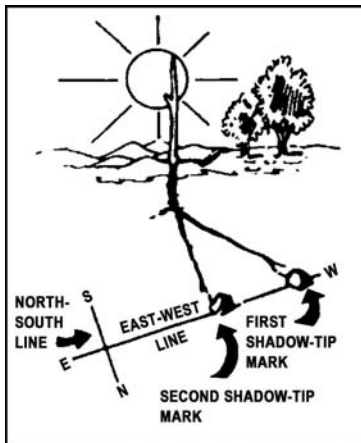

Figure 071-329-1018-4. North-south line

2. Determine direction using the watch method without a compass.

## Performance Steps

a. Point the hour hand at the sun when you are North of the equator. South will be halfway between the hour hand and 12 o'clock (figure 071-329-1018-5).

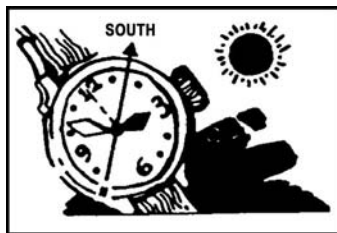

Figure 071-329-1018-5. Watch method

b. Point 12 o'clock at the sun when you are South of the equator. North will be halfway between the hour hand and 12 o'clock.

3. Use the North Star method to determine direction at night. At night, you can locate north by finding the North Star (Polaris). First, find the Big Dipper. The last two stars in the cup point directly at Polaris, which is about five times as far out as the distance between those two stars in the cup. Facing Polaris, you are looking North, with East on your right and West on your left (figure 071-329-1018-6).

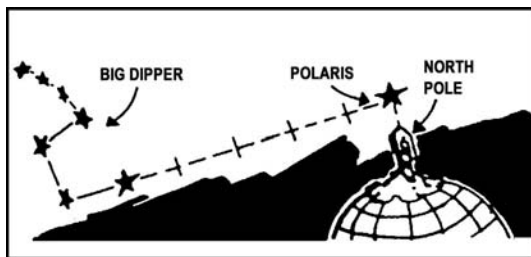

Figure 071-329-1018-6. North Star method

**Evaluation Preparation:** *Setup:* Directionally orient yourself to an area that is unfamiliar to the Soldier to be tested.

*Brief Soldier:* Accompany the Soldier to the area. Tell the Soldier to use field-expedient methods to locate North and East. Use a compass direction of your choice. The Soldier will not be told how he/she did on performance measure 1 until he/she completes performance measure 2.

**Note:** Before the Soldier is scored a GO for this task, he/she must display proficiency in all three field-expedient methods of determining direction without a compass. However, performance measure 3 must be tested in a different location.

During the training session, stress these four facts:

- The sun rises in the East and sets in the West.
- When you face North, East is to your right, West is to your left, and South is to your back.

- The Big Dipper is a pattern of stars that resembles a soup ladle.
- The Southern Cross is the main constellation used as a guide South of the equator, and the above general directions for using North and South stars are reversed.

Performance Measures	GO	NO GO
1. Determined direction using the shadow-tip field-expedient method.	_____	_____
2. Determined direction using the watch field-expedient method.	_____	_____
3. Determined direction using the North Star field-expedient method.	_____	_____

**Evaluation Guidance:** Refer to chapter 1, paragraph 1-9e, (1) and (2).

**References**

**Required:** FM 3-25.26

**Related:**

## 071-329-1030

### Navigate from One Point on the Ground to Another Point While Mounted

**Conditions:** Given a standard 1:50,000-scale topographic map of the area, a coordinate scale, a protractor, and a compass, while mounted in a vehicle with cross-country capability.

**Standards:** Direct the driver to the designated point(s) at a rate of 9 kilometers per hour using terrain association and dead reckoning.

#### Performance Steps

1. Determine the effects of terrain on the vehicle when navigating mounted.
  - a. Vehicle speed and mobility.
    - (1) Great distances can be covered quickly. Develop the ability to estimate the distance traveled. Meanwhile, use the odometer, which shows the distance traveled. Remember that 0.1 mile is about 160 meters, and 1 mile is about 1,600 meters (1.6 kilometers).
    - (2) Mobility is an advantage while navigating. When disoriented, mobility makes it easier to move and reorient.
  - b. Vehicle capabilities.
    - (1) Most military vehicles can knock down a tree. Larger vehicles can clear more trees but cannot knock down several trees at once. Find paths between trees that are wide enough for the vehicle (figure 071-329-1030-1).

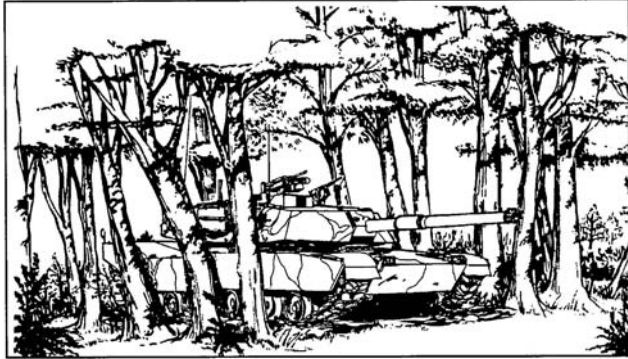

Figure 071-329-1030-1. Vehicle capabilities

**CAUTION**

During training, follow installation SOP or local guidelines concerning cross-country vehicle travel.

(2) Military vehicles are designed to climb 60-percent (30-degree) slopes if the surface is dry and firm. If gravel, vegetation, or mud is on the slope, the practical slope-climbing capability is about 40 percent (20 degrees, figure 071-329-1030-2).

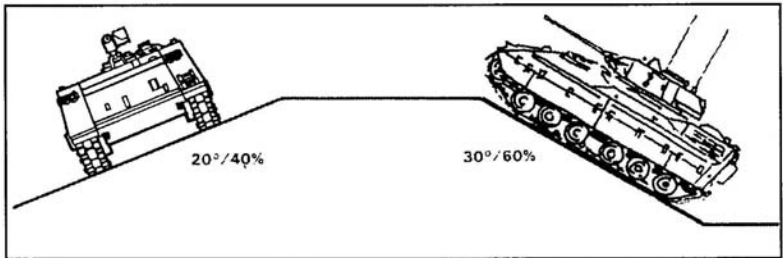

Figure 071-329-1030-2. Climbing slope and side slope capabilities

(a) Determine the approximate slope by looking at the route selected on a map. One contour line in any 100 meters of map distance on that route indicates a 10-percent slope. Two contour lines indicate a 20-percent slope, and so forth. If there are four contour lines in 100 meters, look for another route.

*Note:* The above figures are true for a 10-meter or 20-foot contour interval. If the map has a different contour interval, adjust the arithmetic. For instance, if there is one contour line in 100 meters, a 10-meter interval would give a 10-percent slope.

(b) The side slope is more important than the climbing slope. A 40-percent side slope is the maximum in good weather (figure 071-329-1030-2). Traverse a side slope slowly and without turning. Rocks, stumps, or sharp turns can cause a downhill track to be thrown under the vehicle, which is a major recovery task.

(3) For tactical reasons, movement is often in draws or valleys due to the cover they provide. Side slopes make slow movement necessary.

## Performance Steps

2. Know the effects of weather on vehicle movement.

a. Weather can halt mounted movement. Snow and ice are dangerous. Rain and snow affect soil load-bearing ability. Heavy rain may restrict cross-country vehicles to road movement.

b. Adjust the route to avoid flooded or muddy areas. A stuck vehicle hinders combat capability.

3. Know both methods of navigation.

a. Terrain association. This is the most used method of navigation. The navigator plans the route for movement from one terrain feature to another. An automobile driver uses the same technique while driving along the streets in a city. Hesse guides himself/herself using intersections or other landmarks. Like a driver, the navigator selects routes, or "streets," between key points, or "intersections." These routes must sustain vehicle travel, and they should be as direct and easy to follow as possible. In a typical move, the navigator determines his/her location and the location of his/her objective. He/she notes the position of each on his/her map and selects a route between the two.

(1) Determine the start point and destination.

(2) Draw or visualize a straight line between the two points on the map.

(3) Inspect the terrain along that line for ease of movement, for features recognizable under predicted weather conditions, and for tactical considerations.

(4) After analyzing the terrain, adjust the route as follows:

(a) Consider tactical aspects. Avoid skylining, select key terrain for overwatch positions, and select concealed routes.

(b) Consider ease of movement. Use the easiest possible route. Bypass difficult terrain. A difficult route is hard to follow. It is also noisier, slower, and causes more wear to the vehicle (and possibly recovery problems). Achieve tactical surprise by doing the unexpected. Try to select an axis or corridor, not a specific route. Allow room for vehicles to maneuver.

(c) Use terrain features as checkpoints. They must be easily recognizable under the current light and weather conditions and from a moving vehicle. The best checkpoints are linear features that cross the route. Use perennial streams, rivers, hardtop roads, ridges, valleys, and railroads. The next best are elevation changes; hills, depressions, spurs, and draws. Look for two contour lines of change. Less than two lines of change cannot be spotted while mounted.

(d) Follow terrain features. Movement and navigation along a valley floor or near or on the crest of a ridgeline are easiest.



## Performance Steps

(e) Determine directions. Break the route down into smaller segments and determine the rough direction to follow. You do not need a compass. Just use the main points of direction such as North, Northeast, or East. Before moving, note the location of the sun and the direction of north. Locate changes of direction, if any, at the checkpoints chosen.

(f) Determine distance. Obtain the total distance to be traveled and the approximate distance between checkpoints. Plan to use the vehicle odometer to keep track of distance traveled.

*Note:* Convert the map distance to ground distance by adding 20 percent for cross-country movement.

(g) Make notes. Usually, mental notes are adequate. Imagine what the route will be like and remember it.

(h) Plan. Restudy the route selected. Determine where problems may occur and how you can avoid them.

b. Dead reckoning. This means moving a given distance in meters along a given line, which is usually an azimuth in degrees.

*Note:* There is no accurate method of determining direction in vehicles.

(1) Dead reckoning with steering marks. This procedure is the same for vehicle travel as it is on foot.

(a) Dismount from the vehicle.

(b) Move away from the vehicle (about 50 meters).

(c) Set the azimuth on the compass and choose a steering mark (rock, tree, hilltop) in the distance on that azimuth.

(d) Remount and have the driver identify the steering mark. Proceed to it in as straight a line as possible.

(e) On arrival at the steering mark or when direction changes, repeat paragraphs (a) through (c) for the next leg of travel.

(2) Dead reckoning without steering marks. Use this procedure only in flat, featureless terrain.

(a) Dismount from the vehicle, which has been positioned in the direction of travel. Move about 50 meters to the front of the vehicle.

(b) Face the vehicle and read the azimuth to the vehicle.

(c) Determine the forward azimuth (direction of travel) by adding or subtracting 180 degrees.

(d) Have the driver drive on a straight line toward you.

(e) Remount the vehicle, hold the compass as you will hold it while the vehicle is moving, and read the azimuth to the front.

## Performance Steps

(f) The compass swings off the azimuth determined, but it should pick up a constant deviation. For instance, the azimuth to the steering mark was 75 degrees while you were away from the vehicle. When you remounted, and the driver drove straight forward, the compass showed 67 degrees. This is a deviation of minus 8 degrees. All you have to do is to hold the 67-degree heading.

(g) At night, do the same thing, but without a steering mark. From the map, determine the azimuth of travel. Line up the vehicle on that azimuth, then move well in front of the vehicle. Be sure it is aligned correctly. Mount, have the driver move slowly forward, and note the deviation.

*Note:* Traversing the turret (if the vehicle has one) changes the deviation.

(3) Turret alignment. Another method, if the vehicle has a stabilized turret, is alignment of the turret on the azimuth to be traveled. Switch the turret stabilization system ON. The gun tube remains pointed at the destination, no matter which way you turn the vehicle.

### CAUTION

If you have to take the turret off-line to engage a target, repeat the entire process.

*Note:* This technique works, and is safe for the stabilization system. However, because the vehicle is subject to stabilization drift, use this technique for no more than 5,000 meters before resetting.

(4) Distance factor. Computing the distance factor in dead reckoning is usually a simple process. Determine the map distance to travel and add 20 percent to convert to ground distance. Use the vehicle odometer to control the distance of travel.

4. Learn to combine and use both methods.

a. Terrain association is fast and forgiving. It is the best method under most circumstances, and it can be used day or night.

b. Dead reckoning is accurate if done correctly, but precision is required. Dead reckoning is slow but works in flat terrain.

c. The two methods are often combined.

(1) Use dead reckoning to travel across a large, flat area to a ridge.

(2) Use terrain association for the rest of the move.

d. The ability to use both methods is required. Probable errors, in order of frequency, include the failure to—

(1) Determine distance(s) to be traveled.

(2) Travel the proper distance.

(3) Properly plot or locate the objective.

(4) Select easily recognized checkpoints or landmarks.

(5) Consider ease of movement.

---

**Evaluation Preparation:** *Setup:* At the test site, provide the materials and equipment given in the task condition statement. Select an area with varied terrain and vegetation. The area must be large enough to have three to five points at least 1,000 and up to 5,000 meters apart. Each point is on or near an identifiable terrain

feature. Mark them on the ground with a sign containing a letter or number. Place dummy signs between 100 and 200 meters to the right and left of the correct point. Clearly mark all correct points on the map. Prepare a sheet of paper giving the azimuth and distance for each leg of the course. Have pencils available for the Soldier.

*Brief Soldier:*

1. Terrain association. Give the Soldier the map and tell him/her to direct the driver and vehicle over the course recorded on the map. Tell the Soldier to record the letter or number at the end of each leg of the course. Tell the Soldier that he/she will cover the course using terrain association.
2. Dead reckoning with steering marks. Give the Soldier a protractor, a compass, and a sheet of paper with the azimuth and distance for each leg of the course and tell him/her—
  - That he/she will not use a map.
  - To direct the driver and vehicle over the course recorded on the paper.
  - To record the letter or number at the end of each leg to the course.
  - To cover the course using steering marks.

Performance Measures	GO	NO GO
1. Terrain association. Wrote the correct letter or number found at the end of each leg of the course.	_____	_____
2. Dead reckoning. <ol style="list-style-type: none"> <li>a. Moved away from the vehicle.</li> <li>b. Set the azimuth on your compass and selected a steering mark.</li> <li>c. Had the driver identify the steering mark.</li> <li>d. Wrote the correct letter or number found at the end of each leg of the course.</li> <li>e. Repeated performance measures 2a, b, and c for each leg of the course.</li> </ol>	_____	_____

**Evaluation Guidance:** Refer to chapter 1, paragraph 1-9e, (1) and (2).

**References**

**Required:**

**Related:** FM 3-25.26 and FM 90-3

**071-510-0001**

**Determine Azimuths Using a Protractor**

**Conditions:** Given a standard 1:50,000 scale military map with two known points plotted on the map, a protractor, a straightedge, and a pencil.

**Standards:** Determine the grid azimuth (in mils or degrees) from your location, point A, to point B, to within 1 degree or 20 mils.

## Performance Steps

- 1.** The direction from one point to another, either on the map or on the ground, is called an azimuth. Azimuths are given in degrees or mils in a clockwise direction from north, and all azimuths taken from a map are grid azimuths.
    - a.** An azimuth in degrees can be any number up to 360, since a circle has 360 degrees. Due East is 90 degrees, due South is 180 degrees, due West is 270 degrees, and due North is 360 degrees or 0 degrees.
    - b.** An azimuth in mils can be any number up to 6,400, since a circle has 6,400 mils. Due East is 1600 mils, due South is 3,200 mils, due West is 4,800 mils, and due North is 6,400 mils or 0 mils.
  - 2.** The most accurate way to determine an azimuth from a map is to use a protractor. The Army uses two types.
    - a.** The square protractor (GTA 5-2-12) has two scales. The inner scale is a degree scale, and the outer scale is the mil scale.
    - b.** The semicircular protractor might or might not have two scales, an outer one in mils and an inner one in degrees. Each scale has two rows of numbers. On both scales, the outer row is used to determine azimuths to the East of your position; the inner one is used to determine azimuths to the West of your position.
  - 3.** The most accurate way to determine an azimuth from a map is to use a protractor. The Army uses two types:
    - a.** The square protractor (GTA 5-2-12) has two scales. The inner scale is a degree scale, and the outer scale is the mil scale.
    - b.** The semicircular protractor might or might not have two scales, an outer one in mils and an inner one in degrees. Each scale has two rows of numbers. On both scales, the outer row is used to determine azimuths to the East of your position; the inner one is used to determine azimuths to the West of your position.
  - 4.** Use the protractor properly.
    - a.** Plot the location of two points on the map.
    - b.** Using a straightedge, draw a straight line (azimuth line) from point A to point B.
    - c.** Place the index of the protractor at the point where the azimuths line crosses one of the vertical (North-South) grid lines. This procedure allows greater accuracy in aligning the index line to a true reading where the azimuth line crosses the protractor scale.
-

### Performance Steps

**Note:** The line drawn between the two points must be long enough to cross the scale(s) of the protractor in order to read the azimuth. Should the line between the two points be too short to cross the scale(s), extend the line beyond point B until it crosses the scale(s).

**Note:** Ensure that the 0-degree or 0-mil mark on the protractor is toward the top (North) of the map.

d. Start at the 0-degree or 0-mil mark on the protractor and read to the right (clockwise) until you reach the point where the azimuth line crosses the scale(s) of the protractor.

**Note:** Each tick mark on the degree scale is 1 degree, while each tick mark on the mil scale is 20 mils.

e. Read the azimuth where the azimuth line crosses the scale(s).

(1) 65 degrees.

(2) 65 degrees – 1,150 mils.

**Note:** You can read the scale all the way around the square protractor. On the semicircular protractor, point B is to the left (West) of point A. Reverse the protractor so that 0 is toward the bottom of the map (South).

**Evaluation Preparation:** *Setup:* Provide the Soldier with a 1:50,000 scale military map, two points plotted and labeled (A) and (B), a protractor, a straightedge, and a pencil.

*Brief Soldier:* Tell the Soldier to determine the azimuth from point (A) to point (B) within one degree or 20 mils.

Performance Measures	GO	NO GO
1. Determined the correct azimuth (within 1 degree or 20 mils).	_____	_____

**Evaluation Guidance:** Refer to chapter 1, paragraph 1-9e, (1) and (2).

### References

**Required:** FM 3-25.26 and GTA 05-02-12

**Related:**

## 071-510-0002

### Compute Back Azimuths

**Conditions:** Given azimuths.

**Standards:** Determine the back azimuth of a given azimuth to the exact degree or mils.

### Performance Steps

1. Determine a back azimuth using degrees. Suppose you follow a 65-degree azimuth from point A to point B, and then you want to go back to your original location. To do this, you use a back azimuth. You simply add 180 to the first azimuth. Your back azimuth is  $65 + 180 = 245$  degrees.

## Performance Steps

2. Determine a back azimuth using mils. You move from point A to point B on an azimuth of 1150 mils. Should you wish to return to point A, you would follow a back azimuth. To determine the back azimuth you simply add 3,200 mils to 1,150.

$$3,200 + 1150 = 4,350 \text{ mils}$$

**Note:** Remember these rules:

Degrees:

- For angles less than 180 degrees, add 180 degrees.
- For angles more than 180 degrees, subtract 180 degrees.

Mils:

- For angles less than 3,200 mils, add 3,200 mils.
- For angles more than 3,200 mils, subtract 3,200 mils.

**Evaluation Preparation:** *Setup:* Provide the Soldier with azimuths, one in degrees and one in mils.

*Brief Soldier:* Tell the Soldier to compute the exact back azimuths.

Performance Measures	GO	NO GO
1. Computed the exact back azimuth.	___	___

**Evaluation Guidance:** Refer to chapter 1, paragraph 1-9e, (1) and (2).

## References

**Required:** FM 3-25.26

**Related:**

## SUBJECT AREA 6: COMMUNICATE

# 113-571-1022

## Perform Voice Communications

**Conditions:** Given: 1. One operational radio set for each net member, warmed up and set to the net frequency. 2. A call sign information card (5 x 8) consisting of: Net member duty position (S-1, S-2), net call sign (letter-number-letter), suffix list (Net Control Station [NCS] - 46, S-1 - 39, S-2 - 13), and a message to be transmitted. 3. Situation: The net is considered to be secure and authentication is not required. 4. FM 24-18. **Note:** This task may have as many net members as there is equipment available. Each net member must have a different suffix and message to transmit.

**Standards:** Enter a radio net, send a message, and leave a radio net using the proper call signs, call sign sequence, prowords, and phonetic alphabet and numerals with 100 percent accuracy.

## Performance Steps

1. Enter the net.
  - a. Determine the abbreviated call sign and answering sequence for your duty position.
  - b. Respond to the NCS issuing a net call (figure 113-571-1022-1).

NET THIS IS E3E (NCS) OVER E3E (NCS) THIS IS E13 (1 <sup>st</sup> position) OVER E3E (NCS) THIS IS E39 (2 <sup>nd</sup> position) OVER E3E (NCS) THIS IS E46 (3 <sup>rd</sup> position) OVER NET THE E3E (NCS) OUT (IF NCS HAS NO TRAFFIC)
---

**Figure 113-571-1022-1. Sample net call (initiate)**

- c. Answer in alphanumeric sequence.
- Note:* At this time, the NCS acknowledges and the net is open.
2. Send a message.
  - a. Listen to make sure the net is clear. Do not interrupt any ongoing communications.
  - b. Call the NCS and tell the operator the priority of the message you have for his/her station.
  - c. Receive a response from the NCS that he/she is ready to receive.
  - d. Send your message using the correct prowords and pronunciation of letters and numbers. (See tables 113-571-1022-1 through 113-571-1022-3 and figure 113-571-1022-2.)

**Table 113-571-1022-1. Phonetic alphabet**

A	ALFA	<u>AL</u> FAH
B	BRAVO	<u>BRAH</u> VOH
C	CHARLIE	<u>CHAR</u> LEE or <u>SHAR</u> LEE
D	DELTA	<u>DELL</u> TAH
E	ECHO	<u>ECK</u> OH
F	FOXTROT	<u>FOKS</u> TROT
G	GOLF	GOLF
H	HOTEL	HOH <u>TELL</u>
I	INDIA	<u>IN</u> DEE AH
J	JULIETT	<u>JEW</u> LEE <u>ETT</u>
K	KILO	<u>KEY</u> LOH
L	LIMA	<u>LEE</u> MAH
M	MIKE	MIKE
N	NOVEMBER	NO <u>VEM</u> BER
O	OSCAR	<u>OSS</u> CAH
P	PAPA	PAH <u>PAH</u>
Q	QUEBEC	KEH <u>BECK</u>
R	ROMEO	<u>ROW</u> ME OH
S	SIERRA	SEE <u>AIR</u> RAH
T	TANGO	<u>TANG</u> GO
U	UNIFORM	<u>YOU</u> NEE FORM or <u>OO</u> NEE FORM
V	VICTOR	<u>VIK</u> TAH
W	WHISKEY	<u>WISS</u> KEY
X	XRAY	<u>ECKS</u> RAY
Y	YANKEE	YANG KEY
Z	ZULU	<u>ZOO</u> LOO

**Table 113-571-1022-2. Number pronunciation guide**

Numeral	Spoken As	Numeral	Spoken As
0	ZE RO	5	FIFE
1	WUN	6	SIX
2	TOO	7	SEV EN
3	TREE	8	AIT
4	FOW ER	9	NIN ER



Table 113-571-1022-3. Prowords and associated meanings

Proword	Meaning
ALL AFTER	The portion of the message to which I have reference is all that which follows _____.
ALL BEFORE	The portion of the message to which I have reference is all that which precedes _____.
AUTHENTICATE	The station called is to reply to the challenge which follows _____.
AUTHENTICATIO N IS	The transmission authentication of this message is _____.
BREAK	I hereby indicate the separation of the text from other portions of the message.
CORRECT	You are correct, or what you have transmitted is correct.
CORRECTION	An error has been made in this transmission. Transmission will continue with the last word correctly transmitted.  An error has been made in this transmission (or message indicated). The correct version is _____. That which follows is a corrected version in answer to your request for verification.
DISREGARD THIS TRANSMISSION OUT	This transmission is in error. Disregard it. This proword shall not be used to cancel any message that has been of national/allied forces or populace, and which require immediate delivery.
INFO	The addresses immediately following are addressed for information.
I AUTHENTICATE	The group that follows it is the reply to your challenge to authenticate.
I READ BACK	The following is my response to your instructions to read back.
I SAY AGAIN	I am repeating transmission or portion indicated.
I SPELL	I shall spell the next word phonetically.
I VERIFY	That which follows has been verified at your request and is repeated. (To be used as a reply to verify.)
MESSAGE	A message which requires recording is about to follow (Transmitted immediately after the call.)
MORE TO FOLLOW OUT	Transmitting station has additional traffic for the receiving station.  This is the end of my transmission to you and no answer is required or expected. (Since OVER and OUT have opposite meanings, they are never used together.)

Table 113-571-1022-3. Prowords and associated meanings (continued)

Proword	Meaning
OVER	This is the end of my transmission to you and a response is necessary. Go ahead; transmit.
PRIORITY	Precedence PRIORITY. Reserved for important messages which must have precedence over routine traffic. This is the highest precedence which normally may be assigned to a message of administrative nature.
READ BACK	Repeat this entire transmission back to me exactly as received.
RELAY (TO)	Transmit this message to all addresses (or addresses immediately following this proword). The address component is mandatory when this proword is used.
ROGER	I have received your last transmission satisfactorily.
ROUTINE	Precedence ROUTINE. Reserved for all types of messages which are not of sufficient urgency to justify a higher precedence, but must be delivered to the addressees without delay.
SAY AGAIN	Repeat all of your last transmission. (Followed by identification data means "Repeat _____ (portion indication).")
SERVICE	The message that follows is a service message.
SILENCE	"Cease transmission immediately." Silence will be maintained until lifted. (Transmissions imposing silence must be authenticated.)
SILENCE LIFTED	Silence is lifted. (When an authentication system is in force, the transmission lifting silence is to be authenticated.)
SPEAK SLOWER	Your transmission is at too fast a speed. Reduce speed of transmission.
THIS IS	This transmission is from the station whose designator immediately follows.
TIME	That which immediately follows is the time or date/time group of the message.
TO	The addressee(s) immediately following is (are) addressed for action.
UNKNOWN STATION	The identity of the station with whom I am attempting to establish communications is unknown.

Table 113-571-1022-3. Prowords and associated meanings (continued)

Proword	Meaning
VERIFY	Verify entire message (or portion indicated) with the originator and send correct version. (To be used only at the discretion of the addressee to which the questioned message was directed.)
WAIT	I must pause for a few seconds.
WAITOUT	I must pause for longer than a few seconds.
WILCO	I have received your signal, understand it, and will comply. (To be used only by the addressee. Since the meaning of ROGER is included in that of WILCO, the two prowords are never used together.)
WORD AFTER	The word of the message to which I have reference is that which follows _____.

- e. Get a receipt for the message.
3. Leave the net in alphanumeric sequence.
- a. You receive a call from the NCS who issues a close down order (figure 113-571-1022-3).

NET THIS IS E3E (NCS) CLOSE DOWN OVER  
 E3E (NCS) THIS IS E13 (1<sup>st</sup> position) ROGER OUT  
 E3E (NCS) THIS IS E39 (2<sup>nd</sup> position) ROGER OUT  
 E3E (NCS) THIS IS E46 (3<sup>rd</sup> position) ROGER OUT

Figure 113-571-1022-2. Sample net call (close down)

- b. Answer in alphanumeric sequence.

**Note:** The NCS acknowledges and the net is closed. **Note:** The following call signs are used in this task as an example: Net call sign—E3E, NCS—E46, S-1—E39, S-2—E13.

**Evaluation Preparation:** *Setup:* Position operational radio sets in different rooms or tents or at least 70 feet apart outside. Obtain call signs, suffixes, and a radio frequency through the normal command chain. Select a message 15 to 25 words in length, containing some number groups such as map coordinates and times. Print the call signs for the sender and the receiver, along with the message to be sent, on 5 x 8 cards. Perform a communications check to ensure operation of the radios. Have an assistant who is proficient in radio operation man the NCS. Provide the assistant with the call signs. If the Soldier has not demonstrated sufficient progress to complete the task within 5 minutes, give him/her a NO GO. This time limit is an administrative requirement, not a doctrinal one; so if the Soldier has almost completed the task correctly, you may decide to allow him/her to finish.

*Brief Soldier:* Give the Soldier to be tested the card containing the message and call signs. Tell him/her that the radio is ready for operation, the net is considered to be secure and authentication is not required, and to send the message to the NCS and get a receipt. Tell the Soldier, if sufficient progress in completing the task within 5 minutes has not been demonstrated, he/she will receive a NO GO for the task.

Performance Measures	GO	NO GO
1. Entered the net in alphanumeric sequence.	_____	_____
2. Sent a message of 15 to 25 words using the correct prowords and phonetic alphabet and numerals.	_____	_____
3. Left the net in alphanumeric sequence.	_____	_____

**Evaluation Guidance:** Refer to chapter 1, paragraph 1-9e, (1) and (2).

**References**

**Required:** FM 24-18

**Related:**

## 113-587-1064

### Prepare SINGARS (Manpack) for Operation

**Conditions:** Given an operational single-channel ground and airborne radio system (SINGARS) manpack radio with battery box CY-8323A/B, battery, antenna AS-3683, handset H-250, carrying case, and TM 11-5820-890-10-8.

**Standards:** Correctly install the battery, preset the function controls for operation, mount the radio in the backpack, and correctly connect the accessories.

Performance Steps
-------------------

1. Install the battery.
  - a. Install one battery used for the main power in the SIP radio (rechargeable, BB-390 A/U battery, rechargeable, BB-590/U or nonrechargeable, BB-5590/U (Lithium).
  - b. Connect the battery case to the radio set. (Refer to TM 11-5820-890-10-8, page 2-14.)
2. Assemble the radio and the pack frame. Assemble the pack and fasten the assembled radio into the carrying case. (Refer to TM 11-5820-890-10-8.)
3. Install the antenna. Connect the AS-3683/PRC to the radio. (Refer to TM 11-5820-890-10-8, page 5-3.)
4. Connect the handset H-250. Connect the handset H-250/U or handheld remote control radio device (HRCRD) (C-12493/U). (Refer to TM 11-5820-890-10-8, page 3-12.)
5. Preset function controls. (Refer to TM 11-5820-890-10-8, page 5-1.)

Performance Measures	GO	NO GO
1. Installed the batteries.	_____	_____
2. Assembled the radio and pack frame.	_____	_____
3. Installed the antenna.	_____	_____
4. Connected the handset H-250/U.	_____	_____
5. Preset the function controls.	_____	_____

**Evaluation Guidance:** Refer to chapter 1, paragraph 1-9e, (1) and (2).

### References

**Required:** TM 11-5820-890-10-8

**Related:** TM 11-5820-890-10-1 and TM 11-5820-890-10-3

## 113-587-2070

### Operate SINCGARS Single-Channel (SC)

**Conditions:** Given an operational single-channel ground and airborne radio system (SINCGARS), KYK-13/TSEC with keys or AN/CYZ-10, C-11291 CM, distant station, TM 11-5820-890-10-8, TM 11-5820-890-10-3, TM 11-5820-890-10-1, ACP 125 US Suppl-1, DA Pam 738-750, FM 24-19, FM 24-18, and unit signal operation instructions (SOI) or ANCD with SOI data loaded.

**Standards:** Conduct a secure communications check in single channel (SC) mode with a distant station and change the radio functions using the control monitor.

#### Performance Steps

1. Perform starting procedures.
2. Load the traffic encryption key (TEK).
3. Enter the net.
  - a. Use the correct procedures.
  - b. Conduct a secure communications check
4. Prepare the control monitor for operation.
5. Change the radio functions using the control monitor.
6. Exit the net.
7. Perform stopping procedures.

**Evaluation Preparation:** *Setup:* Ensure that the radio set is complete and operational with (CM) installed on the radio.

*Brief Soldier:* Tell the Soldier all performance measures must be completed correctly within 20 minutes. All performance measures must be done in sequence.

Performance Measures	GO	NO GO
1. Performed starting procedures.	_____	_____
2. Loaded the TEK.	_____	_____
3. Entered the net.	_____	_____
a. Used the correct procedures.	_____	_____
b. Conducted a secure communications check.	_____	_____
4. Prepared the control monitor for operation.	_____	_____
5. Changed radio functions using the control monitor.	_____	_____
6. Exited the net.	_____	_____
7. Performed stopping procedures.	_____	_____

**Evaluation Guidance:** Refer to chapter 1, paragraph 1-9e, (1) and (2).

**References**

**Required:** ACP 125 US SUPPL-1, DA Pam 738-750, FM 24-18, FM 24-19, TM 11-5820-890-10-1, TM 11-5820-890-10-3, TM 11-5820-890-10-8, and Unit SOI

**Related:**

## 113-600-2001

### Communicate Via a Tactical Telephone

**Conditions:** Given a requirement to communicate a message via a tactical telephone and the following:

1. An unclassified message (approximately 25 words in length).
2. A tactical telephone (DNVT, TA-838/TT, TA-341/TT, TA-1042A/U and TA-954/TT) installed in a point-to-point configuration and operating in a nonsecure mode.
3. ACP 125 US Supp-1, and ACP 125(E).

**Standards:** Communicate a prepared message within 10 minutes without errors.

**Performance Steps**

1. Initiate call (lift the handset from the cradle).
2. Verify that the distant end is ready to receive the message.
3. Communicate the message.
4. Verify that the message was received.
5. Disconnect the call (return the handset to the cradle).

**Evaluation Preparation:** *Setup:* Provide the Soldier with the following:

1. Ensure the tactical telephone (DNVT, TA-838/TT, TA-341/TT, TA-1042A/U and TA-954/TT) is installed and connected to the distant tactical telephone (DNVT, TA-838/TT, TA-341/TT, TA-1042A/U and TA-954/TT).
2. Ensure that both tactical telephones (DNVT, TA-838/TT, TA-341/TT, TA-1042A/U and TA-954/TT) are set to operate in the point-to-point mode.
3. Have a prepared message (approximately 25 words in length) for the Soldier to communicate.

*Brief Soldier:* Tell the Soldier that he/she must communicate the prepared message within 10 minutes without errors.

Performance Measures	GO	NO GO
1. Initiated the call (lifted the handset from the cradle).	_____	_____
2. Verified that the distant end was ready to receive the message.	_____	_____
3. Communicated the message.	_____	_____
4. Verified that the message was received.	_____	_____
5. Disconnected the call (returned the handset to the cradle).	_____	_____

**Evaluation Guidance:** Refer to chapter 1, paragraph 1-9e, (1) and (2).

#### References

**Required:** ACP 125 US Suppl-1 and ACP 125(E)

**Related:**

**SUBJECT AREA 7: SEE**

---

## 071-331-0804

### Perform Surveillance Without the Aid of Electronic Devices

**Conditions:** Given an enemy force equipped with wheeled and tracked vehicles, within range of sight or hearing during day and night.

**Standards:** Identify 50 percent of the enemy soldiers and vehicles within your field of view using proper surveillance techniques.

#### Performance Steps

1. Conduct a visual search in daylight.
  - a. Make a fast overall search of the entire area by raising your eyes quickly from just in front of your position to the maximum range you wish to observe (figure 071-331-0804-1). (For a wide area, subdivide and repeat the procedure.)



Figure 071-331-0804-1. Fast overall search

- b. Observe by overlapping, 50-meter-deep strips of terrain in detail, alternately searching left to right, right to left (figure 071-331-0804-2).

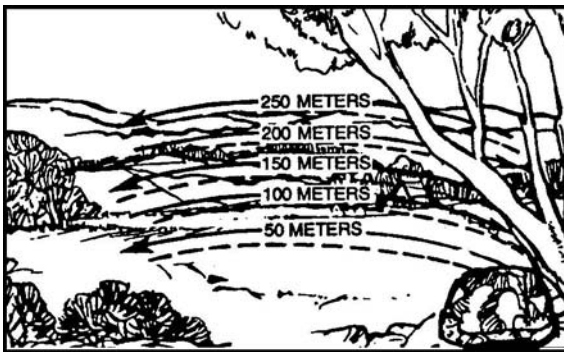

Figure 071-331-0804-2. Overlapping strip search

- c. Search suspicious spots thoroughly.
2. Identify improperly camouflaged personnel, equipment, and positions by looking for—
    - a. Camouflage or foliage that does not match.
    - b. Dead foliage.
    - c. Outlines that should be obscured.
    - d. Bright colors or reflections that should be subdued.
    - e. Tracks, footpaths, and piles of dirt and litter.
    - f. Over-clearing of fields of fire and observation.
  3. Conduct surveillance at night.
    - a. Accustom your eyes to low light before night operations by doing one of the following:



## Performance Steps

- (1) Stay in a secure, darkened area for 30 minutes such as an assembly area or initial rally point).
  - (2) Stay in a red-lighted area for 20 minutes, followed by 10 minutes in darkness.
  - (3) Wear red goggles for 20 minutes, followed by 10 minutes in darkness.
- b. Scan search areas at night by moving your eyes in short, quick, irregular movements (Figure 071-331-0804-3).

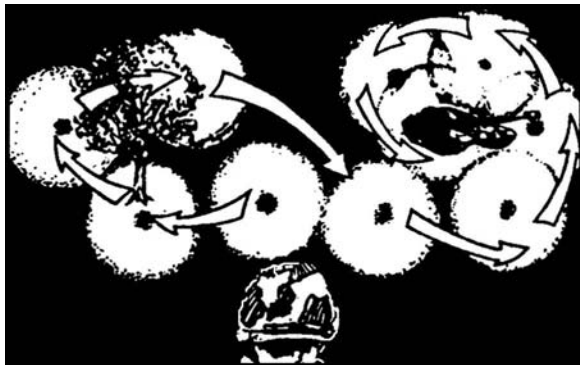

Figure 071-331-0804-3. Night vision search

- c. Use off-center vision to observe specific objects by looking about 6 to 10 degrees left, right, above, or below them (Figure 071-331-0804-4).

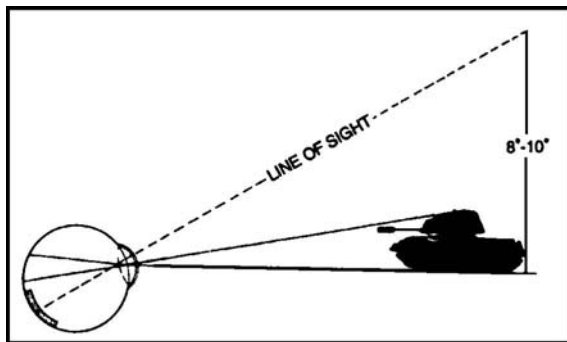

Figure 071-331-0804-4. Off-center vision

- d. Preserve night vision by—
- (1) Closing both eyes when exposed to bright light.
  - (2) Closing one eye only and observing with the other when surveillance must be maintained.
-

## Performance Steps

**Note:** Maintaining surveillance is one of the basic, critical combat skills. Because it is hard to tell if the above techniques are being used, frequent training is the only way to ensure mastery of this skill. This task is easy to integrate with other tactical training. In addition to the training in this task, frequent familiarization with the sounds of vehicles and weapons fire, with common smells (such as gasoline, campfires, and deodorants) in the field environment is recommended.

**Evaluation Preparation:** *Setup:* During a field exercise that involves camouflaging, have Soldiers conduct day and night surveillance. Simulate the following situations. Have each Soldier conduct surveillance at night and during the day before scoring him GO or NO GO:

1. Situation 1, day surveillance.
  - a. Improperly camouflaged enemy soldiers in fighting positions.
  - b. Stationary, properly camouflaged vehicles.
2. Situation 2, night surveillance. Moving and stationary enemy soldiers silhouetted on the skyline.

**Brief Soldier:** Tell the Soldier to conduct surveillance during the day and at night. During surveillance, the Soldier must locate 50 percent of the enemy soldiers within field of view and must differentiate between a tracked vehicle and a wheeled vehicle.

Performance Measures	GO	NO GO
1. Identified the following situations during daylight:  a. Fifty percent of improperly camouflaged enemy Soldiers in fighting positions.  b. A camouflaged wheeled vehicle and a tracked vehicle.	____	____
2. Identified the following situations during night surveillance:  a. Moving enemy Soldiers.  b. Stationary enemy Soldiers.	____	____

**Evaluation Guidance:** Refer to chapter 1, paragraph 1-9e, (1) and (2).

### References

**Required:** FM 21-75

**Related:**

---

## 071-730-0014

### Identify Combat Vehicles

**Conditions:** Given combat vehicles.

**Standards:** Identify combat vehicles by actual nomenclature.

## Performance Steps

1. Observe the vehicle.
2. Observe vehicle characteristics.
3. Compare observed vehicle characteristics with known vehicle attributes. Four areas of characteristics are used to identify vehicles. Most armored vehicles have all four areas of characteristics although not all vehicles do.
  - a. Track and suspension system. Many tanks can be recognized by their track and suspension systems. However, recognizing a vehicle by this feature alone is often difficult. Grass, dirt, terrain, dust, or other factors often obscure the tracks. To identify the track and suspension system, check to see whether it has support or return rollers. Few threat vehicles, except the T-10, T-64, T-72, BMD, BMP, SP-122, and SP-152, have either.
    - (1) Characteristics of most Warsaw Pact vehicles include a flat Christie suspension system, without support or return rollers, without torsion bars, and with unevenly spaced road wheels.
    - (2) Characteristics of most North Atlantic Treaty Organization (NATO) vehicles include a suspended track, support or return rollers, torsion bars, shock absorbers, and evenly spaced road wheels.
  - b. Turret. Most turrets can be grouped into three categories:
    - (1) Big bulky turrets—older models.
    - (2) Well sloped turrets—newer models.
    - (3) Streamlined turrets—newer models.
  - c. Main gun. Armament varies from machine guns to large cannons. In turreted vehicles, normally the heaviest armament is in the turret. Look for the main gun, the main gun bore evacuator, and its relative location on the main gun.
    - (1) Types of main guns:
      - (a) Smooth main gun without bore evacuator or blast deflector.
      - (b) Main gun with bore evacuator.
      - (c) Main gun with bore evacuator and muzzle brake or blast deflector.
    - (2) Types of muzzles:
      - (a) Single baffle.
      - (b) Double baffle.
      - (c) Multibaffle.
  - d. Cupolas. The cupola is a small, turret-like projection normally on top of the turret, which is used by the vehicle commander. It usually mounts a machine gun.
4. Eliminate any vehicle that lacks an observed, characteristic attribute.
5. Record the actual vehicle.

**Evaluation Preparation:** *Setup:* At the test site, provide the Soldier(s) with all equipment and materials needed for testing. Before evaluating the Soldier(s), check the computer/graphic training aid (GTA) media being used to ensure that it is operational. If using the ROC-V, check to ensure that the software has been loaded and set at the ready mode.

*Brief Soldier:* Read the following instructions to the Soldier(s): "At this time, you will be evaluated on your ability to identify combat vehicles. You must identify 28 out of 40 vehicles by actual nomenclature."

Performance Measures	GO	NO GO
1. Observed the vehicle.	___	___
2. Observed the vehicle characteristics.	___	___
3. Compared the observed vehicle characteristics with known vehicle attributes.	___	___
4. Eliminated any vehicle that lacked an observed characteristic attribute.	___	___
5. Recorded the vehicle.	___	___

**Evaluation Guidance:** Refer to chapter 1, paragraph 1-9e, (1) and (2).

**References**

**Required:**

**Related:** FM 3-23.24 (23-24), FM 3-90.1, and GTA 17-02-011

**SUBJECT AREA 8: HAND GRENADES AND LAND MINES**

**071-325-4401**

**Perform Safety Checks on Hand Grenades**

**Conditions:** Given any standard issue US hand grenade with extra safety clips and load-carrying equipment (LCE).

**Standards:** Inspect the grenade for defects; identify and correct defects, if possible. Report and turn in grenades that have defects you cannot correct. Identify each grenade by type, and correctly attach grenades to your ammunition pouch.

**Performance Steps**

1. Identify the grenades listed in table 071-325-4401-1 by type, color, markings, and usage.

Table 071-325-4401-1. Hand grenades

TYPE	COLOR/MARKINGS	USAGE
M67 Fragmentation	OD with yellow marking.	To disable or kill personnel. Will explode 4 to 5 seconds after the safety lever is released.
M18 Colored smoke	OD with color of smoke on top.	To signal personnel.
M34 WP Smoke	Light green, yellow band, red marking. *OLD MARKING* light gray, yellow band, yellow printing.	To signal personnel. Can produce casualties up to 35 meters away.
AN-M8 HC Smoke	Light green, black marking, white top.	To screen, "provide concealment."
AN-M14 TH3 Incendiary	Light red with black lettering.	To destroy equipment and start fires.
ABC-M25A2 CS Riot Control	Gray, red band(s) and markings.	To control riots or disable individuals without serious injury.

2. Inspect hand grenades for defects. Correct defects, if possible.
  - a. Check the fuse to ensure that it is screwed tightly onto the body of the grenade.
  - b. Check the safety clip to ensure that—
    - (1) It is present.
    - (2) It is in the correct position.
  - c. Replace safety clips (only if missing).
    - (1) Slide the clip onto the handle.
    - (2) Attach the loop portion of the clip around the fuse.
    - (3) Snap the clip end around the safety lever.
  - d. Check the safety pin.
    - (1) Ensure that the clip is in the correct position. If not, carefully push it into place while holding down the safety lever.
    - (2) Ensure that the clip is straight (not bent). If it is bent, carefully bend it back in position.
  - e. Check the safety ring for cracking. Reject any grenade that has a cracked safety ring.
  - f. Check the grenade for dirt. Wipe any dirty or grimy grenade clean with a cloth.
  - g. Turn in any defective grenade.

### WARNING

- Never attempt to modify a grenade.
- Never attempt to defuse a grenade.
- Never attempt to remove a grenade found upside down in its packing container.
- Never handle a dud grenade.
- Never attach grenades to clothing or equipment by the pull ring.

3. Attach the grenade to an ammunition pouch.

a. Attach the grenade to the new style pouch.

(1) Slip the grenade safety lever over the small strap sewn on each side of the ammunition pouch.

(2) Push the grenade down until it firmly seats against the side of the pouch.

(3) Ensure that the pull ring points downward.

(4) Wrap the carrying strap around the fuse, safety lever, and pull ring.

b. Attach the grenade to the old-style pouch.

(1) Slip the safety lever over the strap sewn on each side of the pouch. Push down the grenade until it firmly seats against the side of the pouch.

(2) Ensure the pull ring points downward, and wrap the carrying strap around the fuse, safety lever, and pull ring.

4. Check grenades occasionally while moving to ensure that the fuse is tight and the strap is secure.

---

**Evaluation Preparation:** *Setup:* Provide the following six inert hand grenades: M67 fragmentation grenade, M18 colored smoke grenade, M34 WP smoke grenade, AN-M8 HC smoke grenade, AN-M14 TH3 incendiary grenade, and the ABC-M25A2 CS riot-control grenade. The Soldier need not identify the grenades' alphanumeric nomenclature. Obtain several inert hand grenades, each with at least two of the following defects:

1. Fuze is unscrewed from the body of the grenade.
2. Safety clip is loose.
3. Safety pin is partially removed, bent, or both.
4. Safety pin is cracked.
5. Safety lever is broken.
6. Grenade is dirty.

Before testing the Soldier, ensure that you know the defects present in each grenade.

*Brief Soldier:* Tell the Soldier to identify each hand grenade; to inspect the grenade; and to correct the defects where possible. If the Soldier discovers a defect that

cannot be corrected, the Soldier must tell you the defect and that the grenade should be turned in. Tell the Soldier to attach a grenade to his/her ammunition pouch.

Performance Measures	GO	NO GO
1. Identified grenades.	___	___
2. Inspected the grenade.	___	___
3. Attached the grenade to the ammunition pouch.	___	___

**Evaluation Guidance:** Refer to chapter 1, paragraph 1-9e, (1) and (2).

#### References

**Required:**

**Related:** TM 9-1330-200-12

---

## 071-325-4407

### Employ Hand Grenades

**Conditions:** Given load-carrying equipment (LCE) and an offensive (concussion), riot-control, smoke, or incendiary grenade with a time-delayed fuze.

**Standards:** Throw the hand grenade to hit a target. Avoid exposing, and thus endangering, yourself for more than 5 seconds at a time.

#### Performance Steps

1. Position your body in a comfortable and natural position.
  - a. Make sure you are in a covered position.
  - b. Look at the target and judge the distance to the target.
  - c. Align your body with the target as if you were going to throw a football or baseball.

*Note:* This is body-target alignment.

2. Grip the hand grenade as follows:
  - a. Hold the safety lever down with your thumb.
  - b. Keep the pull ring and safety clip (if present) free, and face it towards your throwing hand.
3. Arm the grenade.
  - a. Remove the safety clip.

*Note:* Hold the safety lever down with your thumb. This keeps the pull ring and safety clip free and facing your nonthrowing hand.

4. Confirm your body-target alignment.
  - a. **TARGET:** Troops in the open. **EFFECTIVE ENGAGEMENT:** Within 5 meters of center.

## Performance Steps

- b.** TARGET: Troops with overhead cover. EFFECTIVE  
ENGAGEMENT: Inside the enclosure.
  - c.** TARGET: Troops dug in without overhead cover. EFFECTIVE  
ENGAGEMENT: Inside the position.
- 5.** Toss the grenade using an overhand movement. Release the grenade when it comes into your field of vision ensuring that you—
  - a.** Keep your eyes on the target.
  - b.** Follow through your throwing motion.
  - c.** Take cover, exposing yourself to fire for no more than 5 seconds.
- 6.** Return to the position behind cover until the grenade detonates, and avoid exposing yourself for more than 5 seconds at a time.
- 7.** Detonate the grenade within the effective bursting radius of the target.

**Evaluation Preparation:** *Setup:* At the test site, provide the Soldier with five dummy grenades to engage the targets. Provide targets of troops in the open, troops with overhead cover, or troops dug in without overhead cover.

*Brief Soldier:* Tell the Soldier to fasten four of the grenades to the ammunition pouches on his/her LCE and to hold one in his/her hand. Tell the Soldier that at least one grenade must detonate within the effective bursting radius of the target. Tell the Soldier not to expose his/her body for more than 5 seconds at a time.

Performance Measures	GO	NO GO
1. Positioned your body in a covered position, aligned as if to throw a football or a baseball.	___	___
2. Gripped the hand grenade, held down the safety lever with your thumb, kept the pull ring free, and faced your throwing hand.	___	___
3. Armed the grenade by removing the safety clip and the pulled ring.	___	___
4. Confirmed your body's target alignment by looking at the target.	___	___
5. Threw the grenade overhand while keeping your eyes on the target.	___	___
6. Returned to the position behind cover until the grenade detonated, and avoided exposing your body for more than 5 seconds at a time.	___	___
7. Detonated the grenade within the effective bursting radius of the target.	___	___



Performance Measures	GO	NO GO
<i>Note:</i> You will be scored a NO GO for a target only if you missed with all five grenades.		

**Evaluation Guidance:** Refer to chapter 1, paragraph 1-9e, (1) and (2).

**References**

**Required:** TM 9-1330-200-12

**Related:**

## 071-325-4425

### Employ an M18A1 Claymore Mine

**Conditions:** Given an M18A1 Claymore mine in a bandoleer, an M57 firing device, an M40 test set, and a firing wire with blasting cap, all packed in an M7 bandoleer; a sandbag; and two wooden stakes.

**Standards:**

1. Conduct a circuit test of the firing device, with the blasting cap secured under a sandbag.
2. Install the M18A1 Claymore mine so that—
  - a. The front of the mine centers on a kill zone.
  - b. The firing device is 16 meters to the rear or side of the emplaced mine and is fired from a covered position.
  - c. The mine, firing wire, and firing device are camouflaged.
  - d. The installation is confirmed by conducting a final circuit test.
3. When the target is in the kill zone, fire the mine by actuating the firing device handle with a firm, quick squeeze.

**Performance Steps**

1. Inventory and account for all accessories in the M18A1 Claymore mine bandoleer (figure 071-325-4425-1).

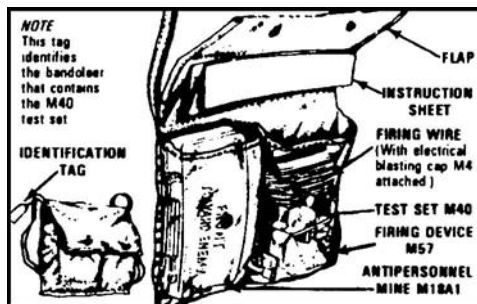

Figure 071-325-4425-1. Components of the M18A1 Claymore mine

**WARNING**

During testing and installation, keep the M57 firing device with you to keep anyone else from firing it accidentally.

## Performance Steps

2. Conduct a circuit test at the firing point (figure 071-325-4425-2).

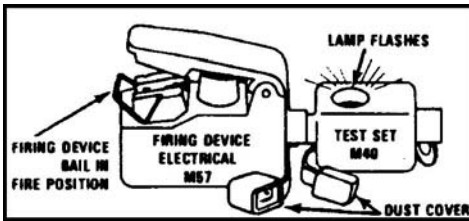

Figure 071-325-4425-2. Circuit test of the M57 firing device and M40 test set

- a. Remove the electrical wire and accessories while leaving the mine in the bandoleer.
- b. Remove the dust cover from the connector of the M57 firing device and from the female connector of the M40 test set.
- c. Plug the test set into the firing device.
- d. Position the firing device bail to the FIRE position.
- e. Activate the handle of the firing device with a firm, quick squeeze, observing the flash of light through the window of the test set.

**Note:** The flashing light indicates that the M57 firing device and M40 test set are functioning correctly

- f. Remove the shorting plug cover from the connector of the firing wire and from the end of the test set.
- g. Plug the connector of the firing wire into the test set (figure 071-325-4425-3).
- h. Place the blasting cap under a sandbag, behind a tree, or in a hole in the ground to protect the person performing the circuit check should the blasting cap detonate.

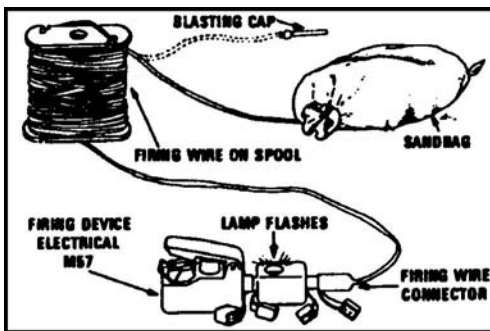

Figure 071-325-4425-3. Circuit test of the M18A1 Claymore mine firing system

## Performance Steps

i. Place the M57 firing device bail in the FIRE position and actuate the firing handle.

*Note:* The lamp in the window of the M40 test set should flash.

j. Place the firing device on SAFE; remove the firing device and the M40 test set.

k. Place the shorting plug cover on the firing wire.

3. Install the M18A1 Claymore mine.

a. Tie the shorting plug end of the firing wire to a fixed object such as a stake or tree at the firing position (figure 071-325-4425-4).

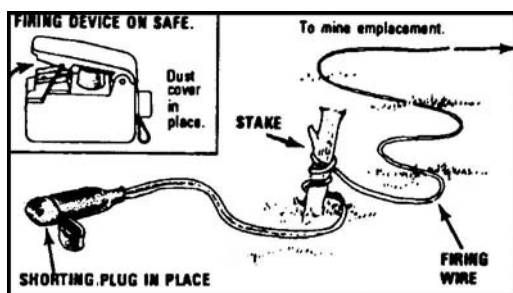

Figure 071-325-4425-4. Firing wire secured

b. Place the bandoleer on your shoulder.

c. Unroll the firing wire to the selected installation position.

d. Lay the firing wire from the firing position to the mine installation site, because the blasting cap end is on the inside of the firing wire spool.

4. Aim the mine.

a. Remove the mine from the bandoleer.

b. Open both pairs of legs to a 45-degree angle with two legs facing to the front and two legs facing to the rear of the mine (figure 071-325-4425-5).

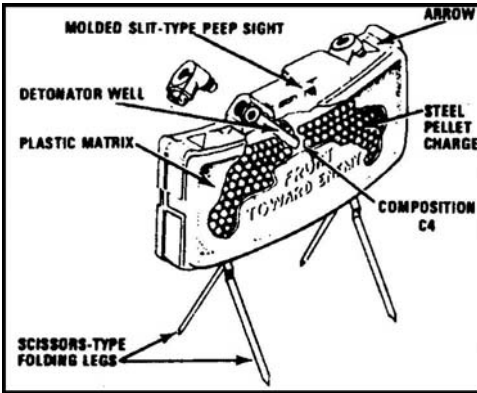

Figure 071-325-4425-5. Placing and aiming the mine

c. Push the legs about one-third of the way into the ground, with the mine facing in the desired direction of fire. In windy areas, or when the legs cannot be pressed into the ground, spread the legs as far as they will go (about 180 degrees) so that the legs are to the front and rear of the mine and the mine will not tip over.

d. Select an aiming point at ground level about 50 meters (150 feet) in front of the mine (figure 071-325-4425-6).

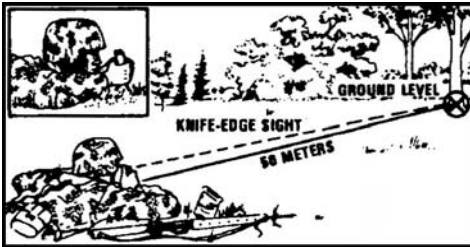

Figure 071-325-4425-6. Aiming knife-edge sight

e. Position one eye about 6 inches to the rear of the sight.

(1) On a knife-edge sight, align the two edges of the sight with the aiming point (figure 071-325-4425-7 and figure 071-325-4425-8).

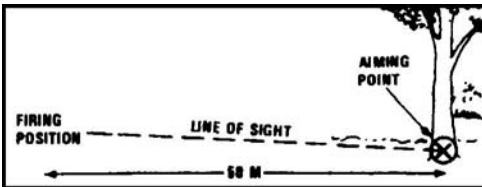

Figure 071-325-4425-7. Aiming knife-edge sight (continued)



Figure 071-325-4425-8. Aiming knife-edge sight (continued)

(2) On a slit-type peep sight, align the groove of the sight in line with the aiming point that is 2.5 meters (8 feet) off the ground (figure 071-325-4425-09 and figure 071-325-4425-10).



Figure 071-325-4425-9. Aiming slit-type peep sight

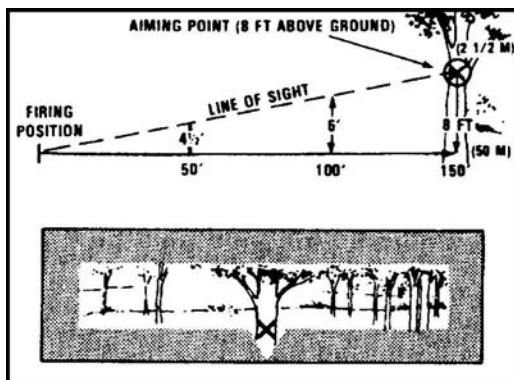

Figure 071-325-4425-10. Aiming slit-type peep sight (continued)

**Note:** The aiming point should be in the center of the desired area of coverage, with the bottom edge of the peep sight parallel to the ground that is to be covered with the fragment spray.

5. Arm the mine.
  - a. Secure the firing wire about 1 meter to the rear of the mine, so the mine will remain aligned if the firing wire is disturbed.
  - b. Unscrew one of the shipping plug priming adapters from the mine.

## Performance Steps

- c. Slide the slotted end of the shipping plug priming adapter onto the firing wire of the blasting cap between the crimped connections and the blasting cap.
- d. Pull the excess wire through the slotted end of the adapter until the top of the blasting cap is firmly seated in the bottom portion of the shipping plug priming adapter (figure 071-325-4425-11).

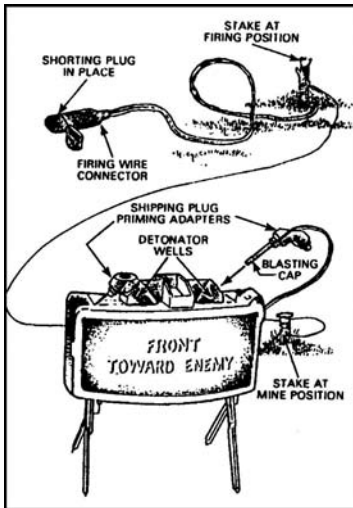

Figure 071-325-4425-11. Arming the mine

- e. Screw the adapter, with the blasting cap, into the detonator well.
  - f. Ensure that the face of the mine marked "front toward enemy" and the arrows on the mine point in the direction of the enemy.
  - g. Recheck the aim of the mine.
6. Camouflage the mine.
  7. Bury the firing wire (if possible) from the mine back to the firing position.
    - a. Ensure that the firing position is in a hole or covered position at least 16 meters to the rear or the side of the emplaced mine.
    - b. Use the M40 test set to test the circuit.
  8. Repeat step 2 to test the circuit after the firing wire is laid out and the cap is placed inside the mine. This is to see if any breaks in the wire have occurred (figure 071-325-4425-12).

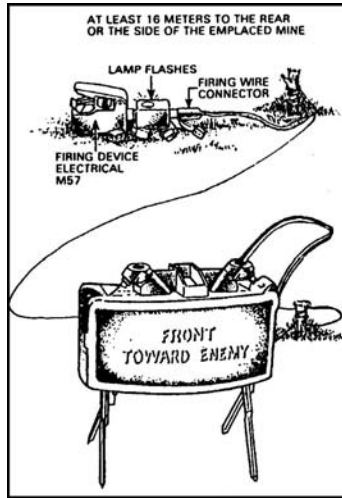

Figure 071-325-4425-12. Testing the circuit

a. To ensure that the mine will function properly after installation, test the firing circuit to check for any break in the wire that might have occurred during the installation. Any friendly troops within 250 meters to the front and sides or 100 meters to the rear of the mine must be under cover.

b. When retesting the circuit on a Claymore mine with the blasting cap inserted in the detonation well, remain behind cover or in a fighting position.

9. Fire the mine.

a. Remove the dust cover from the firing device and firing wire.

b. Connect the firing wire to the firing device.

c. Position the firing device safety bail in the FIRE position (figure 071-325-4425-13).

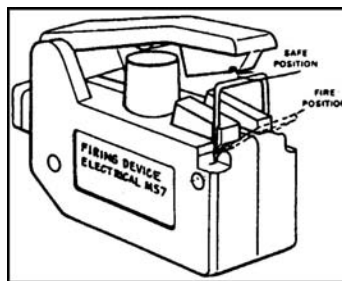

Figure 071-325-4425-13. Firing device in the FIRE position

d. Actuate the firing device handle with a firm, quick squeeze.

## Performance Steps

- e. Assume a prone position behind cover.

**Note:** The mine is most effective when employed against targets 20 to 30 meters in front of it.

**Evaluation Preparation:** *Setup:* During training, use only inert blasting caps and mines.

At the test site, place one M7 bandoleer containing an inert M18A1 Claymore mine, an M57 firing device, and an M40 test set. Make sure each mine is complete and serviceable.

Place one wooden stake in the ground at the test position and another at the mine-emplacement point. The distance between the emplacement point and firing point must be at least 16 meters. The stake at the aiming point should be painted red or some other distinguishable color.

Once the Soldier has emplaced the mine and completed the circuit test, assume a prone position and visually confirm that the mine is aimed correctly. To make this easier, place stakes 1 meter to each side of the aiming point stake. The stakes should be within 1 foot above the ground.

During the circuit test, avoid trying to observe the flash on the M40 test set. Doing so could interfere with the Soldier's performance.

Throughout the evaluation, if the Soldier says that he/she cannot see the flashing light, tell him/her, "Continue with the test."

**Brief Soldier:** Tell the Soldier to perform a circuit check on the firing wire and then install the mine. (Camouflaging and burying the wire are not covered in this evaluation.)

Performance Measures	GO	NO GO
1. Inventoried the M18A1 Claymore mine bandoleer, and ensured all components were present and in serviceable condition.	___	___
2. Tested the circuit.	___	___
3. Installed the M18A1 Claymore mine.	___	___
4. Aimed the mine.	___	___
5. Armed the mine.	___	___
6. Camouflaged the mine.	___	___
7. Buried the firing wire from the mine back to the firing position.	___	___
8. Retested the circuit.	___	___
9. Fired the M18A1 Claymore mine.	___	___

**Evaluation Guidance:** Refer to chapter 1, paragraph 1-9e, (1) and (2).



## References

**Required:** FM 23-23

**Related:**

---

## 071-325-4426

### Recover an M18A1 Claymore Mine

**Conditions:** Given an installed M18A1 Claymore mine, an M57 firing device, an M40 test set, a firing wire spool, an M7 bandoleer, and a requirement to remove an installed mine.

**Standards:** Recover the M18A1 Claymore mine, disarm it without activating the mine, and repack all components into the M7 bandoleer.

#### Performance Steps

1. Disarm the M18A1 Claymore mine.
  - a. Check the firing device safety bail to ensure it is on SAFE.
  - b. Disconnect the firing device from the wire.
  - c. Replace the shorting plug dust cover on the firing wire connector.
  - d. Replace the dust cover on the firing device connector.
  - e. Keep possession of the M57 firing device.

#### **WARNING**

While disarming and recovering the M18A1 Claymore mine, keep the M57 firing device with you.

- f. Untie the firing wire from the stake at the firing site.
  - g. Move to the M18A1 Claymore mine.
  - h. Remove the shipping plug priming adapter by unscrewing it from the blasting cap.
    - i. Separate the shipping plug priming adapter and the blasting cap.
    - j. Reverse the shipping plug.
    - k. Screw the shipping plug end of the adapter into the detonator well.
    - l. Remove the firing wire from the stake at the mine site.
    - m. Place the blasting cap into the end of the wire connector.
    - n. Roll the wire on the wire container.
2. Remove the M18A1 Claymore mine.
  - a. Lift the M18A1 Claymore mine from its emplacement.
  - b. Secure the folding legs.

### Performance Steps

- c. Repack the mine and all the accessories into the M7 bandoleer.

**Evaluation Preparation:** *Setup:* During training, use only inert blasting caps and mines.

*Brief Soldier:* Tell the Soldier to remove and install the mine. Camouflaging and burying the wire were not included during the evaluation.

Performance Measures	GO	NO GO
1. Disarmed the M18A1 Claymore mine.	_____	_____
2. Removed the M18A1 Claymore mine.	_____	_____

**Evaluation Guidance:** Refer to chapter 1, paragraph 1-9e, (1) and (2).

### References

**Required:**

**Related:** FM 23-23

## SUBJECT AREA 9: M16-SERIES RIFLE

### 071-311-2006

#### Construct Field-Expedient Firing Aids for an M16A1/A2 Rifle

**Conditions:** As a member of a squad in a defensive position, given an M16A1 or M16A2 rifle, a magazine and ammunition, sticks or rocks and boards available in the area, instructions on target location(s) within the individual's sector of fire, and left and right limits of the sector.

**Standards:** Properly emplace and align aiming and sector stakes on identifiable probable enemy avenues of approach, assault positions, and automatic weapons positions. Include left and right sector stakes to mark the sector of fire. When stakes are properly placed, they allow placement of rounds in selected target areas or positions. All fires are within the sector of fire.

### Performance Steps

*Note:* Use sector stakes to control the weapon within a sector of fire during limited visibility.

*Note:* Use aiming stakes to align a weapon on a known point or target during limited visibility.

1. Sector stakes. Sector stakes mark the left and right limits of your sector of fire (figure 071-311-2006-1).
  - a. Use tree limbs 1 to 1 ½ inches in diameter or pieces of an ammunition box about 18 inches long for the sector stakes.
  - b. Ensure that the stakes are sturdy; they must stick out of the ground far enough to keep you from pointing and firing your rifle out of the sector.
  - c. You must also drive the stakes far enough into the ground so the rifle will not knock them down if it hits them.

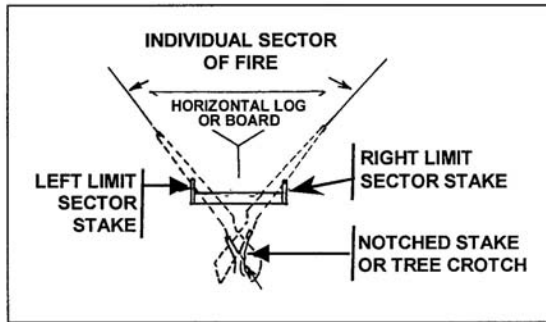

Figure 071-311-2006- 1. Sector stakes

2. Aiming stakes. During limited visibility, aiming stakes help in placing fire on avenues of approach or on specific targets.

a. Locate probable enemy positions or likely avenues of approach within your sector.

b. Select forked tree limbs 12 to 14 inches long.

c. Drive one stake into the ground near the edge of the fighting position. The stock of your rifle rests on this stake. The stake should be high enough to allow the rifle stock to fit comfortably against your shoulder.

d. Place additional stakes forward of the stock stake and align each with a target or avenue of approach. Firmly drive each stake into the ground. Adjust the stakes so that, in a firing position, when the rifle is placed on the stock and forward stakes, the fire will strike its intended target (figure 071-311-2006- 2). To fire, hold your shoulder firmly against the butt plate and the barrel in the aiming stakes.

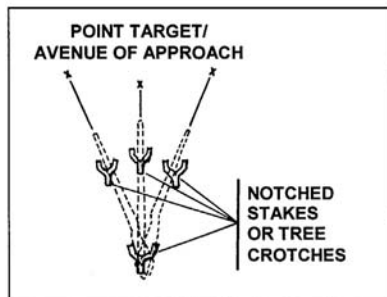

Figure 071-311-2006- 2. Aiming stakes

*Note:* The Soldier must hold the weapon in the exact position he/she held when positioning the stakes.

**Evaluation Preparation:** *Setup:* At the test site, provide a prepared fighting position, an M16A1 or M16A2 rifle, one magazine with ammunition, and forked stakes and sticks. Show the Soldier his/her sector of fire and the target(s) to be laid on.

*Brief Soldier:* Tell the Soldier to emplace the M16A1 or M16A2 rifle using the field-expedient method with the materials provided.

Performance Measures	GO	NO GO
1. Emplaced the sector stakes so the rifle could not be fired outside the assigned sector of fire, and so they could not be knocked down when touched with the rifle.	_____	_____
2. Emplaced the aiming stakes so each target was hit when the rifle was fired. The aiming stakes provided a stable rest for the rifle.	_____	_____

**Evaluation Guidance:** Refer to chapter 1, paragraph 1-9e, (1) and (2).

**References**

**Required:**

**Related:** FM 21-75 and TM 9-1005-317-10

## 071-311-2007

### Engage Targets with an M16-Series Rifle

**Conditions:** Given an M16-series rifle, magazines, ammunition, individual combat equipment, and stationary or moving targets (personnel or equipment) at engageable ranges.

**Standards:** Detect all stationary or moving targets within the assigned sector, use the proper search techniques with no more than 20 percent error, and determine the range to the target with no more than 20 percent error. Hit 60 percent or more of the targets in the assigned sector.

#### Performance Steps

1. Detect targets. Detecting targets depends on your position and skill in search and observation.

*Note:* You may not always be able to select your own position.

a. Select a position that provides—

(1) Natural cover and concealment.

(2) Good observation and fields of fire.

b. Perform a quick check upon taking a position by glancing quickly to specific points throughout your sector.

c. Perform a systematic search. If you do not identify activity during your quick check, search the terrain in overlapping strips (figure 071-311-2007-1).

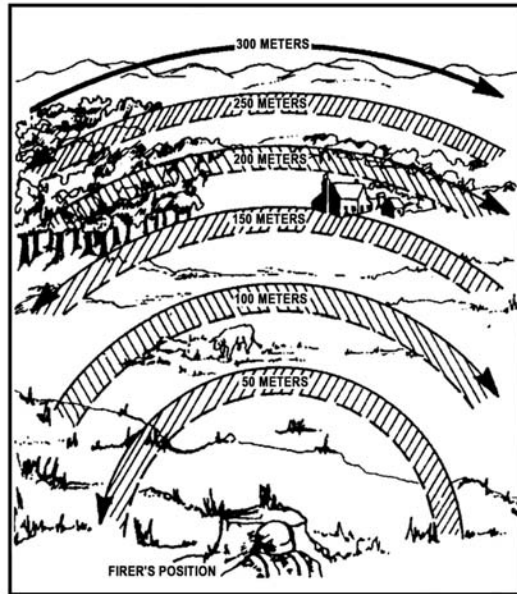

Figure 071-311-2007- 1. Searching the terrain in overlapping strips

- (1) Look for indications of targets such as—
  - (a) Sound. Sounds, such as footsteps, coughing, vehicles, and equipment noise, provide the general location of a target.
  - (b) Movement. Slow, deliberate movements are harder to detect than faster moving ones.
  - (c) Camouflage. The majority of targets on the battlefield are identified by missing or improper camouflage. Table 071-311-2007-1 shows the three areas of camouflage indicators.

Table 071-311-2007- 1. Camouflage indicators

CHARACTERISTIC	EXAMPLES
Shine-reflected light.	Metal objects such as belt buckles.
Regularity of outline.	Body, equipment, and vehicle outlines.
Contrast with background.	A soldier moving across various backgrounds.

- (2) Begin with either flank, focusing your eyes on specific points as you search the area (to take advantage of side vision).
- (3) Search a 180-degree arc, 50 meters in depth in front of your position.

## Performance Steps

(4) Begin searching a new arc upon reaching the end of the first arc. The second arc is 50 meters in depth and overlaps the first arc.

2. Determine the range to a target. Use your M16-series rifle to estimate the range. Viewed through the front sight, a man-sized target appears—

- a. Twice the width as the front sight post at approximately 90 meters.
- b. The same width as the front sight post at approximately 175 meters.
- c. Half the width of the front sight post at approximately 350 meters.

*Note:* You can use these proportions to estimate other ranges.

3. Assume the appropriate combat firing position. (Refer to table 071-311-2007-2.) Table 071-311-2007-2 lists the advantages and disadvantages of combat firing positions illustrated in figures 071-311-2007-2 through 071-311-2007-7.

POSITION	ADVANTAGES	DISADVANTAGES
FOXHOLE (Figure 2)	Best when available.	No overhead cover.
PRONE (Figure 3)	Steady, easy to assume, low silhouette, and easily adapted to use of cover and support.	Effectiveness can be limited by terrain and vegetation irregularities.
PRONE SUPPORTED (Figure 4)	Steadier than prone, other advantages the same as prone.	Same as prone.
KNEELING (Figure 5)	Used when firing from behind something, used on ground that is level or gently sloping upward.	Exposed to small arms fire.
KNEELING SUPPORTED (Figure 6)	Steadier than kneeling. Other advantage, the same as kneeling.	Exposure to small arms fire.
STANDING (Figure 7)	Used in assault to surprise targets or when other positions are not appropriate.	Exposure to small arms fire.

Table 071-311-2007-2. Firing positions



Figure 071-311-2007- 2. Foxhole position



Figure 071-311-2007-3. Prone position, not supported

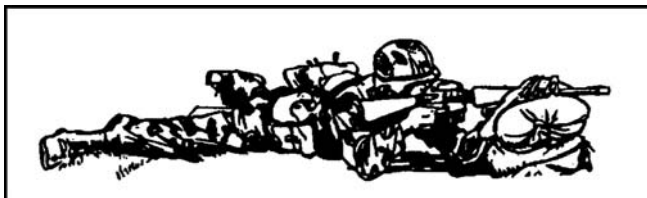

Figure 071-311-2007-4. Prone position, supported

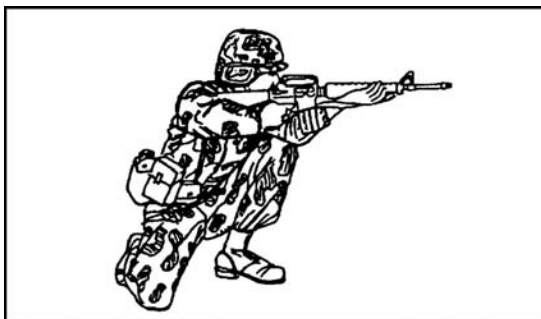

Figure 071-311-2007-5. Kneeling position, not supported

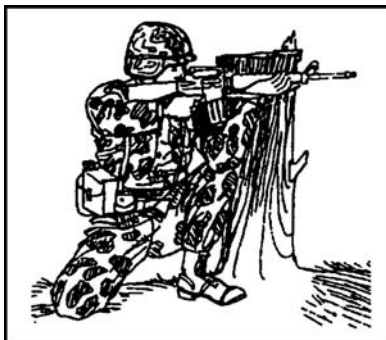

Figure 071-311-2007-6. Kneeling position, supported



Figure 071-311-2007-7. Standing position

4. Engage targets as soon as they are detected unless otherwise ordered.
  - a. Use the appropriate aiming technique.
    - (1) Engage a stationary target using reference points or sighting points.
    - (2) Engage a target moving towards you as you would a stationary target.
    - (3) Engage a target moving laterally using the new single-lead technique by placing the trailing edge of the front sight post at the center of the target. This method causes the lead to increase automatically as the range increases.
    - (4) Engage multiple targets (two or more) by first firing at the one presenting the greatest danger (usually the closest) and then rapidly proceeding to the next target.
  - b. Use the quick-fire technique when there is no time to properly aim. Use this technique on targets within 30 meters of your location. (This technique is most effective in urban terrain or heavy bush.)
    - (1) Use the standing position.
    - (2) Use the raised stock well looking 2 or 3 inches above the sights on a plane that is level with the barrel.
    - (3) Look at the target and NOT at the sights.
  - c. Aim the rifle at the target.
  - d. Fire the rifle.

---

**Evaluation Preparation:** *Setup:* Provide a live-fire range. Provide sufficient quantities of equipment and ammunition to support the number of Soldiers tested. Have each Soldier use his/her own rifle and magazine. Note that a separate range may be used to test the Soldier on target detection and range determination.

**Note:** You can train engagement skills using any and all rifle marksmanship training devices (for example, Weaponeer, Basic Rifle Marksmanship, DVC 07-57). The live-fire evaluation of a Soldier's ability to engage targets requires firing the standard rifle qualification course. The performance of this task for the common task



test (CTT) can be done in conjunction with live-fire on the standard rifle qualification course or during a unit weapon qualification firing cycle.

*Brief Soldier:* Tell the Soldier to detect and engage targets in his/her sector, and when asked, state the range to the target.

Performance Measures	GO	NO GO
1. Assumed a position that provided cover and concealment and good observation.	___	___
2. Completed a quick check of your sector within 30 seconds.	___	___
3. Detected all stationary and moving targets in your sector using the appropriate search technique with no more than 20 percent error.	___	___
4. Determined the range to each target with no more than 20 percent error.	___	___
5. Assumed the appropriate combat firing position.	___	___
6. Engaged all targets detected with the appropriate firing technique.	___	___
7. Hit at least 60 percent of the targets (24 of 40 on the standard qualification course range).	___	___

**Evaluation Guidance:** Refer to chapter 1, paragraph 1-9e, (1) and (2).

#### References

#### Required:

**Related:** FM 21-75, FM 3-22.9, FM 44-8, and TM 9-1005-249-10

## 071-311-2025

### Maintain an M16-Series Rifle

**Conditions:** Given an M16-series rifle, magazine, 5.56-mm ammunition, small arms maintenance equipment case, and lubricating instructions. You have the following cleaning materials: swabs, pipe cleaner; and cleaner, lubricant and preservative (CLP). You also have lubricating oil, semifluid, weapons; lubricating oil, arctic weapons; and a rifle bore cleaner.

**Standards:** Clean, inspect, and lubricate the rifle and magazine so that they function correctly; clean and inspect the ammunition; turn in any unserviceable ammunition.

#### Performance Steps

1. Clear the rifle.
  - a. Attempt to place the selector lever on SAFE. If the weapon is not cocked, the lever cannot be placed on SAFE (figure 071-311-2025-1).

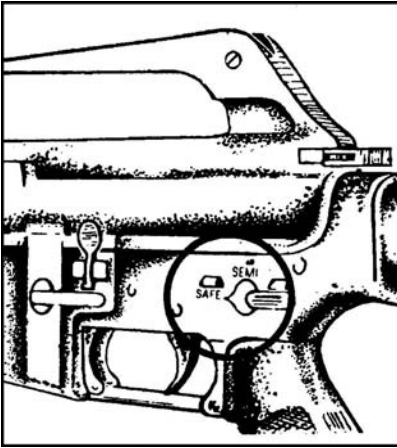

Figure 071-311-2025-1. Selector lever on SAFE

- b. Remove the magazine from the rifle, if there is one present.
- c. Lock the bolt open (figure 071-311-2025-2).

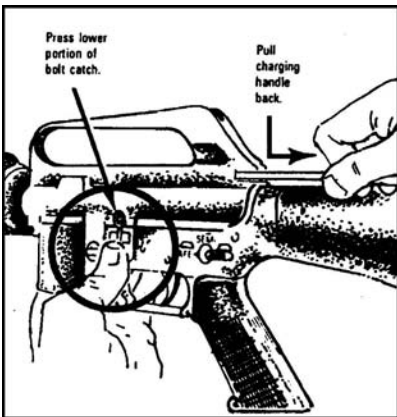

Figure 071-311-2025-2. Locking the bolt open

- (1) Pull the charging handle rearward.
  - (2) Press the bottom of the bolt catch.
  - (3) Allow the bolt to move forward until it engages the bolt catch.
  - (4) Return the charging handle to the forward position.
  - (5) If the selector lever is not on SAFE, place it on SAFE.
- d. Inspect the receiver and chamber to ensure they do not contain ammunition (figure 071-311-2025-3).

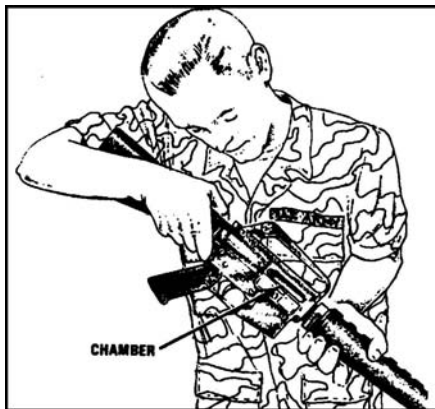

Figure 071-311-2025-3. Inspecting the chamber

- e. Allow the bolt to go forward by pressing the upper portion of the bolt catch (figure 071-311-2025-4).

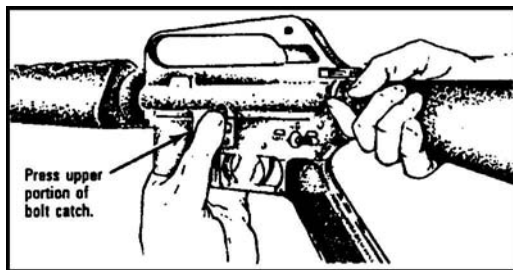

Figure 071-311-2025-4. Releasing the bolt

- f. Place the selector lever on SEMI and squeeze the trigger.
  - g. Pull the charging handle fully rearward and release it, allowing the bolt to go forward.
  - h. Place the selector lever on SAFE.
2. Disassemble the rifle.
- a. Verify the rifle is clear.
  - b. Remove the sling.
  - c. Remove the handguards only if you can see dirt or corrosion through the vent holes (figure 071-311-2025-5). Handguards on the M16A2 are interchangeable because they are identical.

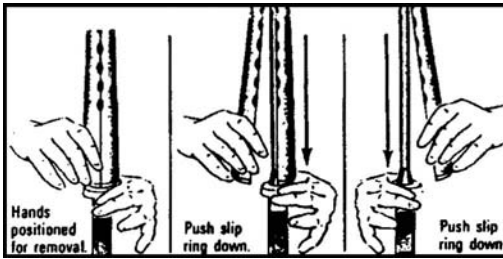

Figure 071-311-2025-5. Removing the handguards

**WARNING**

Avoid bending or denting the gas tube while removing the handguards.

- d. Push the takedown pin as far as it will go and pivot the upper receiver from the lower receiver (figure 071-311-2025-6).

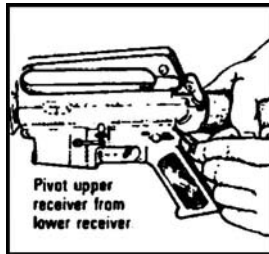

Figure 071-311-2025-6. Pushing the takedown pin

- e. Push the receiver pivot pin (figure 071-311-2025-7).

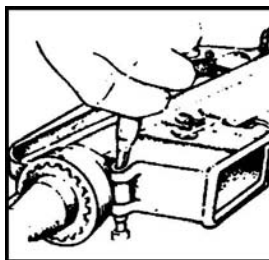

Figure 071-311-2025-7. Pushing the receiver pivot pin

- f. Separate the upper and lower receivers (figure 071-311-2025-8).

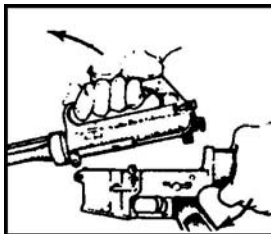

Figure 071-311-2025-8. Separating the upper and lower receivers

- g. Pull back the charging handle (figure 071-311-2025-9).

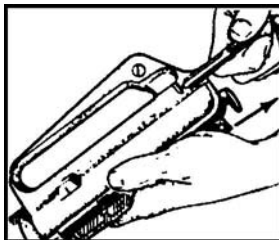

Figure 071-311-2025-9. Pulling the charging handle

- h. Remove the bolt carrier and bolt (figure 071-311-2025-10).

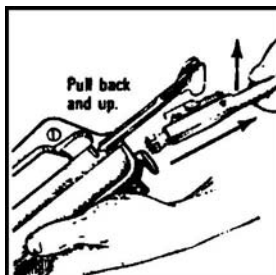

Figure 071-311-2025-10. Removing the bolt carrier and bolt

- i. Remove the charging handle (figure 071-311-2025-11).

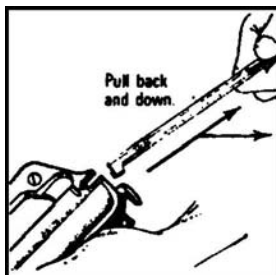

Figure 071-311-2025-11. Removing the charging handle

## Performance Steps

- j. Remove the firing pin retaining pin (figure 071-311-2025-12).

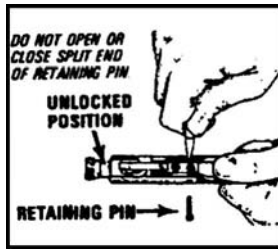

Figure 071-311-2025-12. Removing the firing pin retaining pin

- k. Put the bolt assembly in the locked position by pushing in the bolt (figure 071-311-2025-13).

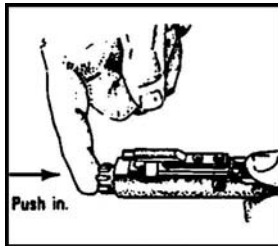

Figure 071-311-2025-13. Bolt in the locked position

- l. Remove the firing pin by allowing it to drop out of the rear of the bolt carrier into your hand (figure 071-311-2025-14).

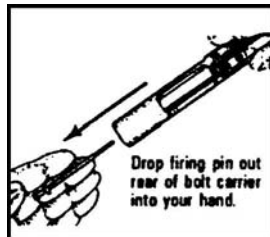

Figure 071-311-2025-14. Removing the firing pin

- m. Remove the bolt cam pin by turning it one-quarter turn and lifting it out (figure 071-311-2025-15).

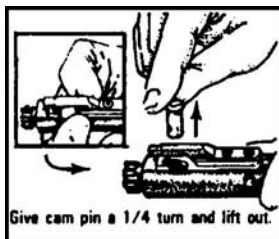

Figure 071-311-2025-15. Removing the bolt cam pin

- n. Pull the bolt assembly from the carrier (figure 071-311-2025-16).

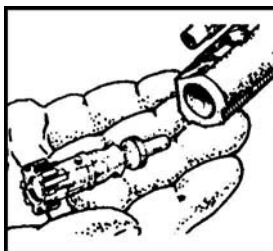

Figure 071-311-2025-16. Removing the bolt

*Note:* Perform steps o through r only when the parts are dirty or damaged.

- o. Remove the extractor pin by pushing it out with the firing pin (use care not to damage the firing pin) (figure 071-311-2025-17).

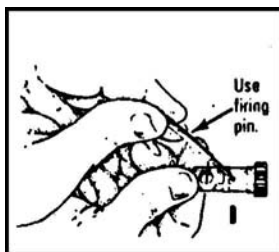

Figure 071-311-2025-17. Removing the extractor pin

- p. Lift out the extractor and spring (figure 071-311-2025-18), taking care so that the spring does not separate from the extractor.
-

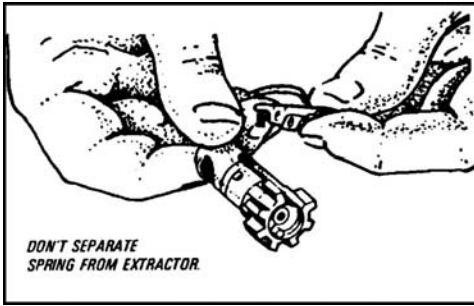

Figure 071-311-2025-18. Removing the extractor and spring

*Note:* Press the top of the extractor to check the spring function.

- q. Release the buffer by pressing the buffer and depressing the retainer.
- r. Remove the buffer and action spring separating the buffer from the spring (figure 071-311-2025-19 and figure 071-311-2025-20).

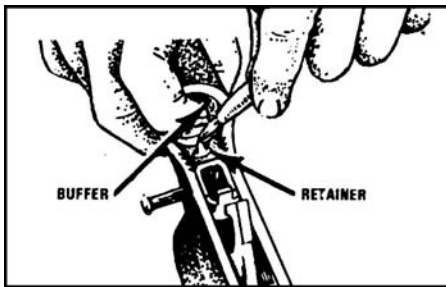

Figure 071-311-2025-19. Separating the buffer and spring



Figure 071-311-2025-20. Separating the buffer and spring (continued)

- s. Do not disassemble the rifle further.
3. Clean the rifle by removing carbon buildup and lubricating according to lubrication instructions. Make sure you remove any excessive oil from the bore before firing.

*Note:* After firing ball or blank ammunition, clean the weapon one time only with CLP. Under all but the coldest arctic conditions, use only CLP to lubricate the rifle.

- a. Clean the upper and lower receiver groups using CLP to remove powder fouling in the upper receiver (figure 071-311-2025-21).





Figure 071-311-2025-21. Cleaning the receivers

- b. Clean the bolt carrier group, wiping the following parts with swabs and other parts from the small-arms maintenance equipment case (figure 071-311-2025-22).

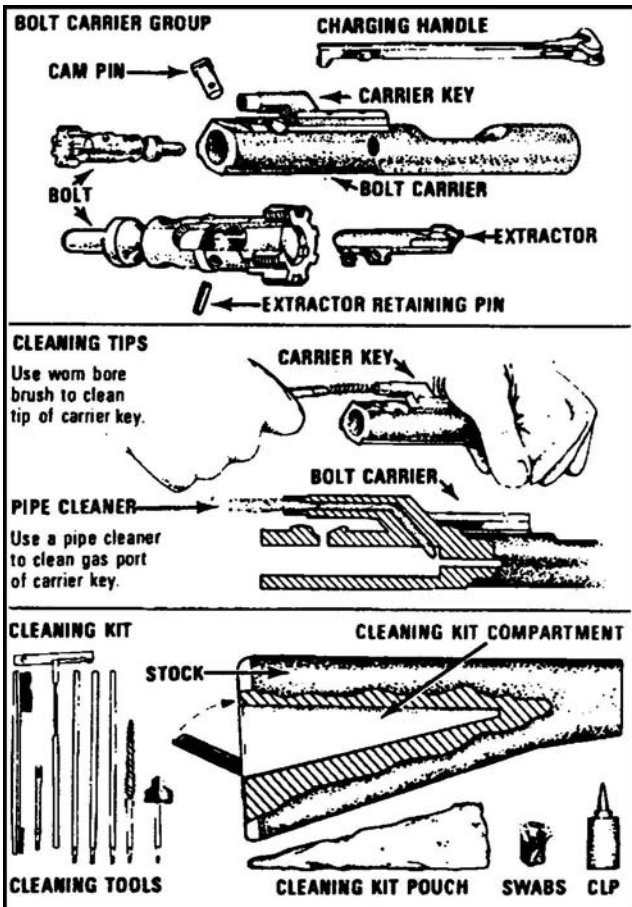

Figure 071-311-2025-22. Cleaning the bolt carrier group

- (1) The outer and inner surfaces of the bolt carrier.
- (2) The carrier key.
- (3) The firing pin recess and firing pin.
- (4) The firing pin hole with a pipe cleaner.
- (5) The carbon deposits and dirt from the locking lugs.
- (6) The areas behind the bolt ring and under the lip of the extractor.

c. Clean the following rifle parts lightly lubricating with CLP (figure 071-311-2025-22).

- (1) Lugs in the barrel extension, bore, and chamber.
- (2) Bolt carrier.
- (3) Slide cam pin area.
- (4) Piston rings.
- (5) Outside the bolt body.
- (6) Inside the bolt carrier key.

## Performance Steps

- (7) Firing pin and firing pin recess.
  - (8) Outside surface of the protruding gas tube with a worn bore brush.
  - (9) Buffer.
  - (10) Action spring.
  - (11) Inner surfaces of the lower receiver extension.
  - (12) Inside the lower receiver.
  - (13) All other components.
4. Inspect disassembled rifle bolt assembly (figure 071-311-2025-23).

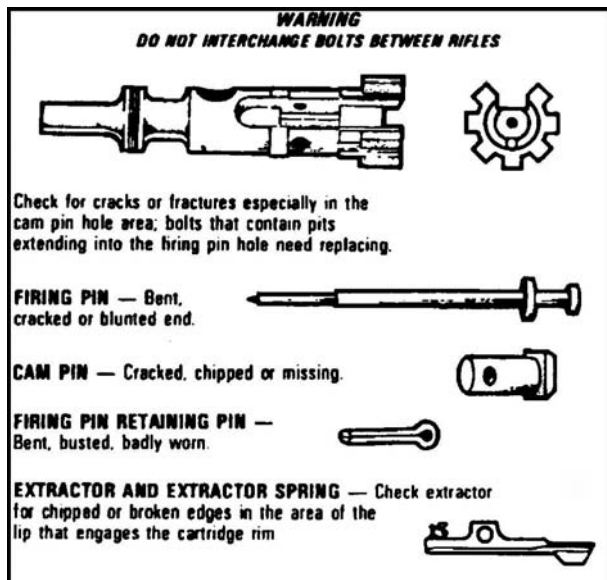

Figure 071-311-2025-23. Inspecting the bolt assembly

- a. Identify defective or missing components.
- b. Report deficiencies to the armorer.

## WARNING

Do not interchange bolts between rifles.

5. Assemble the rifle.
- a. Insert the spring and buffer (figure 071-311-2025-24).

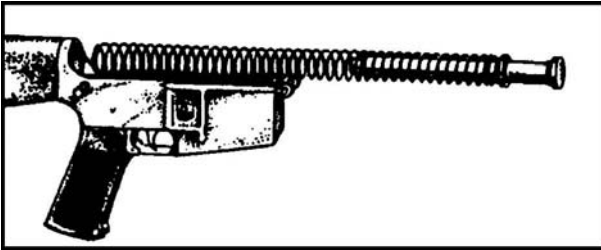

Figure 071-311-2025-24. Placing the spring and buffer

- b. Insert the extractor and spring (figure 071-311-2025-25).

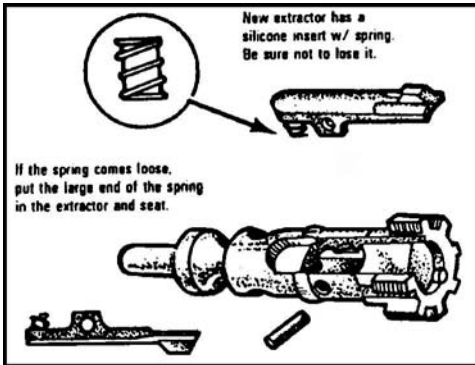

Figure 071-311-2025-25. Placing the extractor and spring

- c. Push the extractor pin in (figure 071-311-2025-26).

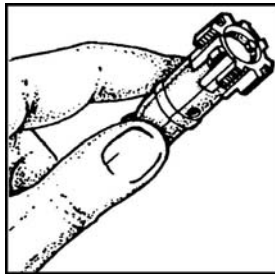

Figure 071-311-2025-26. Holding the extractor pin in

- d. Slide the bolt into the carrier until the bolt cam pin hole in both the bolt carrier and the bolt are aligned (figure 071-311-2025-27).
-

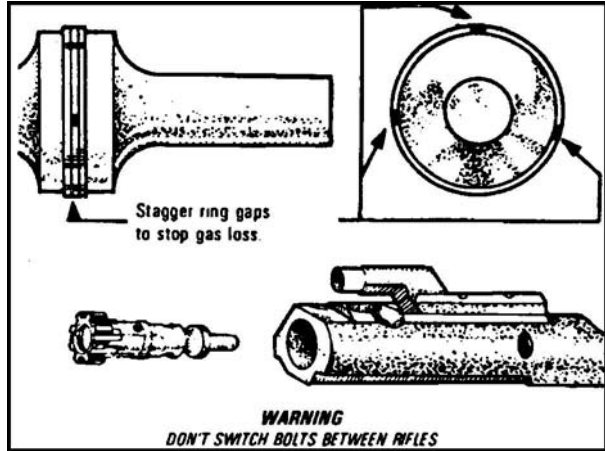

Figure 071-311-2025-27. Placing the bolt in the carrier

- e. Replace the bolt cam pin by putting it in the bolt carrier, turning it one-quarter turn (figure 071-311-2025-28).

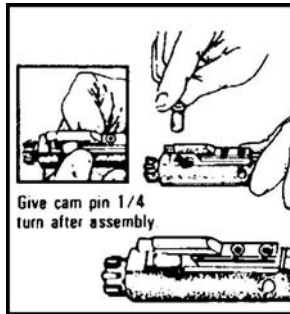

Figure 071-311-2025-28. Replacing the bolt cam pin

- f. Drop in the firing pin to seat it (figure 071-311-2025-29).

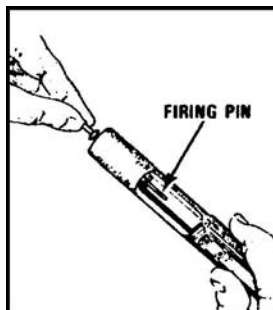

Figure 071-311-2025-29. Placing the firing pin

## Performance Steps

- g. Put the firing pin retaining pin in the bolt carrier to seat it (figure 071-311-2025-30).

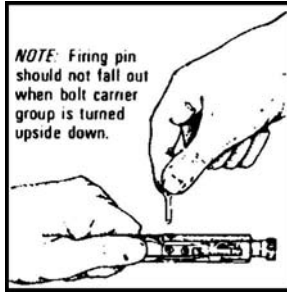

Figure 071-311-2025-30. Placing the firing pin retaining pin

- h. Pull the bolt back (figure 071-311-2025-31).

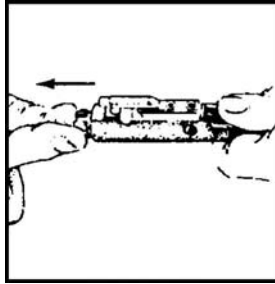

Figure 071-311-2025-31. Pulling back on the bolt

- i. Place the charging handle by engaging it, then pushing the charging handle part of the way in (figure 071-311-2025-32).

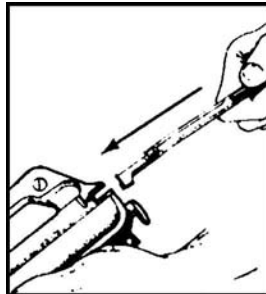

Figure 071-311-2025-32. Placing the charging handle in the receiver

- j. Slide the bolt carrier into the upper receiver (figure 071-311-2025-33).

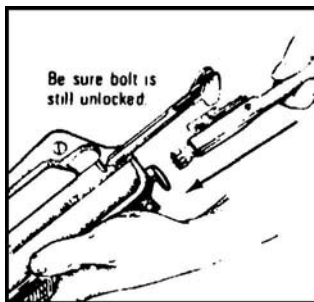

Figure 071-311-2025-33. Placing the bolt carrier

- k. Push the charging handle and bolt carrier together in the upper receiver (figure 071-311-2025-34).

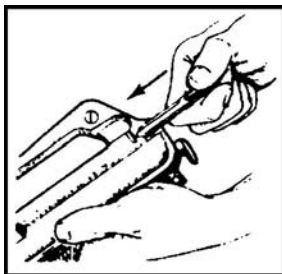

Figure 071-311-2025-34. Placing the charging handle and the bolt carrier

- l. Join the upper and lower receiver (figure 071-311-2025-35).

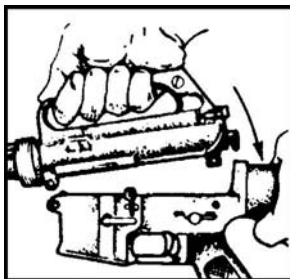

Figure 071-311-2025-35. Joining the upper and lower receivers

- m. Engage the receiver pivot pin (figure 071-311-2025-36).
-

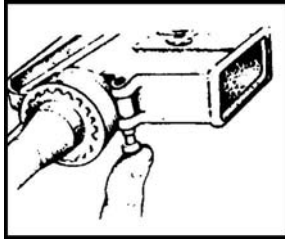

Figure 071-311-2025-36. Engaging the receiver pivot pin

**CAUTION**

The selector lever must be on SAFE before closing the upper receiver.

- n. Close the upper and lower receiver groups, seating the takedown pin and ensuring the selector switch is on SAFE (figure 071-311-2025-37).

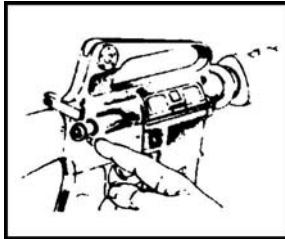

Figure 071-311-2025-37. Seating the takedown pin

- o. Put the handguards in place (figure 071-311-2025-38).

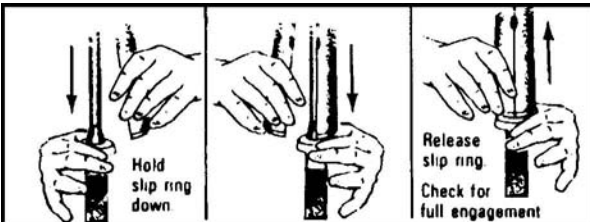

Figure 071-311-2025-38. Placing the handguards

- p. Replacing the sling (figure 071-311-2025-39).



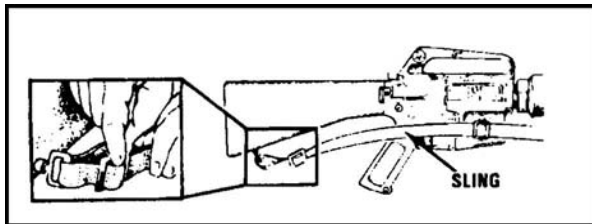

Figure 071-311-2025-39. Placing the sling

6. Disassemble the magazine without removing the follower from the spring.
  - a. Release the base catch (figure 071-311-2025-40).

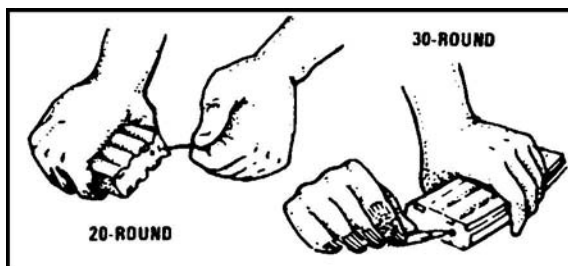

Figure 071-311-2025-40. Releasing the base catch of the magazine

- b. Remove the base (figure 071-311-2025-41).



Figure 071-311-2025-41. Removing the base of the magazine

- c. Remove the spring and follower by jiggling them (figure 071-311-2025-42).

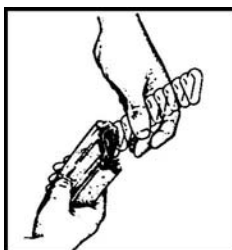

Figure 071-311-2025-42. Removing the magazine spring and the follower

## Performance Steps

7. Clean the magazine.
  - a. Wipe the dirt from the tube, spring, and follower.
  - b. Lubricate the spring lightly.
8. Assemble the magazine.
  - a. Jiggle the spring and follower together to install them in the magazine.
  - b. Slide the base under all four tabs, making sure that the print is on the outside.
9. Clean the ammunition using a clean, dry cloth to wipe dirt and foreign matter from the ammunition. Do not coat with oil.

**Evaluation Preparation:** *Setup:* Have Soldiers use their own rifles and magazines. Provide swabs, CLP, pipe cleaners, and, if available, preservative lubricant (PL), special lubricating oil, and rifle bore cleaner (RBC). (The Soldier should not select the PL, special lubricating oil, or RBC for use.) Also provide several rounds of dummy ammunition, if available.

*Brief Soldier:* Tell the Soldier to clean, inspect, and lubricate the rifle and magazine following normal safety practices.

Performance Measures	GO	NO GO
1. Cleared the rifle before disassembly.	___	___
a. Attempted to place the weapon on SAFE.		
b. Removed the magazine from the rifle.		
c. Locked the bolt open. (If not done so before, placed the weapon on SAFE.)		
d. Checked the receiver and chamber to ensure they did not contain ammunition.		
e. Allowed the bolt to go forward by pressing the upper portion of the bolt catch.		
2. Disassembled the rifle.	___	___
a. Verified that the rifle was clear.		
b. Removed the sling.		
c. Removed the handguards if you saw dirt or corrosion through the vent holes.		
d. Pushed the takedown pin as far as it would go and pivoted the upper receiver from the lower receiver.		
e. Pushed the receiver pivot pin.		

Performance Measures	GO	NO GO
<b>f.</b> Separated the upper and lower receivers.	<input type="checkbox"/>	<input type="checkbox"/>
<b>g.</b> Pulled back the charging handle.	<input type="checkbox"/>	<input type="checkbox"/>
<b>h.</b> Removed the bolt carrier and bolt.	<input type="checkbox"/>	<input type="checkbox"/>
<b>i.</b> Removed the charging handle.	<input type="checkbox"/>	<input type="checkbox"/>
<b>j.</b> Removed the firing pin retaining pin.	<input type="checkbox"/>	<input type="checkbox"/>
<b>k.</b> Put the bolt assembly in the locked position by pushing in the bolt.	<input type="checkbox"/>	<input type="checkbox"/>
<b>l.</b> Removed the firing pin by allowing it to drop out of the rear of the bolt carrier into your hand.	<input type="checkbox"/>	<input type="checkbox"/>
<b>m.</b> Removed the bolt cam pin by turning it one-quarter of a turn and lifting it out.	<input type="checkbox"/>	<input type="checkbox"/>
<b>n.</b> Pulled the bolt assembly from the carrier.	<input type="checkbox"/>	<input type="checkbox"/>
<b>o.</b> Removed the extractor pin by pushing it out with the firing pin.	<input type="checkbox"/>	<input type="checkbox"/>
<b>p.</b> Lifted out the extractor and spring, taking care so that the spring did not separate from the extractor.	<input type="checkbox"/>	<input type="checkbox"/>
<b>q.</b> Released the buffer by pressing the buffer and depressing the retainer.	<input type="checkbox"/>	<input type="checkbox"/>
<b>r.</b> Removed the buffer and action spring separating the buffer from the spring.	<input type="checkbox"/>	<input type="checkbox"/>
<b>3.</b> Cleaned the rifle using the correct materials.	<input type="checkbox"/>	<input type="checkbox"/>
<b>a.</b> Cleaned the upper and lower receiver group.	<input type="checkbox"/>	<input type="checkbox"/>
<b>b.</b> Cleaned the bolt carrier group.	<input type="checkbox"/>	<input type="checkbox"/>
<b>c.</b> Cleaned all of the other rifle parts and lubricated the rifle with CLP.	<input type="checkbox"/>	<input type="checkbox"/>
<b>4.</b> Inspected the rifle for unserviceable parts.	<input type="checkbox"/>	<input type="checkbox"/>
<b>a.</b> Identified the defective or missing components.	<input type="checkbox"/>	<input type="checkbox"/>
<b>b.</b> Reported deficiencies to the armorer.	<input type="checkbox"/>	<input type="checkbox"/>
<b>5.</b> Assembled the rifle.	<input type="checkbox"/>	<input type="checkbox"/>
<b>a.</b> Inserted the spring and buffer.	<input type="checkbox"/>	<input type="checkbox"/>
<b>b.</b> Inserted the extractor and spring.	<input type="checkbox"/>	<input type="checkbox"/>
<b>c.</b> Pushed the extractor pin in.	<input type="checkbox"/>	<input type="checkbox"/>

Performance Measures	GO	NO GO
d. Slid the bolt into the carrier until the bolt cam pin hole in both the bolt carrier and the bolt were aligned.		
e. Replaced the bolt cam pin by putting it in the bolt carrier, turning it one-quarter of a turn.		
f. Dropped in the firing pin to seat it.		
g. Put the firing pin retaining pin in the bolt carrier.		
h. Pulled the bolt back.		
i. Placed the charging handle by engaging it, then pushed the charging handle part of the way in.		
j. Slid the bolt carrier into the upper receiver.		
k. Pushed the charging handle and bolt carrier together in the upper receiver.		
l. Joined the upper and lower receiver.		
m. Engaged the receiver pivot pin.		
n. Closed the upper and lower receiver groups.		
o. Put the handguards in place.		
p. Replaced the sling.		
6. Disassembled the magazine without removing the follower from the spring.	_____	_____
a. Released the base catch.		
b. Removed the base.		
c. Removed the spring and follower.		
7. Cleaned the magazine.	_____	_____
a. Wiped the dirt from the tube, spring and follower.		
b. Lubricated the spring lightly.		
8. Assembled the magazine.	_____	_____
a. Jiggled the spring and follower together to install them in the magazine.		
b. Slid the base under all four tabs, ensured the printed portion was on the outside.		
9. Cleaned the ammunition.	_____	_____

**Evaluation Guidance:** Refer to chapter 1, paragraph 1-9e, (1) and (2).

## References

**Required:** GTA 07-01-039 and TM 9-1005-249-10

**Related:** FM 3-22.9

---

## 071-311-2026

### Perform a Function Check on an M16-Series Rifle

**Conditions:** Given an M16-series rifle that you must confirm is operable.

**Standards:** Perform a function check and ensure that the rifle operates properly with the selector switch in each position.

#### Performance Steps

1. Check an M16A1, M16A2, or M16A4 with the selector lever in the SAFE position (figure 071-311-2026-1).

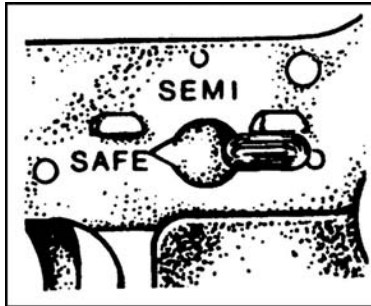

Figure 071-311-2026-1. Selector lever in the SAFE position

- a. Pull the charging handle to the rear and release it.
  - b. Place the selector lever in the SAFE position.
  - c. Pull the trigger (the hammer should not fall).
2. Check an M16A1, M16A2, or M16A4 with the selector lever in the SEMI position (figure 071-311-2026-2).

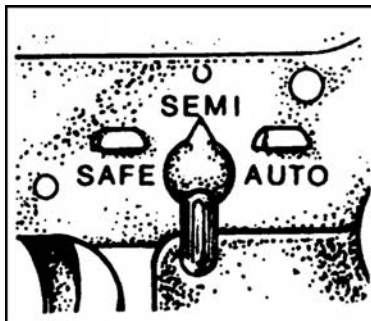
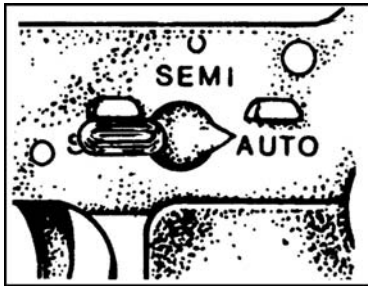

Figure 071-311-2026-2. Selector lever in SEMI position

## Performance Steps

- a. Place the selector lever in the SEMI position.
  - b. Pull the trigger, holding it to the rear (the hammer should fall).
  - c. Continue to hold the trigger to the rear while pulling the charging handle to the rear and releasing the charging handle.
  - d. Release the trigger with a slow, smooth motion until the trigger is fully forward (the hammer should not fall).
  - e. Pull the trigger (the hammer should fall).
3. Check an M16A1 with the selector lever in the AUTO position (figure 071-311-2026-3).



**Figure 071-311-2026-3. Selector lever in AUTO position**

- a. Place the selector lever in the AUTO position.
  - b. Pull the charging handle to the rear and release it.
  - c. Pull the trigger, holding it to the rear (the hammer should fall).
  - d. Continue to hold the trigger to the rear while pulling the charging handle to the rear and releasing the charging handle.
  - e. Release the trigger.
  - f. Pull the trigger (the hammer should not fall).
4. Check an M16A2 or M16A4 with the selector lever in the BURST position (figure 071-311-2026-4).
-

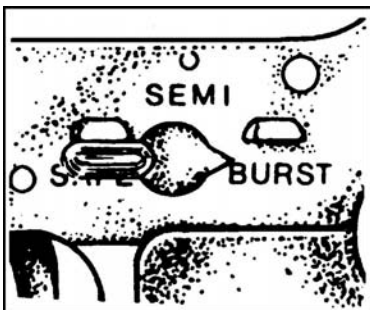

Figure 071-311-2026-4. Selector lever in the BURST position

- a. Place the selector lever in the BURST position.
  - b. Pull the charging handle to the rear and release it.
  - c. Pull the trigger, holding it to the rear (the hammer should fall).
  - d. Continue to hold the trigger to the rear while pulling the charging handle to the rear and releasing the charging handle.
  - e. Repeat step 4d twice.
  - f. Release the trigger.
  - g. Pull the trigger (the hammer should fall).
5. Stop the function check any time the rifle does not function properly.
  6. Turn in the malfunctioning rifle to the unit armorer.

**Evaluation Preparation:** *Setup:* Have Soldiers use their assigned rifles and magazines.

*Brief Soldier:* Tell the Soldier to perform a function check informing the evaluator if the rifle malfunctions.

Performance Measures	GO	NO GO
1. Checked an M16-series rifle with the selector lever in the SAFE position; verified the hammer did not fall.	___	___
2. Checked an M16-series rifle with the selector lever in the SEMI position; verified the hammer fell.	___	___
<i>Note:</i> Performed either step 3 or 4, as appropriate.		
3. Checked an M16A1 rifle with the selector lever in the AUTO position; verified the hammer did not fall.	___	___
4. Checked an M16A2 or M16A4 rifle with the selector lever in the BURST position; verified the hammer fell.	___	___

Performance Measures	GO	NO GO
5. Stopped the function check at any time the rifle did not function properly and notified the evaluator.	_____	_____

**Evaluation Guidance:** Refer to chapter 1, paragraph 1-9e, (1) and (2).

**References**

**Required:**

**Related:** TM 9-1005-249-10

## 071-311-2027

### Load an M16-Series Rifle

**Conditions:** Given an unloaded M16-series rifle and a magazine loaded with ammunition.

**Standards:** Load an M16A1 rifle in the semiautomatic and automatic modes; or, load an M16A2 or M16A4 rifle in both the semiautomatic and burst modes. Ensure that a round is chambered in the training weapon of your choice. Ensure that the selector switch is returned to the SAFE position.

#### Performance Steps

- Determine the mode in which the rifle will be operated by using table 071-311-2027-1.

**Table 071-311-2027-1. M16 family operating modes**

ONLY A1	BURST EQP WEAPONS	OPERATING MODE	SELECTOR POSITION	RIFLE WILL
X	X	Safe	SAFE	Not fire.
X	X	Semiautomatic	SEMI	Fire 1 round each time the trigger is pulled.
X		Automatic	AUTO	Fire as long as the trigger is held down or the ammo lasts.
	X	Burst	BURST	Fire a 3-round burst each time the trigger is pulled.

- Prepare the M16A1, M16A2, or M16A4 rifle for semiautomatic fire and the M16A1 rifle for automatic fire.
  - Point the rifle muzzle in a safe direction.
  - Cock the rifle (this also opens the bolt).
  - Return the charging handle to the forward position.
  - Place the selector lever on SAFE (figure 071-311-2027-1).



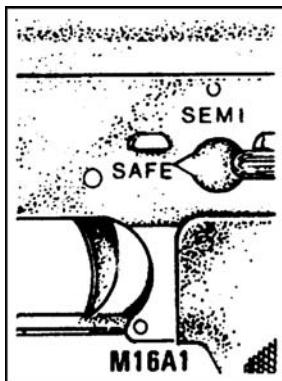

Figure 071-311-2027-1. Selector lever on SAFE

- e. Check the chamber to ensure it is clear (figure 071-311-2027-2).

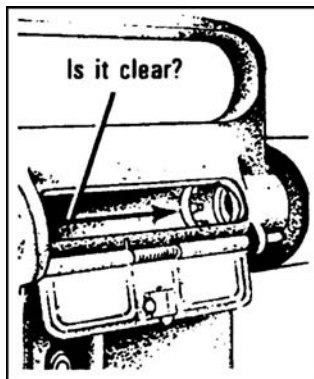

Figure 071-311-2027-002. Inspecting the chamber

- f. Insert the magazine, pushing it upward until the magazine catch engages and holds the magazine (figure 071-311-2027-3).
-

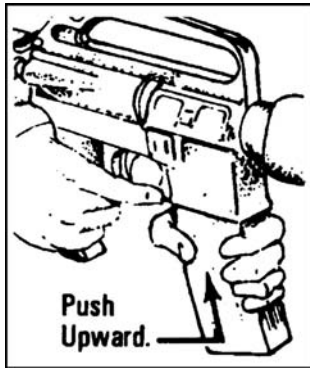

Figure 071-311-2027-3. Magazine inserted

- g. Tap upward on the bottom of the magazine to ensure it is seated.

*Note:* The magazine may be loaded with the bolt assembly open or closed.

3. Prepare the M16A2 or M16A4 rifle for burst fire.
  - a. Point the rifle muzzle in a safe direction.
  - b. Cock the rifle (this also opens the bolt).
  - c. Return the charging handle to the forward position.
  - d. Place the selector lever in the BURST position (figure 071-311-2027-4).

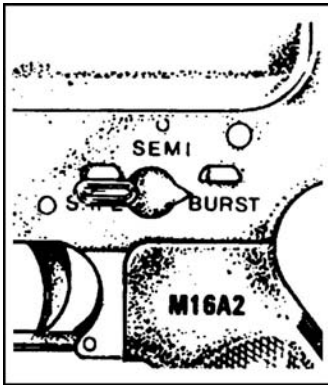

Figure 071-311-2027-4. Selector lever on BURST

- e. Pull the trigger, holding it in the rear position.
    - f. Pull the charging handle to the rear and release it (figure 071-311-2027-).

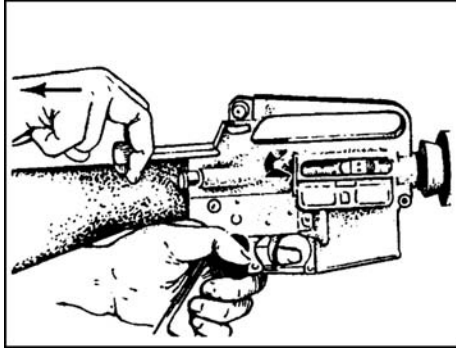

Figure 071-311-2027-5. Charging handle

- g. Repeat step 3f three times.
- h. Pull the charging handle to the rear, holding it in place.
- i. Release the trigger.
- j. Push in on the bottom portion of the bolt catch, locking the bolt in the rear position (figure 071-311-2027-6).

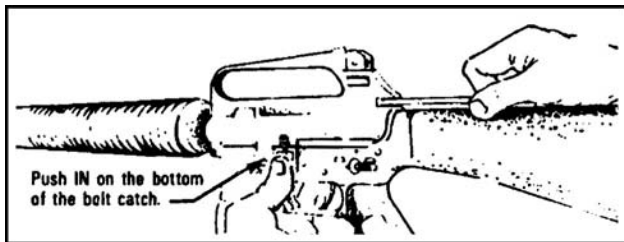

Figure 071-311-2027-006. Bolt locked to the rear

- k. Slide the charging handle all the way forward.
  - l. Place the selector on SAFE.
  - m. Insert the magazine. Push it upwards until the magazine catch engages and holds it (figure 071-311-2027-3).
  - n. Tap upward on the bottom of the magazine to ensure it is seated.
4. Chamber a round.
- a. With the bolt open—
    - (1) Depress the upper portion of the bolt catch to release the bolt (figure 071-311-2027-7).

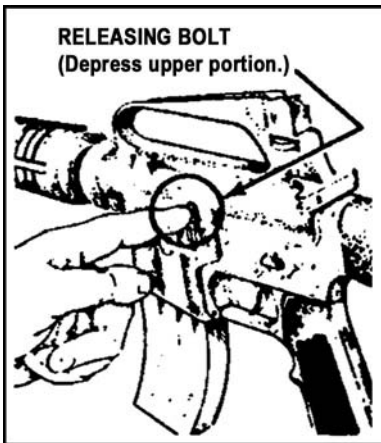

Figure 071-311-2027-7. Bolt catch

(2) Tap the forward assist to ensure that the bolt is fully forward and locked (figure 071-311-2027-008).

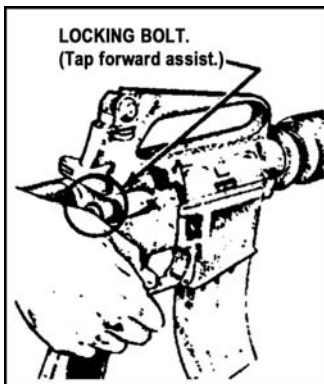

Figure 071-311-2027-8. Forward assist

**WARNING**

The rifle is now loaded. Ensure that it is pointed in a safe direction.

(3) Place the selector lever on SAFE. Close the ejection port cover if the rifle is not to be fired immediately.

b. With the bolt closed—

(1) Pull the charging handle to the rear as far as it will go.

(2) Release the charging handle. Do not ride the charging handle; allow it to return on its own.

(3) Tap the forward assist to ensure the bolt is fully forward and locked.

## Performance Steps

### WARNING

The rifle is now loaded. Ensure that it is pointed in a safe direction.

(4) Place the selector lever on SAFE. Close the ejection port cover if the rifle is not to be fired immediately.

**Evaluation Preparation:** *Setup:* Have Soldiers use their assigned rifles and magazines. Provide blank or dummy ammunition.

*Brief Soldier:* Tell the Soldier to load the rifle using the steps for the model used. Tell him/her that he/she must load an M16A2 rifle in both the semiautomatic and burst modes.

Performance Measures	GO	NO GO
<i>Note:</i> Perform steps 1 and 3 through 5 for the M16A1 rifle and steps 1 through 5 for the M16A2 or M16A4 rifle.		
1. Prepared the M16A1, M16A2, or M16A4 rifle for semiautomatic fire and the M16A1 rifle for automatic fire; ensured the chamber was clear and the magazine seated.	___	___
2. Prepared the M16A2 or M16A4 rifle for burst fire; ensured the magazine was seated.	___	___
3. Chambered a round; ensured the bolt is fully forward and locked.	___	___
4. Pointed the rifle in a safe direction.	___	___
5. Placed the selector lever in the SAFE position.	___	___

**Evaluation Guidance:** Refer to chapter 1, paragraph 1-9e, (1) and (2).

### References

#### Required:

**Related:** TM 9-1005-249-10 and TM 9-1005-319-10

## 071-311-2028

### Unload an M16-Series Rifle

**Conditions:** Given a loaded M16-series rifle from which you must remove the ammunition.

**Standards:** Clear the rifle, remove all ammunition, and secure the rifle in the SAFE mode.

## Performance Steps

1. Point the rifle muzzle in a safe direction.
2. Remove the magazine from the rifle.
3. Place the selector lever on SAFE.
4. Lock the bolt open.

## Performance Steps

- a. Pull the charging handle rearward.
  - b. Press the bottom of the bolt catch.
  - c. Return the charging handle to the forward position.
5. Remove any ammunition from the receiver and chamber.
  6. Press the upper portion of the bolt catch, allowing the bolt to go forward.
  7. Pull the trigger to release the pressure on the firing pin spring.

**Evaluation Preparation:** *Setup:* At a test site, provide an M16-series rifle loaded with dummy ammunition. (You can also evaluate the Soldier using his/her individual rifle if loaded. Do not require the Soldier to pull the trigger after releasing the bolt.)

*Brief Soldier:* Tell the Soldier to unload the rifle.

Performance Measures	GO	NO GO
1. Pointed the rifle muzzle in a safe direction.	___	___
2. Removed the magazine from the rifle.	___	___
3. Placed the selector lever on SAFE.	___	___
4. Locked the bolt open.	___	___
5. Removed any ammunition from the receiver and chamber.	___	___
6. Pressed the upper portion of the bolt catch, allowing the bolt to go forward.	___	___
7. Pulled the trigger to release the pressure on the firing pin spring.	___	___

**Evaluation Guidance:** Refer to chapter 1, paragraph 1-9e, (1) and (2).

### References

#### Required:

**Related:** TM 9-1005-249-10

## 071-311-2029

### Correct Malfunctions of an M16-Series Rifle

**Conditions:** Given a loaded M16-series rifle that has a malfunction and has stopped firing.

**Standards:** Eliminate the stoppage so that firing is resumed.

**WARNING**

If your rifle malfunctions with a live round in the chamber of a hot barrel, quickly remove the round. If you cannot remove the round within 10 seconds, remove the magazine and wait 15 minutes with the rifle pointed in a safe direction. Keep your face away from the ejection port while clearing a hot chamber to avoid possible injury from a cook off.

1. Perform immediate action.

*Note:* If your rifle malfunctions, remember S-P-O-R-T-S. This key word will help you remember these actions in sequence: slap, pull, observe, release, tap, shoot.

- a. Slap upward on the magazine to make sure it is properly seated.
- b. Pull the charging handle all the way back.
- c. Observe the ejection of the case or cartridge. Look into the chamber and check for obstructions.
- d. Release the charging handle to feed a new round into the chamber. Do not ride the charging handle.
- e. Tap the forward assist.
- f. Squeeze the trigger. If the rifle still does not fire, inspect it to determine the cause of the stoppage or malfunction and take appropriate remedial action.

2. Perform remedial action.

*Note:* If your rifle still fails to fire after performing steps 1a through 1f, check again for a jammed cartridge case in the chamber.

- a. Attempt to place the weapon on SAFE, remove the magazine, lock the bolt to the rear, and place the weapon on SAFE (if not already on SAFE).
- b. If a cartridge case is in the chamber, tap it out with a cleaning rod.

*Note:* If your rifle still fails to fire, the failure might be mechanical.

- c. Correct a mechanical malfunction.
  - (1) Clear the rifle.
  - (2) Disassemble the rifle.
  - (3) Inspect for dirty, corroded, missing, or broken parts.
  - (4) Clean dirty or corroded parts.
  - (5) Replace missing or broken parts.
  - (6) Assemble the rifle.
  - (7) Perform a function check.
  - (8) Load the rifle.
  - (9) Fire the rifle.

---

**Evaluation Preparation:** *Setup:* Provide an M16-series rifle loaded with dummy ammunition.

*Brief Soldier:* Tell the Soldier that the rifle has stopped firing, that the weapon is cool, and to perform the immediate and remedial actions on the rifle. Tell the Soldier he/she must perform all steps in the correct sequence.

Performance Measures	GO	NO GO
1. Performed immediate action.	___	___
2. Performed remedial action.	___	___

**Evaluation Guidance:** Refer to chapter 1, paragraph 1-9e, (1) and (2).

**References**

**Required:**

**Related:** FM 3-22.9 and TM 9-1005-249-10

**SUBJECT AREA 10: M240B MACHINE GUN**

**071-025-0001**

**Maintain an M240B Machine Gun**

**Conditions:** Given a cleared M240B machine gun; M122A1 tripod mount assembly; linked 7.62-mm ammunition; and a small arms case with the following items: cleaner, lubricant, and preservative (CLP); lubricating oil arctic weather (LAW); rifle bore cleaner (RBC); rags; pipe cleaners; chamber and bore brushes; cleaning rod; cleaning rags; small arms swabs; and an M240B scraper and reamer.

**Standards:** Clean and lubricate the M240B machine gun and components. Inspect all parts, components, and ammunition for serviceability; turn in unserviceable items to maintenance. Correctly assemble the gun and ensure that it is operational.

**Performance Steps**

1. Check to ensure that the weapon is clear.

**WARNING**

Be sure to clear the weapon before disassembling, cleaning, inspecting, transporting, or storing.

- a. Put the safety to "F."
  - b. Pull the cocking handle assembly to the rear, locking the bolt to the rear. Return the cocking handle to the forward position.
  - c. Place the safety to "S."
  - d. Push in the latches to open the cover assembly.
  - e. Remove the ammunition belt if present.
  - f. Raise the feed tray.
  - g. Inspect the chamber area. Remove any ammunition, ammunition casings, or links.
- (1) Check the feed pawl assembly and the feed tray assembly.



## Performance Steps

- (2) Lift the feed tray assembly and inspect the chamber.
  - (3) Check the space between the face of the bolt and the chamber.
  - (4) Check the space under the bolt and operating rod assembly.
- h.** Lower the feed tray.
  - i.** Place the safety to "F."
  - j.** Hold the cocking handle assembly to the rear, depress the trigger, and ease the bolt forward to close and lock.
  - k.** Close the cover assembly. Make sure that it locks shut.

**Note:** Be sure the bolt is forward with the safety in "F" (fire position) when the gun is not in use.

- 2.** Disassemble the M240B.

### WARNING

A hot barrel can burn you. If the barrel is hot, use your heat resistant mittens.

**Note:** The following steps do not have to be performed in sequence.

- a.** Remove the barrel assembly.
  - (1) Check to ensure that the bolt is forward.
  - (2) Depress the barrel locking latch and hold.
  - (3) Turn the barrel carrying handle to the upright position.
  - (4) Push forward and lift the barrel out.
- b.** Remove the heat shield assembly from the barrel. Lift the rear of the heat shield assembly from the barrel; pry the front tabs out of the holes on the gas hole bushing.
- c.** Remove the trigger-housing assembly.
  - (1) Depress the spring pin and remove it (this can usually be done without tools).
  - (2) Pull the trigger-housing assembly down and back and remove it.
- d.** Remove the buttstock and buffer assembly. Depress the backplate latch and lift the buttstock and buffer assembly straight up.
- e.** Remove the driving spring rod assembly.
  - (1) Push the driving spring rod assembly forward and up to disengage its retaining stud from the receiver.
  - (2) Pull rearward on the driving spring rod and remove it from the receiver.
- f.** Remove the bolt and operating rod assembly.
  - (1) Depress the cover latches and raise the cover assembly.
  - (2) Pull the cocking handle assembly back to move the bolt and operating rod assembly to the rear of the receiver.

## Performance Steps

(3) Reach into the receiver and push rearward on the bolt until the bolt and operating rod assembly are slightly out of the rear end of the receiver.

(4) Grasp the bolt and operating rod assembly and remove it from the receiver.

(5) Return the cocking handle to forward position.

g. Remove the cover assembly.

(1) Close the cover.

(2) Push out the spring pin as far as possible using the back plate of the buttstock or buffer assembly. Then remove it with your fingers.

(3) Depress the cover latches; lift up and remove the cover assembly.

(4) Remove the feed tray.

h. Remove the handguard.

(1) Extend the bipod legs to the down and locked position.

(2) Pull the handguard straight down and off of the gas cylinder.

### WARNING

Using gasoline, kerosene, hydraulic oil, benzene, benzol, high pressure water, steam, or air for cleaning is prohibited.

3. Clean the M240B parts, components, and ammunition.

### CAUTION

Do not use abrasives to clean the bore, piston, gas cylinder, or gas regulator plug. Do not submerge the buffer into any liquid. Wipe with a clean wiping rag only. Avoid getting CLP in the gas cylinder when cleaning the bore.

a. Use cleaning patches, CLP, and a bore brush to clean the bore.

b. Use CLP on the receiver brush bristles to clean the receiver.

c. Use rags and CLP to remove powder fouling, corrosion, dirt, and rust from all metal components and surfaces.

d. Use only a clean rag to clean the cover assembly.

e. Clean the gas cylinder.

(1) Use a gas cylinder cleaning brush dampened with CLP to clean the gas cylinder bore.

(2) Use a combination tool to clean the front interior of the gas cylinder.

(a) Insert the combination tool with the handle upward into the front end of the gas cylinder of the receiver body. Ensure the tool is fully inserted and seated against the gas cylinder.

(b) Apply slight pressure to the handles and turn clockwise to remove carbon.

f. Clean the gas regulator using the scraper and reamer.

## Performance Steps

(1) Insert the scraper into the central hole of the gas regulator plug. Remove carbon by twisting the scraper clockwise until it is fully seated against the gas regulator plug.

(2) Clean the regulator plug grooves by inserting the scraper tool into the grooves and turning the regulator plug clockwise.

(3) Insert the small reamer into each gas inlet hole and twist back and forth to remove carbon (use hand pressure only).

(4) Scrape carbon from the surface of the gas regulator plug using the tip of the scraper.

(5) Insert the large reamer through the hole in the gas port bushing into the gas port hole in the barrel; remove carbon by twisting the reamer back and forth until it enters the bore of the barrel.

**g.** Clean the M122A1 tripod assembly.

(1) Traversing and elevation (T&E) mechanism. Use a clean, dry wiping rag to remove foreign matter. Use a small arms cleaning brush to clean the numbers on the scale.

(2) Tripod assembly and flex mount. Use a cleaning rag saturated with a carbon-removing compound to clean. Wipe all parts dry with clean wiping rags.

**h.** Clean ammunition. Use a clean, dry wiping rag to remove foreign matter.

**4.** Inspect the M240B parts, components, and ammunition.

**a.** Barrel assembly.

(1) Check the barrel for bulges, bends, burrs, or pits in the chamber or bore.

(2) Check to ensure the flash suppressor is not loose.

(3) Check the front sight for damage and looseness.

(4) Check the barrel carrying handle assembly for damaged or missing parts. Move the barrel release slowly to the right and count the clicks. Fewer than two or more than seven clicks indicate defective parts.

(5) Check to ensure the heat shield is present, securely attached to the barrel, and undamaged.

**b.** Buttstock and buffer assembly.

(1) Check for burrs and rough edges on the mating grooves and flanges.

(2) Check the backplate latch to ensure it locks the buffer assembly securely.

(3) Check the buffer plug and ensure it sticks out through the backplate and is flush or higher than the protrusion below it.

(4) Shake to check the buffer for rattling sounds; use finger pressure to ensure the plug cannot rotate.

(5) Check the buttstock for cracks.

**c.** Driving spring rod assembly.

(1) Check the spring for broken strands.

## Performance Steps

(2) Check the rod assembly for bends.

**d.** Bolt and operating rod assembly.

(1) Inspect the bolt and operating rod assembly for bent, broken, cracked or missing parts. Check for burrs or pits on the surface.

(2) Check for cracks or wear on the tip of the firing pin.

(3) Ensure you cannot move the extractor with your fingers.

**e.** Trigger-housing assembly.

(1) Check for broken, missing, or damaged parts.

(2) Inspect the tripping lever and sear for burrs on edges.

(3) Check the cocking action by pushing back on the tripping lever (sear will rise). Pull the trigger (sear will lower).

(4) Check the safety. Place on "S" (safe) and pull the trigger. The sear should not drop down far enough to lock in the downward position. Place the safety on "F" (fire) and pull the trigger. The sear should drop down and lock in the downward position.

**f.** Cover assembly.

(1) Pivot the feed lever back and forth to ensure it operates smoothly without binding.

(2) Push in on the cover latches to make sure the retaining clip is present, secure, and does not bind in the housing.

(3) Push down on the cartridge guides and feed pawls to make sure the springs are present and secure.

(4) Inspect the accessory-mounting rail for nicks or burrs.

**g.** Feed tray. Check for cracks, deformation, broken welds, and loose rivets.

**h.** Handguard. Check for cracks, broken, or missing parts.

**i.** Receiver assembly.

(1) Check that the rear sight is securely mounted and operates properly.

(2) Check that the cocking handle operates properly.

(3) Check for damaged or missing ejection port cover, spring, and pin. Check for proper operation of the ejection port cover.

(4) Lower and raise the bipod legs to ensure they move freely without binding.

(5) Check the accessory-mounting rail for nicks or burrs that may prevent proper attachment of optional sighting devices.

(6) Check the barrel locking latch and cover detent for proper spring tension.

**j.** Components.

(1) T&E mechanism.

(a) Inspect the handwheels for smooth operation or rust.

## Performance Steps

- (b) Check the threads for burrs and rust.
- (c) Check the traversing slide lock for spring action. Ensure elevating mechanism sleeve fits on traversing bar and clamps firmly.
- (d) Check the traversing and elevating scales for legibility.
- (e) Inspect the quick-release pin and chain for burrs and rust. Check for missing spring-loaded balls.
- (2) Tripod assembly.
  - (a) Check for completeness of the tripod. Ensure that all nuts and bolts are tightly secured.
  - (b) Inspect for cracks on the legs and tripod head.
  - (c) Check for missing, broken, or inoperative lock latch.
  - (d) Check the pintle lock release cam for correct operation.
  - (e) Check the locking action of the front leg clamping assembly.
  - (f) Check that the rear legs lock in the open position. Ensure the sleeve latch notch and right leg slide notch engages completely. Ensure the latch spring has good tension.
  - (g) Check the telescoping, indexing, and locking action of rear legs and front leg locking assemblies.
- (3) Flexible mount assembly.
  - (a) Check for missing or damaged parts. Check for rust, cracks, and burrs.
  - (b) Inspect the pintle lock assembly for nut, bolt, and cotter pin. Check the pintle surface for burrs and rust.
- k. Inspect or check ammunition for damage and corrosion. Turn in any unserviceable ammunition.
- 5. Lubricate the M240B parts and components.
  - a. Generously lube the following parts:
    - (1) Barrel assembly—on the camming surfaces of the bolt-locking lugs.
    - (2) Operating rod—on the rollers, camming recess, and those surfaces immediately below the yoke that ride within the receiver rails.
    - (3) Cover—in the feed cam assembly.
    - (4) Bolt—on the bolt-locking lugs and actuator cam roller.
  - b. Lightly lube the following parts:
    - (1) Driving spring.
    - (2) Bolt and operating rod assembly moving parts, polished areas, firing pin, and roller.
  - c. Do not lubricate the following parts:

## Performance Steps

- (1) Buttstock.
- (2) Face of the bolt.
- (3) Piston.
- (4) Gas regulator and gas cylinder.
- (5) Rear sight.
- (6) Composite or rubber components.

d. Lightly lubricate all components and wipe with oily rag to remove excess oil.

### 6. Assemble the M240B.

#### a. Replace the barrel assembly.

(1) Insert the gas regulator plug into the gas hole bushing with the number 1 gas setting facing the barrel.

(2) Place the gas collar over the front end of the gas regulator plug. Rotate collar until it slips onto gas regulator plug. Press in and rotate counterclockwise to lock in place (pull collar to be sure it is in the locked position).

(3) Install the heat shield on the barrel. Insert the front metal tabs of the heat shield into the holes located on the sides of the gas hole bushing. Push down on the heat shield so that it snaps onto the barrel.

(4) With the gas regulator downward and the carrying handle in the vertical position, insert the barrel fully into the receiver socket and push the barrel carrying handle to the right as far as it will go to lock (fewer than two or more than seven clicks indicate defective parts). Do not force. If the barrel binds in the socket or if the barrel carrying handle will not rotate when pushed, do not pound on the barrel carrying handle. Take the machine gun to unit maintenance.

#### b. Replace the cover assembly and feed tray.

(1) Align the feed tray guides with the receiver brackets.

(2) Place the cover assembly onto the receiver with its mounting holes aligned with the mounting brackets on the receiver.

(3) Close the cover assembly. To secure the cover and feed tray to the receiver, insert the spring pin into the mounting holes from the right side only. Open the cover assembly. Check to ensure the cover detent holds the cover assembly open. If the cover assembly does not remain open in two positions, notify unit maintenance.

#### c. Replace the trigger housing assembly.

(1) Insert the holding notch on the trigger housing into the forward recess on the bottom of the receiver.

(2) Lift the trigger housing up and align the holes of the trigger housing with the mounting holes of the receiver.

(3) Hold the trigger housing in place and insert the spring pin.

#### d. Replace the bolt and operating rod assembly.

(1) Insert the bolt and operating rod assembly into the rear of the receiver. Ensure that the bolt is on top of the receiver rails.

## Performance Steps

- (2) Push the assembly into the receiver as far as possible. Pull the trigger and hold it while pushing the assembly all the way into the receiver.
  - (3) Close the cover assembly.
  - e. Replace the driving spring rod assembly.
    - (1) Insert the driving rod spring assembly all the way into the receiver.
    - (2) Push in and lower the driving rod spring assembly to seat the retaining stud in the hole on the bottom of the receiver.
  - f. Replace the buttstock and buffer assembly.
    - (1) Position the bottom recess grooves of the buttstock onto the top of the receiver recess grooves.
    - (2) Slide the buttstock down until it locks on the receiver. The top of the buffer should be flush with the top of the receiver.
7. Perform a function check to ensure the M240B is assembled correctly.

**Evaluation Preparation:** *Setup:* At the test site, provide all the equipment and materials listed in task condition statement. Use only dummy ammunition for training purposes.

*Brief Soldier:* Tell Soldier to perform maintenance on the M240B and linked 7.62-mm ammunition.

Performance Measures	GO	NO GO
1. Checked to ensure the weapon was clear.	___	___
2. Disassembled the M240B.	___	___
3. Cleaned the M240B parts, components, and ammunition.	___	___
4. Inspected the M240B parts, components, and ammunition.	___	___
5. Lubricated the M240B parts and components.	___	___

**Evaluation Guidance:** Refer to chapter 1, paragraph 1-9e, (1) and (2).

### References

#### Required:

**Related:** FM 3-22.68 and TM 9-1005-313-10

## 071-025-0002

### Perform a Function Check on an M240B Machine Gun

**Conditions:** Given a cleared M240B machine gun, bipod- or tripod-mounted.

**Standards:** Conduct a function check of the M240B machine gun; ensure it is correctly assembled and functions properly.

## Performance Steps

### WARNING

Before performing a task on any weapon, always check to ensure that the weapon is clear.

1. Place the safety lever to the "F" position.
2. Lock the bolt to the rear position by pulling the cocking handle to the rear.
3. Push the cocking handle to the forward position until it locks in the forward position.
4. Place the safety lever to the "S" position.
5. Depress the trigger; the bolt should not fall.
  - a. If the bolt falls, notify the supervisor. The machine gun is inoperative.
  - b. If the bolt does not fall, continue to the next step.
6. Place the safety lever to the "F" position.
7. Pull and hold the cocking handle to the rear.
8. While holding the cocking handle to the rear, depress the trigger, and ease the bolt to the forward and locked position.

**Evaluation Preparation:** *Setup:* At the test site, provide one M240B machine gun.

*Brief Soldier:* Tell the Soldier to perform a function check on the M240B machine gun.

Performance Measures	GO	NO GO
1. Placed the safety lever to the "F" position.	___	___
2. Locked the bolt to the rear position.	___	___
3. Pushed the cocking handle to the forward locking position.	___	___
4. Placed the safety lever to the "S" position.	___	___
5. Depressed the trigger.	___	___
6. Placed the safety lever to the "F" position.	___	___
7. Pulled and held the cocking handle to the rear position.	___	___
8. Depressed the trigger and eased the bolt to the forward and locked position.	___	___

**Evaluation Guidance:** Refer to chapter 1, paragraph 1-9e, (1) and (2).

### References

### Required:

**Related:** FM 3-22.68 and TM 9-1005-313-10



---

## 071-025-0003

### Load an M240B Machine Gun

**Conditions:** Given a cleared M240B machine gun (mounted on a bipod, tripod, or vehicle) and linked 7.62-mm ammunition.

**Standards:** Load linked ammunition in the feed tray groove so that when the cover is closed, a round remains in the tray groove and ammunition feeds correctly.

#### Performance Steps

1. Clear the weapon.
  - a. Place the safety to the "F" position.
  - b. Charge the weapon.
    - (1) Pull the cocking handle to the rear, locking the bolt in the rear position.
    - (2) Push the cocking handle to the forward and locked position.
  - c. Place the safety to the "S" position.
  - d. Open the cover assembly.
    - (1) Press in and hold the feed cover latches.
    - (2) While holding the latches, lift up on the cover assembly.
  - e. Remove any ammunition present.
  - f. Raise the feed tray.
  - g. Inspect the chamber to ensure that no ammunition is present.
  - h. Lower the feed tray.
  - i. Place the safety to the "F" position.
  - j. Pull and hold the cocking handle to the rear.
  - k. While holding the cocking handle to the rear, depress the trigger and ease the bolt forward to the closed and locked position.
2. Load ammunition.

**Note:** Position the open side of the links in the down position.

- a. Place the link belt on the feed tray with the first round against the cartridge stop and the tip of the round pointing towards the barrel.
- b. Close the cover assembly ensuring that the latches lock into place.

#### CAUTION

Make sure the round does not move away from the cartridge stop during the closing and latching of the cover.

**Evaluation Preparation:** *Setup:* Use dummy ammunition to test this task. At the test position, provide an M240B and a belt of linked dummy 7.62-mm ammunition. For standardization, always place the bolt and cocking handle forward and the safety on "S." Ensure that the ammunition is clean and linked properly.

*Brief Soldier:* Tell the Soldier to load the M240B machine gun.

Performance Measures	GO	NO GO
1. Cleared the weapon.	___	___
2. Loaded the ammunition.	___	___

**Evaluation Guidance:** Refer to chapter 1, paragraph 1-9e, (1) and (2).

**References**

**Required:**

**Related:** FM 3-22.68 and TM 9-1005-313-10

---

## 071-025-0004

### Unload an M240B Machine Gun

**Conditions:** Given an M240B loaded with linked 7.62-mm ammunition.

**Standards:** Remove all ammunition and links from the weapon. Clear the weapon and ensure that the chamber is empty and the safety is on "F" (fire).

#### Performance Steps

1. Remove the ammunition from the M240B.
  - a. With palm up, pull the cocking handle to the rear, ensuring that the bolt locks to the rear.
  - b. Return the cocking handle to its forward position.
  - c. Place the safety lever on "S" (safe).
  - d. Raise the cover and remove the ammunition belt.
  - e. Remove any ammunition, links, or brass from the chamber area.
2. Clear the M240B.
  - a. Confirm that no ammunition remains in the chamber.
  - b. Close the cover.
  - c. Place the safety on "F" (fire).
  - d. With palm up, pull the cocking handle to the rear and hold it.

**CAUTION**

The bolt must be eased forward to prevent damage to the feed tray assembly and operating rod assembly.

- e. Pull the trigger, allowing the bolt to ease forward.
- f. Place the safety on "F" (fire).

---

**Evaluation Preparation:** *Setup:* At the test site, provide the Soldier with all the equipment listed in the task conditions statement. Use only dummy ammunition for training purposes.

*Brief Soldier:* Tell the Soldier to unload the M240B.

Performance Measures	GO	NO GO
1. Removed ammunition from the M240B.	_____	_____
2. Cleared the M240B.	_____	_____

**Evaluation Guidance:** Refer to chapter 1, paragraph 1-9e, (1) and (2).

### References

### Required:

**Related:** FM 3-22.68 and TM 9-1005-313-10

## 071-025-0005

### Correct Malfunctions of an M240B Machine Gun

**Conditions:** Given a loaded M240B machine gun and linked 7.62-mm ammunition. The M240B machine gun has been firing and one of the following situations has developed:

1. The weapon has failed to fire.
2. The weapon has uncontrolled fire (continues to fire after the trigger is released).
3. The weapon is firing sluggishly.

**Standards:** Eliminate interruptions in the cycle of functioning caused by faulty action of the M240B or faulty ammunition without damaging the M240B machine gun. Report deficiencies not correctable at operator level to the supervisor.

#### Performance Steps

1. Take immediate action to correct a failure to fire.
  - a. Grasp the cocking handle (palm up) and pull it to the rear.
  - b. Look at the ejection port to see if a cartridge case, belt link, or round is ejected.
    - (1) If nothing is ejected—
      - (a) Lock the bolt to the rear.
      - (b) Return the cocking handle forward.
      - (c) Place the safety to "S" and proceed to step 2 or 3 to take remedial action.
    - (2) If a cartridge or round is ejected—
      - (a) Return the cocking handle to the forward position.
      - (b) Aim and fire the weapon at the target.
      - (c) If the weapon does not fire, place the weapon on "S" and proceed to step 2 or 3 to take remedial action.
2. Take remedial action on a cold weapon (one that has fired less than 200 rounds in two minutes).

## Performance Steps

- a. If immediate action fails to restore the weapon to an operational condition, perform remedial action.
  - b. Ensure that the cocking handle is forward and the weapon is on safe.
  - c. Keep the weapon oriented on the target area. Ensure that your face is not directly over the feed cover.
  - d. Raise the feed cover.
  - e. Remove the belt of ammunition.
  - f. Inspect for rounds in the chamber.
    - (1) If there are no rounds in the chamber—
      - (a) Reload and attempt to fire at the target. If the weapon fires, the stoppage has been corrected.
      - (b) If the weapon fails to fire, take immediate action (step 1). If the weapon still fails to fire continue to next step.
      - (c) Clear the weapon.
      - (d) Disassemble and inspect the weapon.
      - (e) Clean, lubricate, and replace damaged or missing parts, as required.
    - (2) If a cartridge is in the chamber—
      - (a) Close the cover.
      - (b) Attempt to fire. If the weapon fires, the stoppage has been corrected. Reload and continue the mission.
      - (c) If the weapon does not fire, continue to next step.
      - (d) Lock the bolt to the rear.
      - (e) Remove the barrel and remove the cartridge from the chamber using a cleaning rod. Insert the cleaning rod through the muzzle end of the barrel and gently tap out the cartridge.
      - (f) Clear the weapon.
      - (g) Disassemble and inspect the weapon and ammunition.
      - (h) Clean, lubricate, and replace damaged or missing parts, as required.
      - (i) Load and attempt to fire.
      - (j) If the weapon fails to fire, turn in for maintenance.
3. Take remedial action on a hot weapon (one that has fired more than 200 rounds in two minutes).
-

## Performance Steps

- a. If nothing was ejected when you applied immediate action—
  - (1) Ensure that the cocking handle is forward and the weapon is on safe.
  - (2) Keep the weapon oriented on the target area WITH THE COVER CLOSED.

### WARNING

During training, wait 15 minutes before applying remedial action. During combat, wait 5 seconds before applying remedial action because of the possibility of a "hangfire" or "cook off." You can also change barrels, reload, and continue firing.

- (3) Wait 15 minutes.
    - (4) Clear the weapon and perform remedial action for a cold gun (step 2).
  - b. If a cartridge or round is ejected—
    - (1) Return the cocking handle to the forward position.
    - (2) Aim and fire the weapon at the target.
    - (3) If the weapon does not fire—
      - (a) Clear the weapon.
      - (b) Disassemble and inspect the weapon.
      - (c) Clean, lubricate, and replace damaged or missing parts, as required.
      - (d) Load and attempt to fire.
      - (e) If the weapon fails to fire, turn it in for maintenance.
4. Take immediate action to secure a runaway weapon.
- a. Take one of the following actions if the weapon continues to fire after releasing the trigger:
    - (1) Hold the weapon on the target until it stops firing.
    - (2) Break the ammunition belt by twisting it in either direction.
    - (3) Allow the weapon to fire the remaining ammunition at the target.
  - b. Clear the weapon.
  - c. Disassemble the weapon and check the weapon for the following deficiencies:
    - (1) Worn or broken sear or sear notch.
    - (2) Sear installed backwards.
    - (3) Bolt and operating-rod group improperly joined.
    - (4) Carbon buildup in the gas port.
  - d. Clean, lubricate, and replace damaged or missing parts, as required.
  - e. Turn the weapon in to maintenance before firing again.

### Performance Steps

5. Correct sluggish operation of the M240B machine gun.
  - a. Clear the weapon.
  - b. Disassemble and inspect the weapon.
  - c. Clean, lubricate, and replace damaged or missing parts, as required.

**Evaluation Preparation:** *Setup:* At a test site or live-fire range, provide an M240B machine gun on a tripod with traversing and elevating (T&E) mechanism or a bipod, a belt of 15 to 20 blank or dummy rounds, and an assistant gunner. Set up the weapon so that it is loaded and the safety is on safe. Insert an expended round into the belt to cause a stoppage.

*Brief Soldier:* Tell the Soldier to assume a firing position behind the M240B machine gun and to apply any required immediate action. Tell the Soldier that the test does not require him/her to perform remedial action. Ask the Soldier to describe actions to perform for remedial action on cold or hot weapons, sluggish operation, and a runaway weapon.

Performance Measures	GO	NO GO
1. Took immediate action for failure to fire within 10 seconds.	___	___
2. Took remedial action on a cold weapon.	___	___
3. Took remedial action on a hot weapon.	___	___
4. Performed immediate action to secure a runaway weapon.	___	___

**Evaluation Guidance:** Refer to chapter 1, paragraph 1-9e, (1) and (2).

### References

#### Required:

**Related:** FM 3-22.68 and TM 9-1005-313-10

## 071-025-0007

### Engage Targets with an M240B Machine Gun

**Conditions:** Given an M240B machine gun, linked 7.62-mm ammunition, targets in an assigned sector of fire, and a requirement to engage those targets.

**Standards:** Fire the M240B machine gun to engage targets in the assigned sector of fire, and use correct M240B machine gun target engagement techniques so that you hit each target.

### Performance Steps

1. Assume a suitable firing position. Based on the situation, assume the position that allows you to observe and engage targets yet minimizes your exposure to enemy fire.

## Performance Steps

**a.** Tripod firing. A number of firing positions can be used based on the situation (prone, sitting, or kneeling; or standing if firing from a prepared position).

**b.** Bipod firing. Prone-supported position and bipod-supported fighting position are the best positions for delivering effective fire on targets. Assume these positions when possible.

(1) Shoulder firing position. Use this position to engage specific targets during movement when you can assume no other position or the situation dictates its use, such as the final stages of an assault.

(2) Underarm firing position. Use this position when closing with the enemy, when a heavy volume of fire in the target area is required, and when rapid movement is necessary.

(3) Hip firing position. Use this position when a heavy volume of fire in the target area is required and rapid movement is not necessary.

2. Identify targets in your designated sector of fire.

3. Align the sights on the target.

**a.** Obtain sight alignment by centering the front sight blade in the aperture of the rear sight with the top of the front sight blade even with the top of the rear sight slide.

**b.** Obtain a sight picture by centering the target over the front sight blade so that it appears to rest on top of the front sight blade and on top of the rear sight slide.

4. Load and engage targets using the correct M240B firing techniques.

**a.** Use the correct trigger manipulation.

(1) Pull straight to the rear and release.

(2) Fire the weapon at the rate of fire appropriate for the target (sustained, rapid, or cyclic).

**b.** Use the correct fire engagement technique based on target types.

(1) Deliver fixed fire against a point target when only one aiming point is necessary to cover the target with fire.

(2) Use traversing fire to distribute fire on wide targets by successive changes in direction.

(a) With the tripod-mounted gun, make changes in 2- to 6-mil increments on the traversing handwheel between bursts.

(b) With the bipod-mounted gun, make minor changes by shifting your shoulders to the right or left to select successive aiming points throughout the width of the target area. For major changes, move your elbows and align your body to remain directly behind the gun.

(3) Use searching fire to distribute fire on deep targets by successive changes in elevation.

## Performance Steps

(a) With the tripod-mounted gun, make changes in 2-mil increments on the elevating hand wheel between bursts.

(b) When using the bipod, move your elbows closer together to lower the muzzle, or farther apart to raise the muzzle.

(4) Use traversing and searching fire to distribute fire on wide and deep targets by successive changes in direction and elevation. Make adjustments in the same manner as described for traversing fire and searching fire.

(5) Use swinging traverse fire (tripod-mounted gun only) to deliver fire against targets too wide to cover with the traversing hand wheel or against fast moving targets. Loosen the traversing slide lock lever and make changes in direction by moving the muzzle left or right. Make changes in elevation by turning the elevating handwheel.

(6) Use free gun fire (tripod- or vehicle-mounted gun only) against targets requiring rapid major changes in direction and elevation. To deliver this type of fire, remove the traversing and elevation (T&E) mechanism from the receiver to allow the gun to be moved in any direction.

c. Use the correct fire application to engage specific types of targets (for single gun engagement).

(1) Point target. Engage point targets with fixed fire.

(2) Area target. Initially aim at the midpoint of the target area. Traverse and search to either flank, then back to the opposite flank.

(3) Linear target. Initially aim at the midpoint of the target. Traverse fire to one flank and then to the other to cover the entire target.

(4) Deep target. Initially aim at the midpoint of the target unless another portion of the target is more critical or presents a greater threat. Search down to one aiming point in front of the near end and back up to one aiming point beyond the far end.

(5) Linear target with depth. Initially aim at the midpoint of the target unless another portion of the target is more critical or presents a greater threat. Traverse and search to the flank closest to your position, and then back to the other to cover the entire target.

(6) Moving target. To hit a moving target, estimate the speed of the target and the lead required to fire and hit it. Fire, then track the target as it moves. Adjust the lead by observing tracers and the strike of the bullets.

d. Adjust fire to place effective fire on the target. Based on time, range, and amount of adjustment, use one of the following methods:

(1) Sight correction method. When the initial burst is not correctly placed, adjust elevation and windage as required. This method is time consuming.

(2) Adjusted aiming point method. Use the adjusted aiming point method to quickly adjust fires without making a sight adjustment. If the initial burst misses the target, rapidly select a new aiming point at the same distance from the target as the center of impact of the initial burst but in the opposite direction.

---

**Evaluation Preparation:** *Setup:* Evaluate this task on a live-fire range. Evaluate the Soldier's ability to use correct engagement techniques to engage specific types of targets. Provide the Soldier with equipment and materials required to fire the course.



*Brief Soldier:* Brief Soldier on range safety in accordance with installation regulations. Tell the Soldier to assume the bipod-supported prone position or bipod-supported fighting position. Tell the Soldier that you are evaluating both his/her ability to adjust fire and his/her ability to hit the target.

Performance Measures	GO	NO GO
1. Assumed a suitable firing position.	___	___
2. Identified targets in your designated sector of fire.	___	___
3. Aligned the sights on the target.	___	___
4. Loaded and engaged targets using the correct M240B firing techniques.	___	___

**Evaluation Guidance:** Refer to chapter 1, paragraph 1-9e, (1) and (2).

**References**

**Required:**

**Related:** FM 3-22.68 and TM 9-1005-313-10

## 071-025-0015

### Mount an M240B Machine Gun on an M122A1 Tripod

**Conditions:** Given an M240B machine gun, M122A1 tripod assembly (M122 tripod, traversing and elevating [T&E] mechanism, and flex mount assembly), and a requirement to mount an M240B machine gun on an M122A1 tripod assembly.

**Standards:** Install the M240B machine gun and components on the M122A1 tripod assembly so that the gun can be manipulated and fired to engage targets effectively.

#### Performance Steps

1. Check to ensure that the weapon is clear.
2. Set up the M122A1 tripod assembly.
  - a. Set up the tripod.
    - (1) Open the front and rear legs and lock them in position.
    - (2) Place the tripod in position with the front leg pointing in the direction that the muzzle of the gun will be pointing.
  - b. Install the T&E mechanism.
    - (1) Check to ensure that the T&E handwheel is centered.
    - (2) Place the T&E mechanism on the traverse bar of the tripod with the T&E mechanism's locking lever to the rear. Lock the T&E mechanism to the traverse bar.
  - c. Install the flexible mount on the tripod.
    - (1) Place the pintle of the flex mount into the sleeve bushing on the tripod.
    - (2) Release the pintle lock to secure the flex mount to the tripod.

### Performance Steps

(3) Align the holes in the flex mount T&E cradle bracket with holes in the T&E mechanism. Insert the spring pin (attached to the flex mount) through the cradle bracket and the T&E mechanism.

3. Install the M240B machine gun on the M122A1 tripod.
  - a. Position the weapon over the flex mount and tripod.
  - b. Tilt the muzzle down and insert the receiver bushings into the front cradle slot of the flex mount.
  - c. Pull the weapon to the rear to fully seat the receiver bushings in the cradle.
  - d. Lower the weapon onto the flex mount to align the mounting hole in the trigger housing with the mounting hole in the flex mount.
  - e. Insert the spring pin through the hole in the flex mount and mounting hole in the trigger housing.

**Evaluation Preparation:** *Setup:* Provide a test site and all the material and equipment indicated in the task conditions statement.

*Brief Soldier:* Tell the Soldier to mount the M240B machine gun on the M122A1 tripod.

Performance Measures	GO	NO GO
1. Checked to ensure that the weapon was clear.	___	___
2. Set up the tripod.	___	___
3. Installed the M240B machine gun on the M122A1 tripod.	___	___

**Evaluation Guidance:** Refer to chapter 1, paragraph 1-9e, (1) and (2).

### References

### Required:

**Related:** FM 3-22.68 and TM 9-1005-313-10

## 071-025-0016

### Dismount an M240B Machine Gun from an M122A1 Tripod

**Conditions:** Given an M240B mounted on M122A1 tripod assembly (M122 tripod, traversing and elevating [T&E] mechanism, and flex mount assembly), and a requirement to remove the gun and component items from the tripod.

**Standards:** Remove the M240B machine gun and component items from the M122A1 tripod without damage to the equipment.

### Performance Steps

1. Check to ensure that the weapon is clear.
2. Remove the gun from the flex mount.
  - a. Remove the spring pin from the flex mount and receiver assembly.

### Performance Steps

- b. Lift up on the rear of the weapon.
        - c. Push forward to remove the front receiver bushings from the front cradle slot of the flex mount.
  3. Remove the components.
    - a. Remove the flex mount from the tripod.
      - (1) Remove the spring pin from the cradle bracket and T&E mechanism.
      - (2) Lift up on the pintle lock and lift the flex mount from the tripod.
    - b. Remove the T&E mechanism. Unlock the T&E mechanism's locking lever and remove it from the tripod.
    - c. Unlock and collapse the tripod legs.

**Evaluation Preparation:** *Setup:* Provide a test site and all the material and equipment indicated in the task conditions statement.

*Brief Soldier:* Tell the Soldier to dismount the M240B machine gun from the M122A1 tripod.

Performance Measures	GO	NO GO
1. Checked to ensure that the weapon was clear.	___	___
2. Removed the M240B from the flex mount.	___	___
3. Removed the components.	___	___

**Evaluation Guidance:** Refer to chapter 1, paragraph 1-9e, (1) and (2).

### References

### Required:

**Related:** FM 3-22.68 and TM 9-1005-313-10

## SUBJECT AREA 11: M249 MACHINE GUN

### 071-010-0006

#### Engage Targets with an M249 Machine Gun

**Conditions:** Given an M249 machine gun and linked 5.56-mm ammunition.

**Standards:** Apply correct M249 machine gun target engagement techniques and hit each target in your assigned sector of fire.

### Performance Steps

1. Assume a suitable firing position. Based on your situation, assume the position that will allow you to observe and engage targets, yet minimize your exposure to enemy fire.

## Performance Steps

a. Bipod-supported positions. When possible, assume the bipod-supported prone position (figure 071-010-0006-1) or the bipod-supported fighting position (figure 071-010-0006-2). They are the best positions for delivering effective fire on targets. Assume these positions when possible.

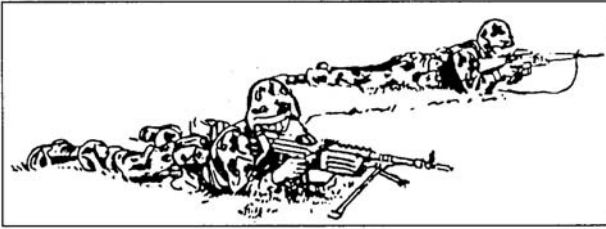

**Figure 071-010-0006-1. Bipod-supported prone position**



**Figure 071-010-0006-2. Bipod-supported fighting position**

b. Shoulder. Use the shoulder firing position (figure 071-010-0006-3) to engage targets at ranges less than 100 meters when no other position can be assumed or when the situation dictates its use (for example, in the final stages of the assault).

---



Figure 071-010-0006-3. Shoulder firing position

c. Underarm. Use the underarm firing position when moving in and around the objective during the assault (figure 071-010-0006-4).



Figure 071-010-0006-4. Underarm firing position

d. Hip. Use the hip firing position when closing with the enemy, when a heavy volume of fire in the target area is required, and when rapid movement is not necessary (figure 071-010-0006-5).

---



Figure 071-010-0006-5. Hip firing position

2. Fire the weapon using the correct sight picture (figure 071-010-0006-6).
  - a. Sight alignment. Center the front sight post in the peep sight (A, figure 071-010-0006-6).
  - b. Focus of the eye. Place the eye directly on line with the center of the rear sight. Focus on the tip of the front sight post. The natural ability of the eye to center objects in a circle and to seek the point of greatest light (center of the peep sight) aids in providing correct sight alignment.
  - c. Sight picture. Center the target over the front sight post (B, figure 071-010-0006-6). If firing on a 10-meter range target, use the sight picture in C, figure 071-010-0006-6.

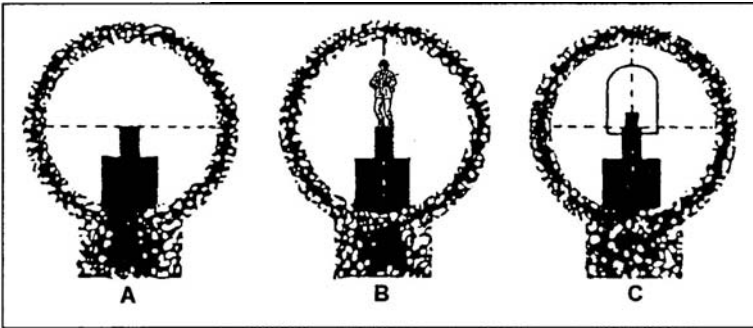
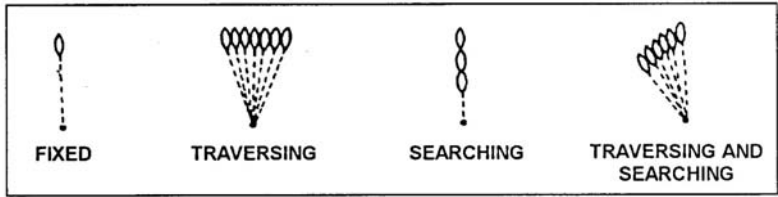

Figure 071-010-0006-6. Sight picture

3. Fire the weapon in three-round bursts at the rate of fire appropriate for the target size. Use correct trigger manipulation techniques (that is, pull the trigger straight to the rear and release it).

## Performance Steps

4. Apply the correct engagement technique based on target types (figure 071-010-0006-7).



**Figure 071-010-0006-7. Classes of fire with respect to the weapon**

- a.** Fixed fire. This type of fire is delivered against a point target when the depth and width of the beaten zone will cover the target. Only one aiming point is necessary to cover the target with fire.
  - b.** Traversing fire. This type of fire is distributed in width by successive changes in direction, which means moving the muzzle of the weapon to the left or right to distribute fire laterally. To make minor changes in direction, shift the shoulders to the right or left to select successive aiming points throughout the width of the target area. For major changes, move the elbows and align the body to remain directly behind the gun.
  - c.** Searching fire. This type of fire is distributed in depth by successive changes in elevation, which means moving the muzzle of the weapon up or down to distribute fire in depth. Select successive aiming points in depth throughout the target area. To make changes in elevation, move elbows closer together to lower the muzzle or farther apart to raise the muzzle.
  - d.** Traversing and searching fire. This type of fire is distributed in width and depth by successive changes in direction and elevation. Combining traversing fire and searching fire provides good coverage of the target. Adjustments are made in the same manner as described for traversing fire and searching fire, which means moving the muzzle of the weapon to the left or right to distribute fire laterally. To make minor changes in direction, shift the shoulders to the right or left to select successive aiming points throughout the width of the target area. For major changes, move the elbows and align the body to remain directly behind the gun.
5. Use observation of fire and adjustment of fire to place effective fire on the target.
    - a.** Observation of fire. Observe the burst of fire by noting the strike of the rounds in the target area, the tracers in flight, or, in the case of the 10-meter range, the holes made in the target.

## Performance Steps

b. Adjustment of fire. Use the adjusted aiming point method to quickly adjust fires without making a sight adjustment. If the initial burst misses the target, rapidly select a new aiming point the same distance from the center of impact of the initial burst but in the opposite direction. Fire a second burst (figure 071-010-0006-8).

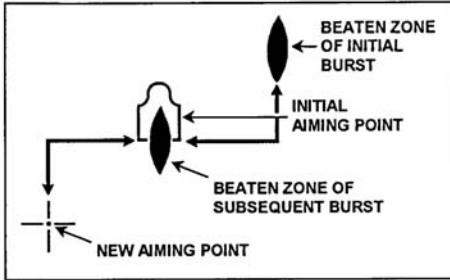

Figure 071-010-0006-8. Adjusted aiming point method

6. Use correct engagement technique to engage specific targets.
- a. Point target. Engage point targets with fixed fire (figure 071-010-0006-9).



Figure 071-010-0006-9. Engagement of point target

b. Area target. Initially, aim at the midpoint of the target area. Traverse and search to either flank, and then back to the opposite flank (figure 071-010-0006-10).



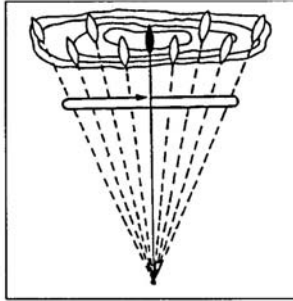

Figure 071-010-0006-10. Engagement of area target

c. Linear target. Initially, aim at the midpoint of the target. Traverse fire to one flank and then to the other to cover the entire target (figure 071-010-0006-11).



Figure 071-010-0006-11. Linear target

d. Deep target. Initially, aim at the midpoint of the target unless another portion of the target is more critical or presents a greater threat. Search down to one aiming point in front of the near end and back up to one aiming point beyond the far end (figure 071-010-0006-12).



Figure 071-010-0006-12. Deep target

**Performance Steps**

e. Linear target with depth. Initially, aim at the midpoint of the target unless another portion of the target is more critical or presents a greater threat. Traverse and search to the flank closest to your position and then back to the other flank to cover the entire target (figure 071-010-0006-13).

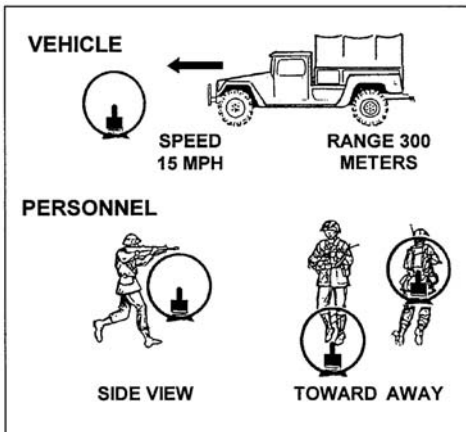

**Figure 071-010-0006-13. Linear targets with depth**

f. Moving target. To hit a moving target, estimate the speed of the target and the lead required to fire and hit it. Fire, then track the target as it moves. Adjust the lead by observing tracers and the strike of the bullets (figure 071-010-0006-14 and figure 071-010-0006-15).

SPEED IN MILES PER HOUR	RANGE OF TARGET		
	300 M	500 M	900 M
15	1/2 target length	1 target length	2 target lengths

**Figure 071-010-0006-14. Vehicle lead table**



**Figure 071-010-0006-15. Moving target aiming points**

**Evaluation Preparation:** *Setup:* Evaluate this task on a live-fire range by having the Soldier fire table IV in FM 3-22.68. Evaluate the Soldier's ability to use correct engagement techniques to engage specific types of targets. Provide the Soldier with equipment and materials required to fire the course.

*Brief Soldier:* Brief the Soldier on range safety in accordance with installation regulations. Tell the Soldier to assume the bipod-supported prone position or bipod-supported fighting position. Tell the Soldier you are evaluating both his/her ability to adjust fire and his/her ability to hit the target.

Performance Measures	GO	NO GO
1. Assumed correct bipod-supported prone position or bipod-supported fighting position.	_____	_____
2. Field zeroed on a 300-meter target with no more than 12 rounds.	_____	_____
3. Engaged single E-type silhouettes (point targets) at various ranges.	_____	_____
4. Engaged double E-type silhouettes (automatic weapon positions) at various ranges.	_____	_____
5. Engaged linear E-type silhouettes (troops on line) at various ranges.	_____	_____

**Evaluation Guidance:** Refer to chapter 1, paragraph 1-9e, (1) and (2).

#### References

#### Required:

**Related:** FM 3-22.68

## 071-312-4025

### Maintain an M249 Machine Gun

**Conditions:** Given an M249 machine gun; linked 5.56-mm ammunition; cleaning kit with pipe cleaners, small-arms swabs, chamber and bore brushes, cleaning rod, wiping rags, scraper tool, and cleaner lubricant preservative (CLP).

**Standards:** Clean and lubricate the M249 machine gun; inspect parts; turn in unserviceable parts; assemble the gun; ensure it is operational; clean and inspect linked 5.56-mm ammunition for serviceability; and turn in unserviceable ammunition.

#### Performance Steps

*Note:* The M249 machine gun is available with old and new style barrels. Diagrams used here show the new style barrel.

1. Clear the M249 machine gun.
  - a. Move the safety to the fire position.
  - b. With your right hand, palm up, pull the cocking handle to the rear and lock the bolt to the rear.

## Performance Steps

- c. Hold the cocking handle to the rear and move the safety to the safe position. Push the cocking handle forward to the locked position. Place weapon on safe.
  - d. Push the cocking handle forward to its lock position (you should hear a click).
  - e. Raise the cover and feed mechanism assembly. To check for brass, links, or ammunition—
    - (1) Check the feed pawl assembly under the feed cover.
    - (2) Check the feed tray assembly.
    - (3) Lift the feed tray assembly and inspect the chamber.
    - (4) Check the space between the bolt assembly and chamber.
    - (5) Insert two fingers in the magazine well and feel for brass or ammunition.
  - f. Close the cover and feed mechanism assembly. Move the safety to the fire position.
  - g. Pull the cocking handle to the rear, press the trigger, and ease the bolt forward.
2. Disassemble the M249 machine gun.

### WARNING

Ensure that the bolt is in the forward position before removing the drive spring, return rod, and transfer mechanism assembly.

- a. Remove the drive spring, return rod, and transfer mechanism assembly.
    - (1) Raise the cover assembly. Pull the upper retaining pin at the rear of the receiver to the left. Let the butt pivot downward so the rear opening of the receiver is clear (figure 071-312-4025-1).
-

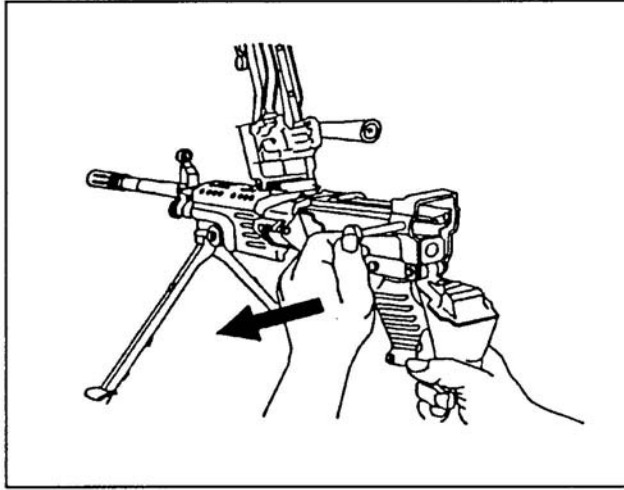

Figure 071-312-4025-1. Rear opening of the receiver

*Note:* The upper and lower retaining pins in the rear of the receiver are captured pins. Do not try to remove them completely during disassembly.

(2) Hold the weapon with one hand on the buttstock. At the same time, use the thumb of the other hand to push in and upward on the return rod and transfer mechanism assembly to release them from the positioning groove, then withdraw the return rod and transfer mechanism assembly and spring (figure 071-312-4025-2).

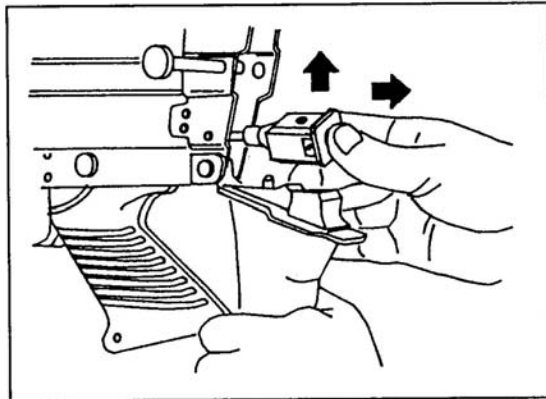

Figure 071-312-4025-2. Removal of the return rod and transfer mechanism assembly

(3) Separate the spring from the return rod and transfer mechanism assembly (figure 071-312-4025-3).

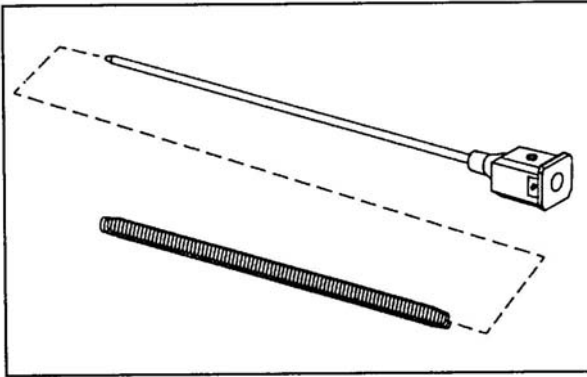

Figure 071-312-4025-3. Removal of the spring

- b. Remove the operating rod, slide assembly, and bolt assembly.

(1) Pull the cocking handle to the rear to move the operating rod, slide assembly, and bolt assembly from the rear of the receiver (figure 071-312-4025-4).

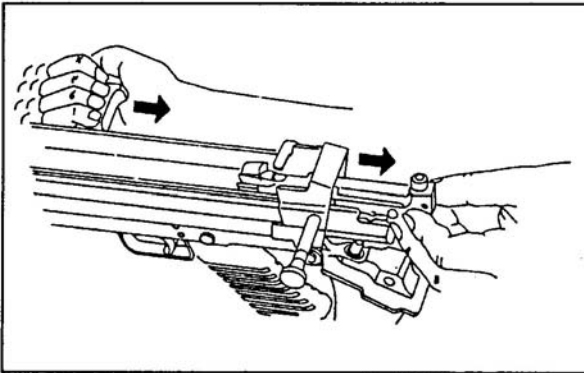

Figure 071-312-4025-4. Removal of the operating rod, slide assembly, and bolt assembly

(2) Rotate the bolt clockwise to disengage the lug. Remove the bolt from the slide assembly. Separate the piston from the slide assembly by pressing the rearmost retaining pin to the left and lifting the piston off the slide assembly (figure 071-312-4025-5).

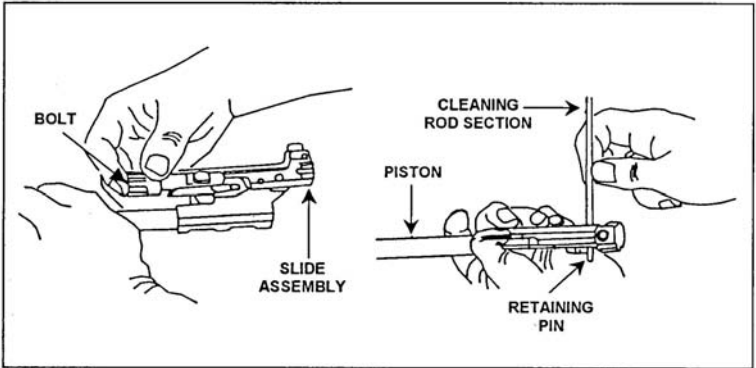

Figure 071-312-4025-5. Removal of the bolt and piston

- c. Remove the heat shield. Hold the weapon with one hand. With the other hand, grasp the heat shield just forward of the barrel handle, and lift it off of the barrel (figure 071-312-4025-6).

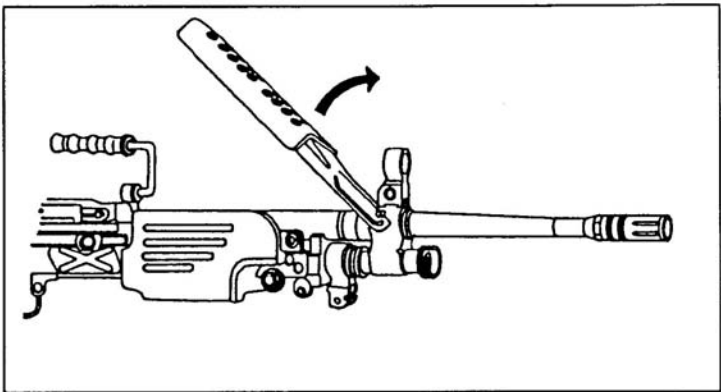

Figure 071-312-4025-6. Removal of the heat shield

- d. Remove the barrel (figure 071-312-4025-7).
- (1) Ensure that the folding handle on the new style barrel is in the carrying (up) position.
  - (2) Depress the barrel-locking lever with your left hand. Grasp and lift the carrying handle with your right hand. Push the barrel forward.

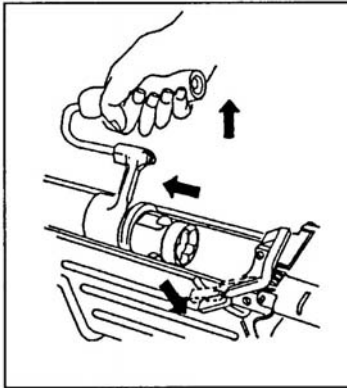

Figure 071-312-4025-7. Removal of the barrel

- e. Remove the handguard (figure 071-312-4025-8)
  - (1) Push the handguard retaining pin to the left using a section of the cleaning rod.
  - (2) Pull downward and remove the handguard.

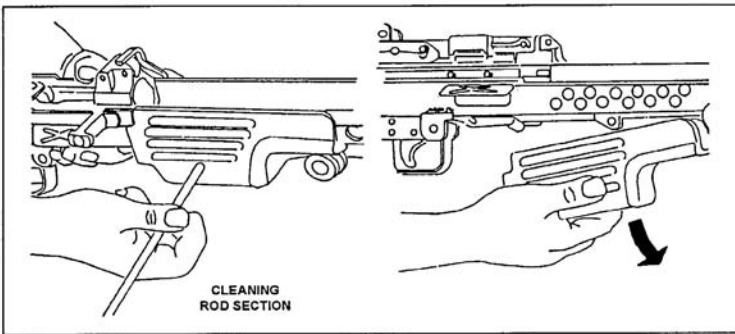

Figure 071-312-4025-8. Removal of the handguard

- f. Remove the gas regulator.
  - (1) Position the gas collar so you can insert the scraper assembly into the notch in the front left of the gas block.
  - (2) Insert the tip of the scraper assembly in the notch; hold the scraper firmly in position (figure 071-312-4025-9).



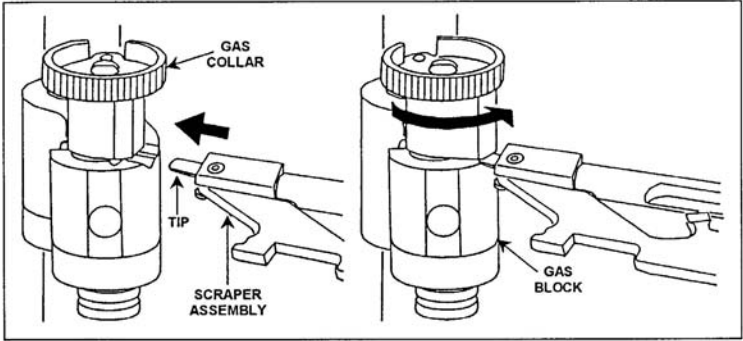

Figure 071-312-4025-9. Insertion of the scraper assembly

(3) Turn the collar counterclockwise and remove it (figure 071-312-4025-10).

(4) Remove the gas regulator from the gas block (figure 071-312-4025-10).

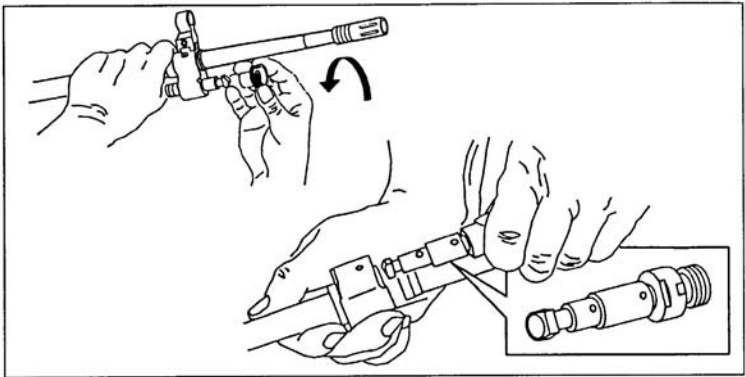

Figure 071-312-4025-10. Removal of the gas regulator from the gas block

g. Remove the buttstock and buffer assembly.

*Note:* The upper and lower retaining pins in the rear of the receiver are captured pins. Do not try to remove them completely during disassembly.

(1) Using a section of the cleaning rod, push the lowermost retaining pin to the left.

(2) While supporting the trigger mechanism with one hand, use the other to pull the buttstock and buffer assembly rearward and remove it (figure 071-312-4025-11).

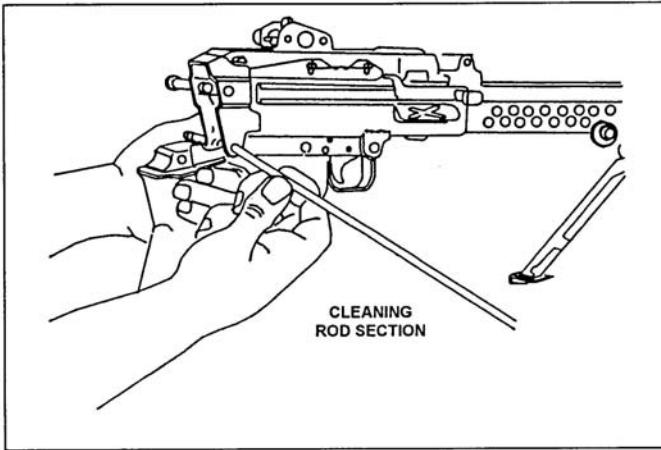

Figure 071-312-4025-11. Removal of the buttstock and buffer assembly

- h. Remove the trigger mechanism by pulling rearward and down (figure 071-312-4025-12).

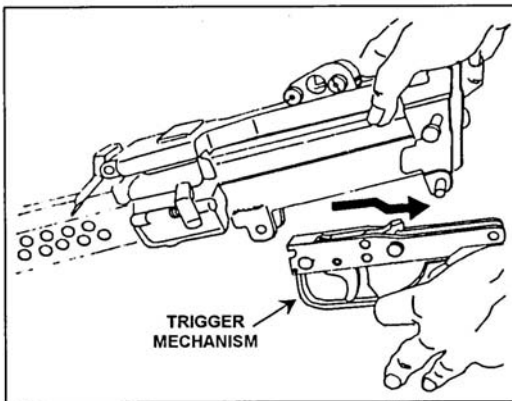

Figure 071-312-4025-12. Removal of the trigger mechanism

- i. Remove the gas cylinder.
  - (1) Turn the gas cylinder to the left or right to release the locking spring.
  - (2) Pull the gas cylinder forward to remove it (figure 071-312-4025-13).

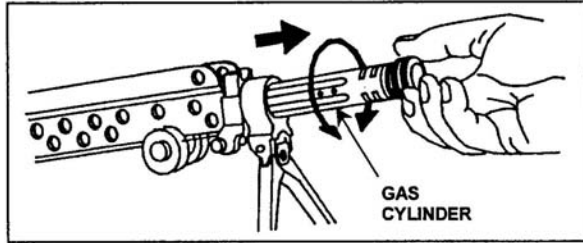

Figure 071-312-4025-13. Removal of the gas cylinder

- j. Remove the bipod. The bipod should slip off the receiver easily. If it does not, turn the bipod left or right to loosen any dirt or corrosion (figure 071-312-4025-14).

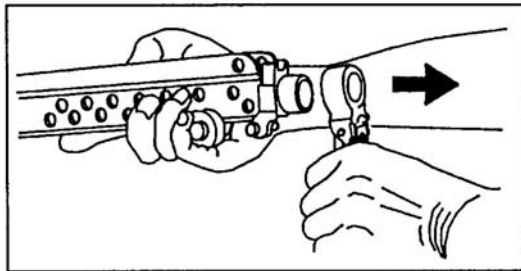

Figure 071-312-4025-14. Removal of the bipod

- 3. Clean the M249.

**WARNING**

Do not use gasoline, kerosene, hydraulic oil, benzene, benzol, high-pressure water, steam, or compressed air for cleaning.

*Note:* Do not use abrasives to clean the bore, piston, gas cylinder, or gas regulator.

- a. Clean the bore and chamber using a bore brush, a chamber brush, CLP, and fresh swabs..

- b. Clean the gas regulator using the scraper. Do not use CLP on the collar, gas block, or body.

- (1) Clean the gas vent hole (figure 071-312-4025-15).

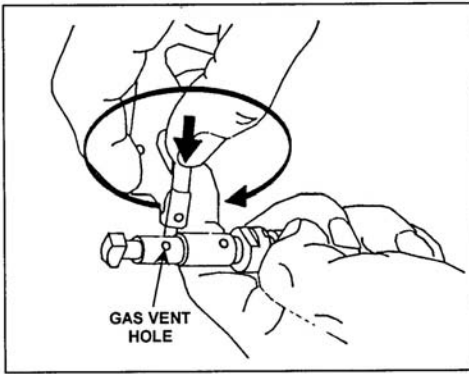

Figure 071-312-4025-15. Cleaning of the gas vent hole

(2) Clean the central hole of the gas regulator with the appropriate part of the scraper by turning the scraper clockwise and pushing it inward toward the bottom of the housing (figure 071-312-4025-16).

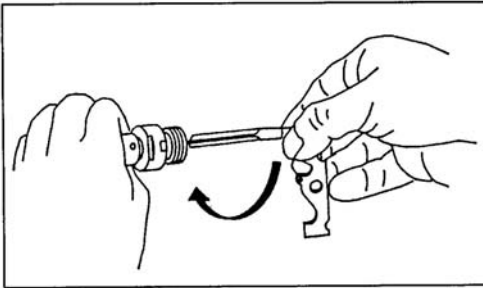

Figure 071-312-4025-16. Cleaning of the central hole

(3) Clean the two grooves of the regulator body using the protruding tips of the scraper (figure 071-312-4025-17).

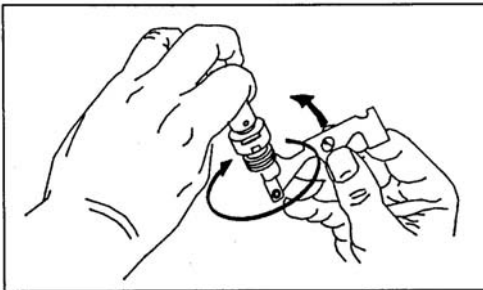

Figure 071-312-4025-17. Cleaning of the grooves of the regulator body

c. Clean the gas cylinder and piston using the scraper. Do not use CLP on the gas cylinder or on the piston.

## Performance Steps

(1) Clean the front interior of the gas cylinder (repositioned in receiver with bipod in place) by inserting and turning the flat side of the scraper in a full 360-degree circular motion (figure 071-312-4025-18).

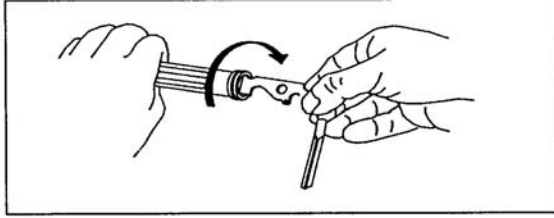

Figure 071-312-4025-18. Cleaning of the gas cylinder's internal grooves

(2) Clean the internal grooves on the front side of the gas cylinder as previously described (using the protruding tips of the scraper), but insert the scraper farther into the gas cylinder (figure 071-312-4025-19).

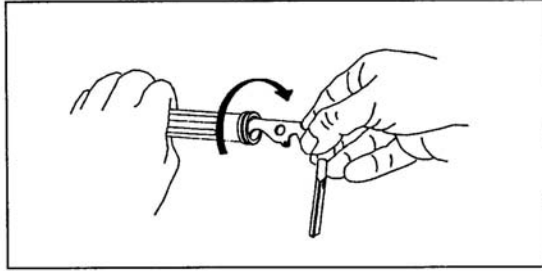

Figure 071-312-4025-19. Cleaning of the gas cylinder's internal grooves

(3) Clean the three grooves of the piston using a full, 360-degree circular motion (figure 071-312-4025-20).

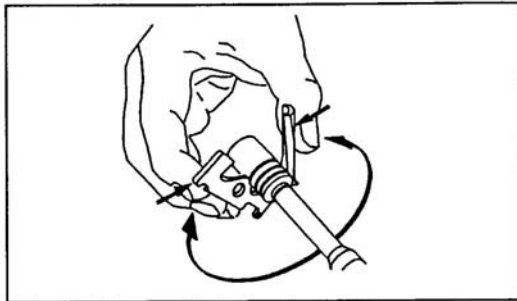
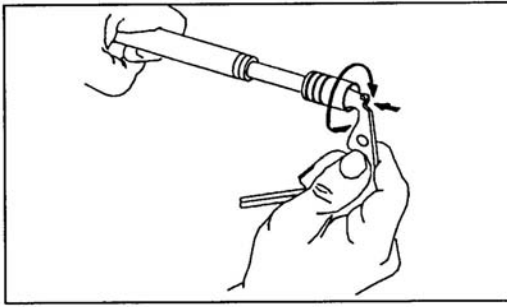

Figure 071-312-4025-20. Cleaning of the grooves of the piston

(4) Clean the hole in the front of the piston by inserting and turning the flat side of the scraper in a full 360-degree circular motion (figure 071-312-4025-21).



**Figure 071-312-4025-21. Cleaning of the hole in the piston**

- d. Remove carbon and dirt from all other parts of the weapon using CLP and a wiping rag.
  - e. Clean ammunition boxes with a brush and clean, dry wiping rag.
  - f. Clean ammunition with a clean, dry wiping rag.
4. Inspect the M249 machine gun.
- a. Inspect the bore and chamber for chips and pitting.
  - b. Check the front sight for looseness.
  - c. Inspect the flash suppressor (old style barrel) or compensator (new style barrel), the barrel extension, and the barrel release for cracks, dents, burrs, or other damage.
  - d. Check the cover assembly for smooth operation, spring tension, bent parts, and excessive wear.
  - e. Check the cocking assembly for free movement and for bent or cracked parts.
  - f. Check the rails for excessive wear, burrs, and chips.
  - g. Check the barrel-locking latch and the springs for tension.
  - h. Check for broken pistol grip and chipped or cracked trigger housing holding lug.
  - i. Check the tripping lever and the seat for burrs, cracks, chips, or wear.
  - j. Check the cocking action by pushing back on the tripping lever; the sear should rise. Pull the trigger; the sear should lower.
  - k. Check the safety function. Push the safety to the right so that the red band does not show. Pull the trigger; the sear will not lower. Push the safety to the left so that the red band shows. Pull the trigger again; the sear will lower.

## Performance Steps

- l.** Check the slide assembly, bolt assembly, piston assembly, and return rod and transfer mechanism assembly for burrs, cracks, and broken pins. Push down on the roller of the slide assembly to ensure it retracts. Check the driving spring for broken strands.
  - m.** Check the bipod legs for correct operation.
  - n.** Check the rear sight assembly for serviceability.
  - o.** Check the ammunition box for damage. Make sure the box latch will engage the receiver dovetail.
  - p.** Inspect ammunition.
    - (1)** Check for damaged, corroded, or loose bullets.
    - (2)** Check for damaged links.
    - (3)** Report to your squad leader or noncommissioned officer in charge (NCOIC) any deficiencies you cannot correct.
- 5.** Lubricate the M249.

*Note:* Use only CLP on the M249.

- a.** Lubricate exposed metal parts and all moving parts with a light coat of CLP.
    - b.** Do not lubricate the gas regulator hole in the barrel or the gas regulator itself.
  - 6.** Assemble the M249.
    - a.** Replace the bipod and gas cylinder.
      - (1)** Place the bipod on the receiver.
      - (2)** Push the gas cylinder through the bipod yoke into the receiver.
      - (3)** Push the cylinder to the rear. Counter the pressure of the locking spring and guide the end of the cylinder into the receiver, with your other hand applying downward pressure. When you have fully inserted the gas cylinder, rotate it until the spring clicks into place in the recess at the rear of the cylinder (figure 071-312-4025-22).
-

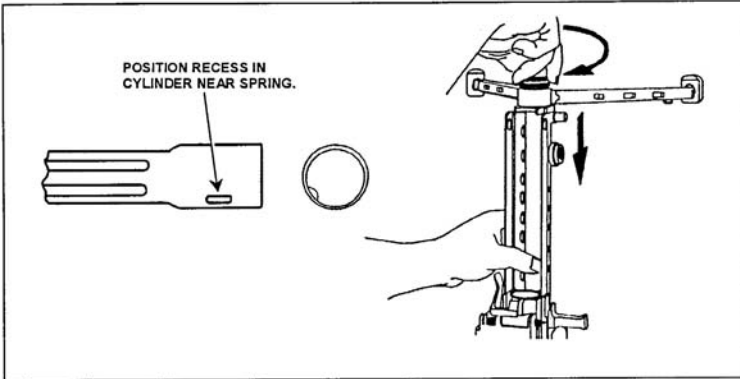

Figure 071-312-4025-22. Replacement of the bipod and gas cylinder

**b.** Replace the handguard.

- (1) Stow the cleaning equipment in the handguard.
- (2) Place the handguard onto the receiver and slide it backward until it stops.
- (3) Using a cleaning rod section, push the handguard retaining pin to the right. This locks the handguard into position (figure 071-312-4025-23).

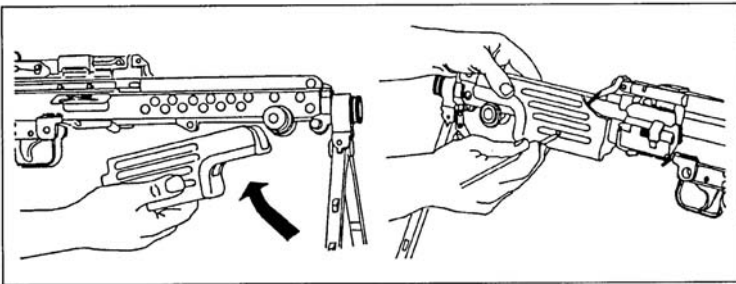

Figure 071-312-4025-23. Replacement of the handguard

- (4) Pull downward on the handguard to ensure that it locks into position.

**c.** Replace the gas regulator.

- (1) Insert the gas regulator into the lower end of the hole in the gas block. Align the notch on the gas regulator body with the notch in the gas block (figure 071-312-4025-24).



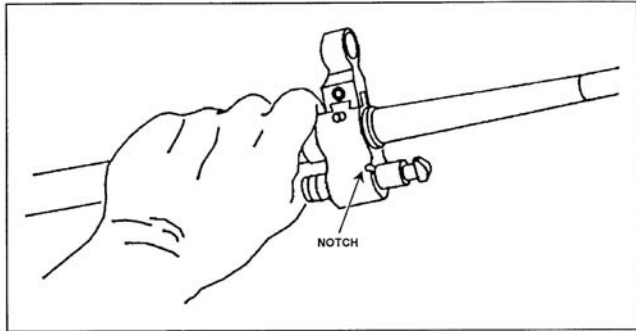

**Figure 071-312-4025-24. Replacement of the gas regulator**

(2) With the gas regulator installed and supported on a firm surface, place the gas collar on the protruding end of the gas regulator. Rotate the gas collar until it slips into place. To lock the gas regulator in place, press it in and rotate it (figure 071-312-4025-25).

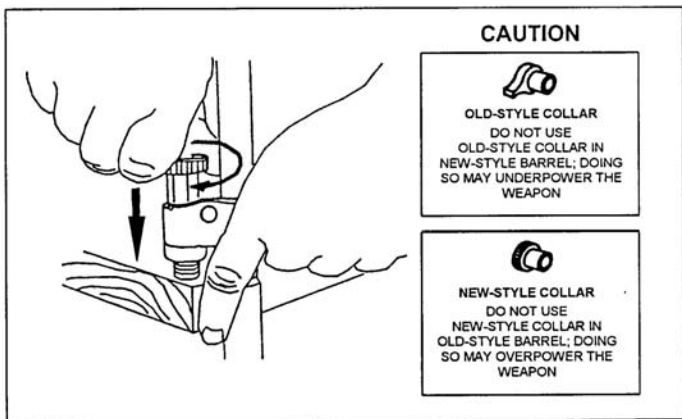

**Figure 071-312-4025-25. Replacement of the gas collar**

d. Replace the barrel.

(1) Depress the barrel-locking lever with your left hand (figure 071-312-4025-26).

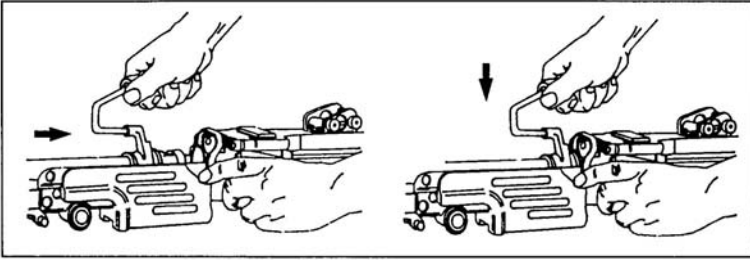

**Figure 071-312-4025-26. Replacement of the barrel**

(2) Hold the carrying handle with your right hand; pull the barrel rearward into the receiver. Push the carrying handle downward and release the barrel-locking lever. Check to ensure the barrel locks into position.

- e. Replace the trigger mechanism (figure 071-312-4025-27).

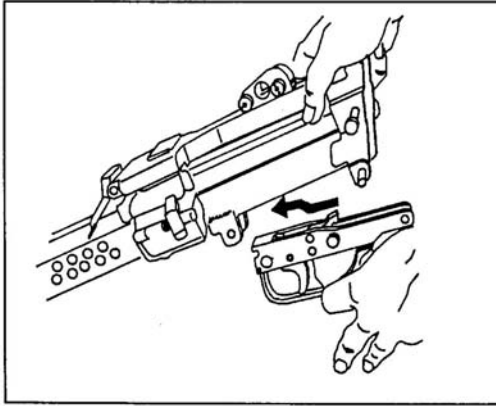
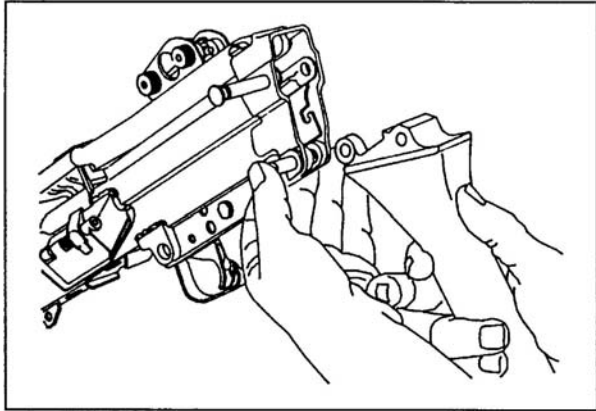

**Figure 071-312-4025-27. Replacement of trigger mechanism**

(1) Pull the retaining pin to the left side of the receiver.

(2) Align the trigger mechanism with the slot on the bottom of the receiver. To hold the trigger mechanism in place, push the lower retaining pin into the right side hole on the rear of the trigger mechanism assembly.

- f. Replace the buttstock and shoulder assembly (figure 071-312-4025-28). Support the trigger mechanism with your left hand. Align the lower hole in the buttstock and buffer assembly with the rear hole in the trigger mechanism. Push the lower retaining pin to the right.



**Figure 071-312-4025-28. Replacement of the buttstock and shoulder assembly**

**g.** Replace the operating rod, slide assembly, and bolt assembly.

**(1)** Secure the slide assembly to the piston by pushing the retaining pin from the left to the right. Place the firing pin spring on the firing pin (figure 071-312-4025-29).

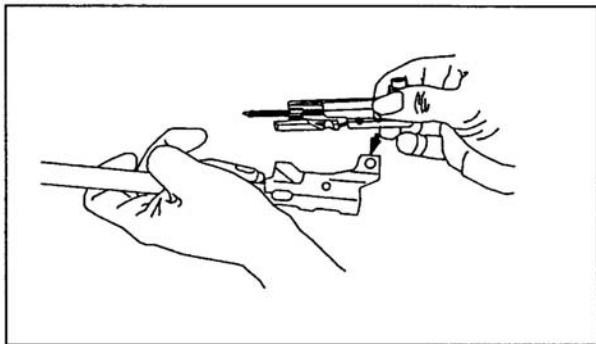

**Figure 071-312-4025-29. Attachment of the slide assembly to the piston**

**(2)** Put the bolt assembly into the slide assembly. Press in to compress the firing pin spring. Rotate the bolt and hook its driving lug into the slide assembly (figure 071-312-4025-30).

---

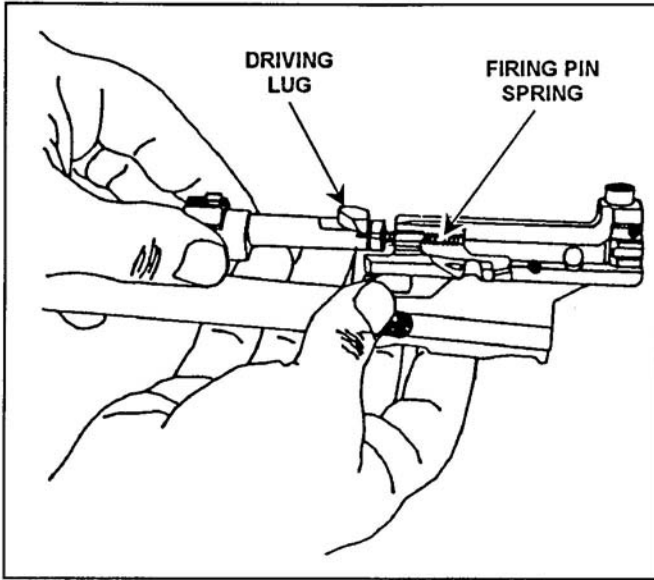

Figure 071-312-4025-30. Attachment of the bolt assembly to the slide assembly

(3) Put the assembled parts into the receiver with the feed cover open. Align and place the bolt lugs; slide the cutouts carefully onto the receiver rails. Press the trigger and, at the same time, push the parts all the way forward (figure 071-312-4025-31).

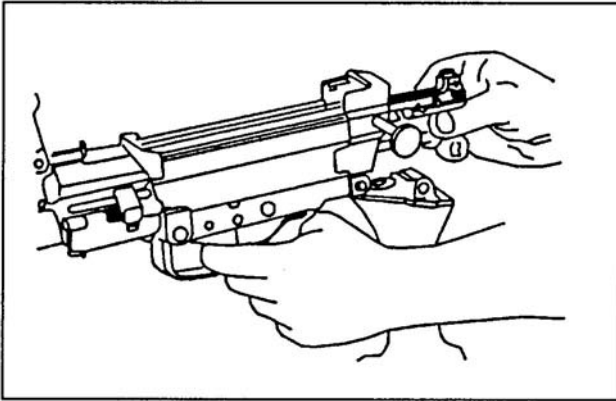

Figure 071-312-4025-31. Replacement of the operating rod, slide assembly, and bolt assembly

h. Replace the spring, return rod, and transfer mechanism assembly.

(1) Put the slide spring on the return rod and transfer mechanism assembly (figure 071-312-4025-32).

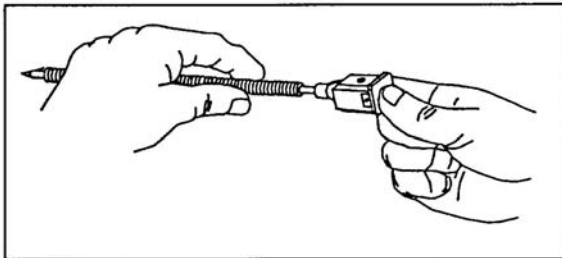

Figure 071-312-4025-32. Replacement of the spring

(2) Ensure that the headed end of the vertical pin in the transfer mechanism assembly points upward (on top of the transfer mechanism assembly) (figure 071-312-4025-33).

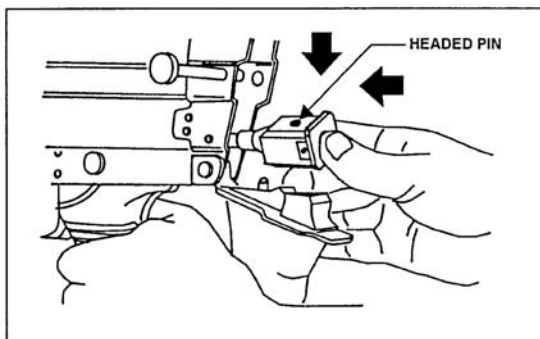

Figure 071-312-4025-33. Replacement of the return rod and transfer mechanism assembly

(3) Hold the pistol grip with one hand. With the other hand, push the return rod and transfer mechanism assembly into its housing in the piston. Press inward and downward on the rear of the assembly until its two lugs move into the receiver grooves.

i. Pivot the buttstock and buffer assembly upward into position. Push the retaining pin to the right, and close the cover assembly (figure 071-312-4025-34).

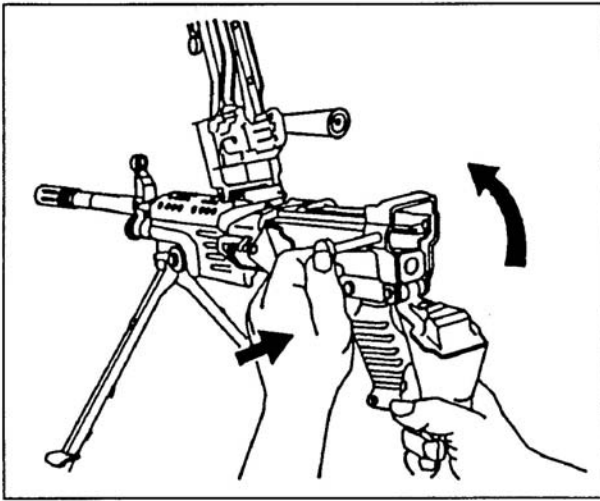

Figure 071-312-4025-34. Cleaning of the rear of the receiver

- j. Replace the heat shield assembly (figure 071-312-4025-35).

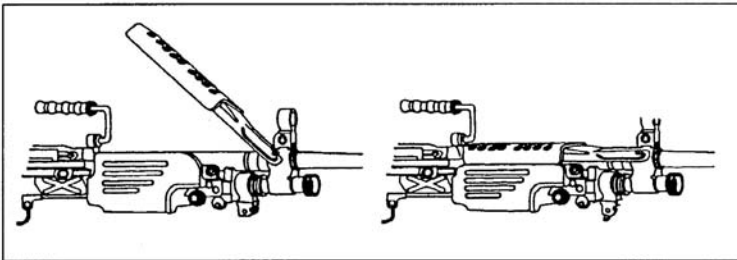

Figure 071-312-4025-35. Replacement of the heat shield assembly

- (1) Hook the metal extensions of the heat shield assembly under the front sight pins (new style barrel) with the spring clips down on top of the barrel

*Note:* Although old style barrels lack protruding front sight pins, you can still install heat shield assemblies on them.

- (2) Apply downward pressure and snap the heat shield onto the barrel. Be careful not to pinch yourself.

7. Perform a function check to ensure that you have assembled the weapon correctly.

**Evaluation Preparation:** *Setup:* At the test site, provide all the equipment and materials listed in the task conditions statement. Use only dummy ammunition for training purposes.

*Brief Soldier:* Tell the Soldier to perform maintenance on the M249, ammunition box, and linked 5.56-mm ammunition.

Performance Measures	GO	NO GO
1. Cleared the weapon.	___	___
2. Disassembled the weapon without damaging any parts.	___	___
3. Cleaned the weapon, ammunition box, and ammunition.	___	___
4. Identified any damage, worn, or malfunctioning part(s).	___	___
5. Identified any damaged ammunition.	___	___
6. Lubricated the weapon using the correct lubrication technique.	___	___
7. Assembled the weapon in correct sequence without damaging any parts.	___	___

**Evaluation Guidance:** Refer to chapter 1, paragraph 1-9e, (1) and (2).

### References

**Required:** TM 9-1005-201-10

**Related:** FM 3-22.68

## 071-312-4026

### Perform a Function Check on an M249 Machine Gun

**Conditions:** Given an M249 machine gun.

**Standards:** Conduct an operational check of the M249 machine gun and ensure that it is correctly assembled and functions properly.

#### Performance Steps

1. Grasp the cocking handle with the right hand, palm facing up, and pull the bolt back, locking it to the rear.
2. Push the cocking handle forward to the lock position.
3. Place the weapon on SAFE.
4. Pull the trigger. (The weapon should not fire.)
5. With the right hand, palm facing up, pull cocking handle to the rear and hold it.
6. Place the weapon on FIRE.
7. Maintain the grasp on the cocking handle, pull the trigger and allow the bolt to ease forward to prevent damage to the bolt.

**Note:** When using dummy rounds, skip step number 5 and do not allow the bolt to ease forward.

**Evaluation Preparation:** *Setup:* At the test site, provide the equipment listed in the task condition statement.

*Brief Soldier:* Tell the Soldier to perform a function check to determine if the M249 machine gun functions properly.

Performance Measures	GO	NO GO
1. Grasped the cocking handle with the right hand, palm facing up, and pulled the bolt back, locking it to the rear.	___	___
2. Pushed the cocking handle forward to the lock position.	___	___
3. Placed the weapon on SAFE (red band was hidden).	___	___
4. Pulled the trigger. (The weapon did not fire)	___	___
5. With the right hand, palm facing up, pulled the cocking handle to rear and held it.	___	___
6. Took the weapon off SAFE (red band showed).	___	___
7. Maintained grasp on the cocking handle, pulled the trigger, and allowed the bolt to ease forward to prevent damage to the bolt.	___	___
<i>Note:</i> When using dummy rounds, skipped step 5 and did not allow the bolt to ease forward.		

**Evaluation Guidance:** Refer to chapter 1, paragraph 1-9e, (1) and (2).

**References**

**Required:**

**Related:** FM 3-22.68 and TM 9-1005-201-10

## 071-312-4027

### Load an M249 Machine Gun

**Conditions:** Given an M249 machine gun, small arms ammunition box, and linked 5.56-mm ammunition.

**Standards:** Attach the ammunition box to the receiver correctly. Place linked 5.56-mm ammunition in the feed tray groove so that, when the cover is closed, a round remains in the tray groove and the ammunition feeds correctly.

#### Performance Steps

1. With your palm facing up, pull the cocking handle to the rear. This locks the bolt in the rear position.
2. Push the cocking handle forward until you hear it click into the locked position (figure 071-312-4027-1).



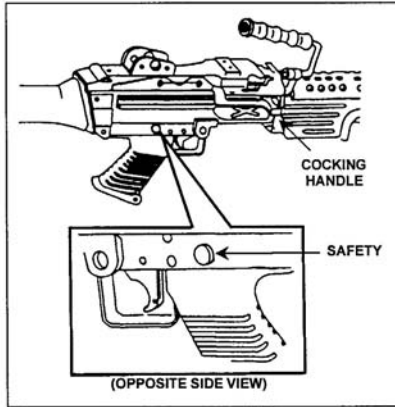

Figure 071-312-4027-1. M249 locking handle and safety

3. Push the safety from left to right for safe mode (the red band will not show) (figure 071-312-4027-1).
4. Open the cover, raise the feed tray assembly, and make sure the feed tray, receiver, and chamber area are clear (figure 071-312-4027-2).

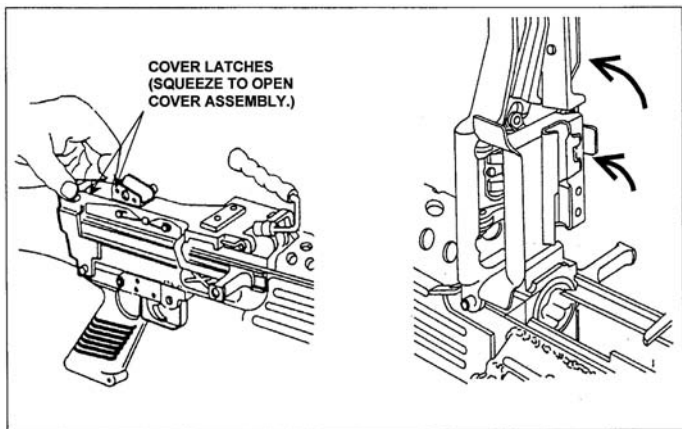

Figure 071-312-4027-2. Checking the feed tray, receiver, and chamber area

5. Attach the ammunition box with linked 5.56-mm ammunition to the underside of the receiver. To do so, align the box latch with the dovetail on the receiver (figure 071-312-4027-3). Pull outward on the ammunition box to make sure the aligning box latch engages.

## Performance Steps

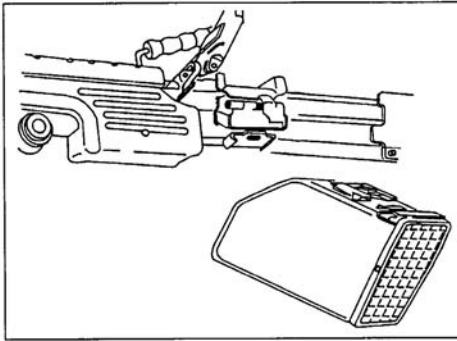

Figure 071-312-4027-3. Attachment of the ammunition box

6. Place the link belt in the feed tray with the first round against the cartridge stop, and hold the belt in place. Close the cover assembly (figure 071-312-4027-4).

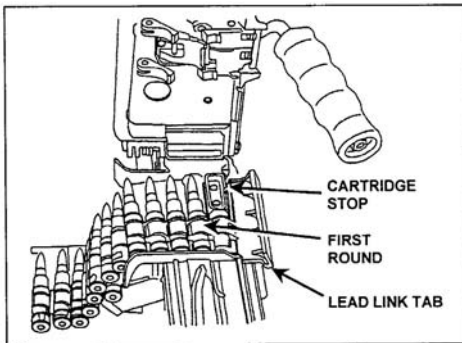

Figure 071-312-4027-4. Link belt in the feed tray

### WARNING

The weapon is now loaded.

**Evaluation Preparation:** *Setup:* Use dummy ammunition to test this task. At the test position, provide an M249 and a belt of linked, dummy 5.56-mm ammunition. For standardization, always make sure to place the bolt and cocking handle forward and the safety on. Ensure that the ammunition is clean and linked properly. Have an assistant relink and wipe the ammunition clean before the next test.

*Brief Soldier:* Tell the Soldier to load the M249 machine gun.

Performance Measures	GO	NO GO
1. Locked the bolt in the rear position.	___	___
2. Pushed the cocking handle forward to the locked position.	___	___

Performance Measures	GO	NO GO
3. Pushed the safety to the safe position.	_____	_____
4. Checked to make sure the feed tray, receiver, and chamber were clear.	_____	_____
5. Attached the ammunition box with linked ammunition to the receiver.	_____	_____
6. Placed the link belt in the feed tray with the first round against the cartridge.	_____	_____
7. Closed the cover.	_____	_____

**Evaluation Guidance:** Refer to chapter 1, paragraph 1-9e, (1) and (2).

**References**

**Required:**

**Related:** FM 3-22.68 and TM 9-1005-201-10

## 071-312-4028

### Unload an M249 Machine Gun

**Conditions:** Given an M249 machine gun loaded with 5.56-mm ammunition (linked or in an M16 magazine).

**Standards:** Remove all ammunition, expended brass, links, and magazine from the weapon.

<b>Performance Steps</b>
--------------------------

1. Pull the cocking handle to the rear to lock the bolt in the rear position.
2. Place the safety on safe (the red band will not show) and return the cocking handle to its forward position.
3. Remove ammunition and links.
  - a. Belt-fed. Raise the cover and remove any ammunition or links from the feed tray.
  - b. Magazine-fed. Push down on the magazine release tab and pull the magazine out. Then, raise the cover.
4. Raise the feed tray and inspect the chamber to ensure that it contains no ammunition. However, if it does contain ammunition, remove the ammunition.
5. Close the cover.
6. Place the safety in the fire mode (the red band will show).
7. Pull the cocking handle to the rear, and pull the trigger while manually easing the bolt forward to the closed position.

**Evaluation Preparation:** *Setup:* At the test site, provide the Soldier with all the equipment given in the task condition statement. Evaluate this task using dummy 5.56-mm linked rounds or dummy 5.56-mm ammunition loaded in 30-round M16 magazines.

*Brief Soldier:* Tell the Soldier to unload the M249 in the correct manner.

Performance Measures	GO	NO GO
1. Pulled the cocking handle to the rear, locking the bolt in the rear position.	_____	_____
2. Placed the safety on safe mode (the red band did not show) and returned the cocking handle to its forward position.	_____	_____
3. Removed ammunition and links.	_____	_____
4. Raised the feed tray and inspected the chamber to ensure that it contained no ammunition. If it did contain ammunition, removed it.	_____	_____
5. Closed the cover.	_____	_____
6. Placed the safety in the fire mode (the red band showed).	_____	_____
7. Pulled the cocking handle to the rear, and pulled the trigger while manually easing the bolt forward to the closed position.	_____	_____

**Evaluation Guidance:** Refer to chapter 1, paragraph 1-9e, (1) and (2).

**References**

**Required:**

**Related:** FM 3-22.68

## 071-312-4029

### Correct Malfunctions of an M249 Machine Gun

**Conditions:** Given a loaded M249 machine gun that has been firing, 5.56-mm ammunition linked or loaded in an M16 magazine, and one of the following situations:

1. The weapon failed to fire.
2. The weapon continued to fire (runaway weapon, uncontrolled fire) after the trigger was released.
3. The weapon began firing sluggishly.

**Standards:**

1. If an M249 fails to fire, take immediate action within 10 seconds, and return the weapon to service without identifying the cause. If immediate action fails, perform remedial action on either a hot or cold M249, and identify the cause of the malfunction.

2. If an M249 continues to fire after the trigger is released, that is, if a runaway M249 begins firing uncontrolled fire, take immediate action, secure the weapon, and identify the cause of the malfunction.

3. If an M249 starts firing sluggishly, take corrective action.

### Performance Steps

1. Take immediate action to correct a failure to fire.
  - a. Grasp the cocking handle (palm up) and pull it to the rear.
  - b. Look at the ejection port to see if a cartridge case, belt link, or round ejects.
    - (1) If nothing ejects—
      - (a) Lock the bolt to the rear.
      - (b) Return the cocking handle forward.
      - (c) Proceed to step 2 or step 3 to take remedial action.
    - (2) If a cartridge, belt link, or round ejects—
      - (a) Return the cocking handle to the forward position.
      - (b) Aim and fire the weapon at the target.
      - (c) If the weapon does not fire, place it in the safe mode, and proceed to step 2 or step 3 to take remedial action.
2. Take remedial action on a cold weapon (one that has fired less than 200 rounds in two minutes).
  - a. Ensure the cocking handle is forward and the weapon is in the safe mode.
  - b. Keep the weapon oriented on the target area. Ensure your face is not directly over the feed cover, and open the feed cover.
  - c. If the weapon still does not fire, remove the ammunition belt or magazine.
    - (1) If no rounds are in the chamber—
      - (a) Reload and try to fire at the target. If the weapon fires, you have corrected the stoppage.
      - (b) If the weapon fails to fire, take immediate action (step 1). If the weapon still fails to fire, continue to the next step.
      - (c) Clear the weapon.
      - (d) Disassemble and inspect the weapon.
      - (e) Clean, lubricate, and replace damaged or missing parts, as needed.
    - (2) If a cartridge is in the chamber—
      - (a) Remove all ammunition from the feed tray and close the cover.
      - (b) Try to fire. If the weapon fires, you have corrected the stoppage. Reload and continue the mission.
      - (c) If the weapon fails to fire, continue to the next step.

## Performance Steps

- (d) Lock the bolt to the rear.
  - (e) With the cover closed, remove the round from the chamber using a cleaning rod.
  - (f) Clear the weapon.
  - (g) Disassemble and inspect the weapon.
  - (h) Clean, lubricate, and replace damaged or missing parts, as needed.
3. Take remedial action on a hot weapon (one that has fired more than 200 rounds in two minutes).
- a. Ensure the cocking handle is forward and the weapon is in the safe mode.
  - b. Keep the weapon oriented on the target area. Place the safety in the safe mode.

### WARNING

During training, wait 15 minutes before applying remedial action. During combat, wait five seconds before applying remedial action. This delay helps prevent a "hangfire" or "cook off."

- c. Raise the cover.
- d. Remove the ammunition belt or magazine.
- e. Raise the feed tray.
- f. Inspect the chamber.
  - (1) If no round is in the chamber--
    - (a) Reload and try to fire.
    - (b) If the gun fires, you have corrected the stoppage.
    - (c) If the weapon fails to fire, apply immediate action for a second time.
      - (d) If immediate action fails, continue to the next step.
      - (e) Disassemble and inspect the weapon.
      - (f) Clean, lubricate, and replace damaged or missing parts, as needed.
  - (2) If a round is in the chamber--
    - (a) Close the cover and try to fire.
    - (b) If the weapon fires, you have corrected the stoppage.
    - (c) If the weapon fails to fire, ensure the cocking handle is forward and the weapon is on safe.

## Performance Steps

- (d) Disassemble and inspect the weapon.
  - (e) Clean, lubricate, and replace damaged or missing parts, as needed.
4. Take immediate action to secure a runaway weapon.
- a. If after the trigger is released the weapon continues to fire, take one of the following actions:
    - (1) Hold the weapon on the target until the weapon stops firing.
    - (2) Break the ammunition belt by twisting it in either direction.
    - (3) Allow the weapon to fire the remaining ammunition at the target.
  - b. Clear the weapon.
  - c. Disassemble the weapon and check for the following deficiencies:
    - (1) Broken, worn, or burred sear.
    - (2) Worn sear notch on the piston assembly.
    - (3) Sear stuck in the trigger housing.
    - (4) Carbon buildup in the gas system.
  - d. Clean, lubricate, and replace damaged or missing parts, as required.
  - e. Turn the weapon in to maintenance before firing again.
5. Correct sluggish operation of the M249 machine gun.
- a. Clear the weapon.
  - b. Disassemble and inspect the weapon.
  - c. Clean, lubricate, and replace damaged or missing parts, as required.

**Evaluation Preparation:** *Setup:* At the test site or live-fire range, provide all the equipment listed in the task condition statement. Load the weapon and place it on safe. Insert a spent round in the belt to cause a stoppage. You can evaluate this task with dummy 5.56-mm ammunition either in links or in M16 magazines.

*Brief Soldier:* Tell the Soldier to assume a firing position behind the M249 and to apply the required immediate action. Ask the Soldier to describe remedial action on a cold and hot weapon, on a runaway weapon, and on a sluggishly operating weapon.

Performance Measures	GO	NO GO
1. Took immediate action to correct a failure to fire.	___	___
2. Took remedial action on a cold weapon.	___	___
3. Took remedial action on a hot weapon.	___	___
4. Took immediate action to secure a runaway weapon.	___	___
5. Corrected a sluggishly operating M249.	___	___

**Evaluation Guidance:** Refer to chapter 1, paragraph 1-9e, (1) and (2).

## References

### Required:

Related: FM 3-22.68

## SUBJECT AREA 12: MK19 MACHINE GUN

### 071-030-0001

#### Maintain an MK19 Machine Gun

**Conditions:** Given an MK19 machine gun, an M3 tripod, a traversing and elevating (T&E) mechanism, an M64 cradle mount; rifle bore cleaner (RBC), lubricant oil (LSA), or lubricating oil (LSAT or lubricating oil arctic weather [LAW]); grease (GMD); cleaning solvent (PD680); wiping rags or cloth (abrasive crocus); a cleaning rod assembly and a small arms cleaning brush; linked 40-mm ammunition, and one spent 40-mm cartridge case.

**Standards:** Clean and lubricate the MK19 and its components. Inspect all parts and turn in those needing maintenance. Reassemble the gun so that it is operational. Clean and inspect ammunition for serviceability. Turn in any unserviceable ammunition.

#### Performance Steps

1. Clear the MK19.
  - a. Place the safe/fire switch in the safe (S) position. Ensure that the bolt is forward.
  - b. Open the top cover and inspect the feed tray and extractors on the bolt face to ensure that no round is in the pickup position.
  - c. Unlock and pull the charger handle 2 to 3 inches to the rear; inspect the face of the bolt and the chamber for ammunition.
  - d. Return the bolt to the forward position and rotate the charger handle to the locked position.
2. Disassemble the MK19.
  - a. Remove the feed throat assembly (figure 071-030-0001-1). Squeeze the two sets of grip pins together and pull them straight out.
  - b. Remove the bolt and backplate assembly.



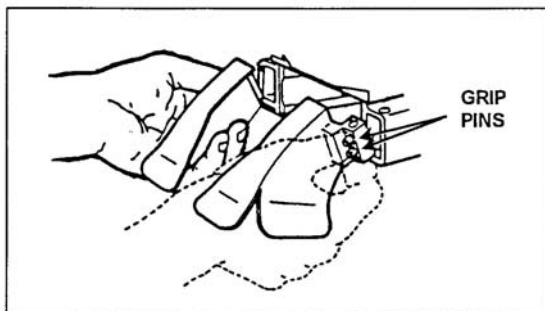

Figure 071-030-0001-1. Removal of feed throat assembly

**WARNING**

Make sure the bolt is in the forward position before you remove the backplate pin assembly. Failure to observe this warning will result in injury.

- (1) Place the safe/fire switch on fire (F).
- (2) Open the top cover.
- (3) Using the rim of a spent cartridge, pull the backplate pin straight out (figure 071-030-0001-2).

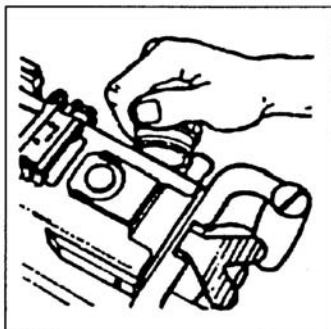

Figure 071-030-0001-2. Removal of backplate pin

- (4) Lift up slightly on the backplate assembly. Slowly pull the bolt and backplate assembly out of the receiver.
- (5) Support the bolt with one hand and maintain a controlled grip with the other hand. Lift the bolt up slightly and remove it (figure 071-030-0001-3).

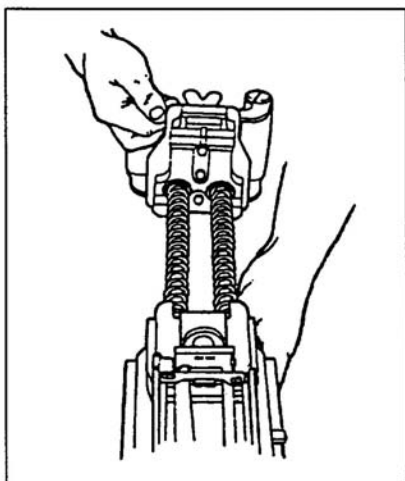

Figure 071-030-0001-3. Removal of bolt and backplate assembly

- c. Remove the primary drive lever and vertical cam assembly.

**CAUTION**

Do not rest the vertical cam assembly on its chromed surface.

- (1) Reach under the top of the receiver to locate the drive lever lock on the vertical cam assembly and slide the lock rearward about  $\frac{1}{4}$  inch (figure 071-030-0001-4).

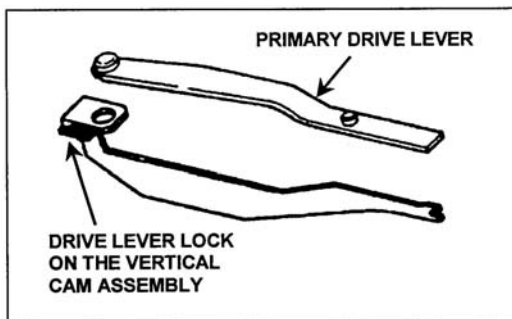

Figure 071-030-0001-4. Primary drive lever and vertical cam assembly

- (2) Press down on the primary drive lever's pivot post. This releases the primary drive lever and vertical cam assembly (figure 071-030-0001-5).

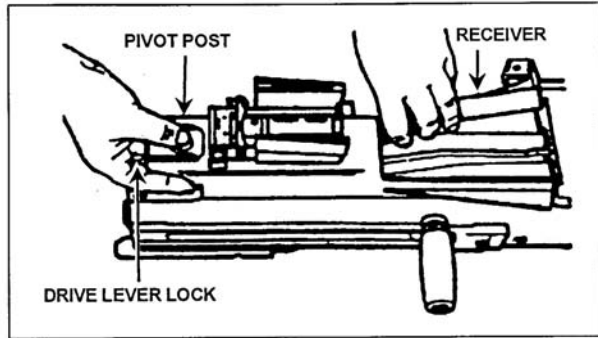

Figure 071-030-0001-5. Removal of the primary drive lever and vertical cam assembly

(3) Pull out the cam (to the rear) and the lever from the receiver.

d. Remove the secondary drive lever.

(1) Push down on the pivot post from the outside top cover. This releases the secondary drive lever (figure 071-030-0001-6).

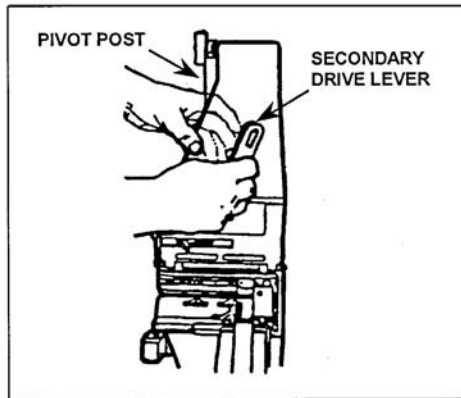

Figure 071-030-0001-6. Removal of the secondary drive lever

(2) Lift out the secondary drive lever from the top cover (figure 071-030-0001-7).

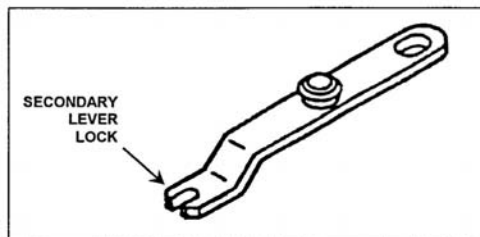
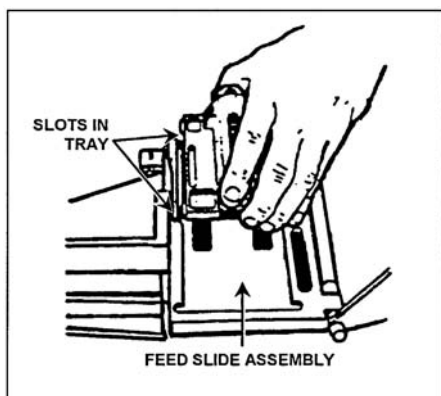

Figure 071-030-0001-7. Secondary drive lever

## Performance Steps

- e. Remove the feed slide assembly (figure 071-030-0001-8).



**Figure 071-030-0001-8. Removal of the feed slide assembly**

- (1) Pivot the tray that holds the feed slide assembly out of the top cover.
  - (2) Move the feed slide assembly to line up the tabs with the slots in the tray.
  - (3) Lift upward on the feed slide assembly.
- f. Remove the top cover assembly and feed tray (figure 071-030-0001-9).

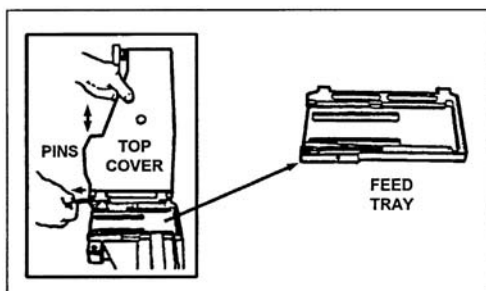

**Figure 071-030-0001-9. Removal of the top cover assembly and feed tray**

### CAUTION

Using your fingers only, not pliers, remove the top cover pins. Forcing the pin could break the small cross pin on the rod.

**Note:** The feed tray must be down for you to remove the top cover pins.

- (1) Hold the top cover straight up to align the end of the cross pin.
  - (2) Pull straight out on the pins.
  - (3) Lift off the top cover.
  - (4) Lift out the tray from the feeder.
- g. Remove the alignment guide assembly (figure 071-030-0001-10).

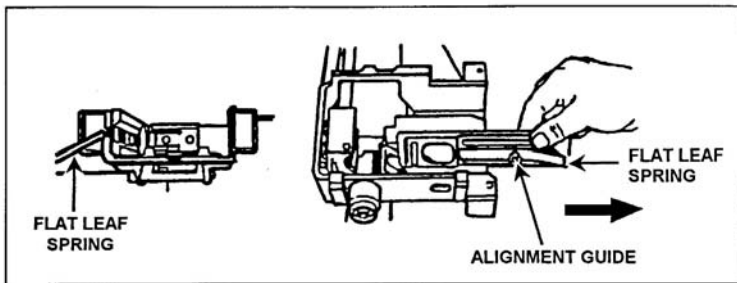

**Figure 071-030-0001-10. Removal of the alignment guide assembly**

- (1) Depress the flat leaf spring by using a cartridge link toggle (male end) or a small tool.
  - (2) Slide the alignment guide toward the feeder mouth.
  - (3) Pull rearward on the alignment guide and lift it out.
- h.** Remove the ogive plunger by pulling it out (figure 071-030-0001-11).

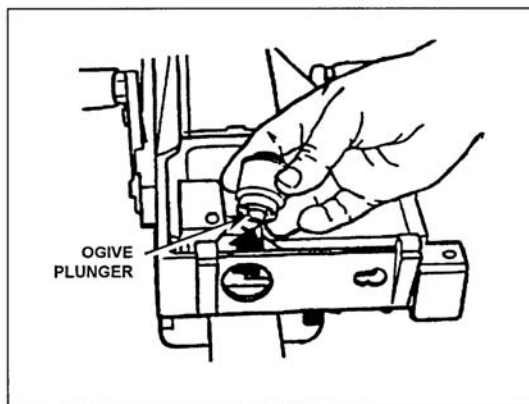

**Figure 071-030-0001-11. Removal of the ogive plunger**

- i.** Remove the round positioning block (figure 071-030-0001-12).

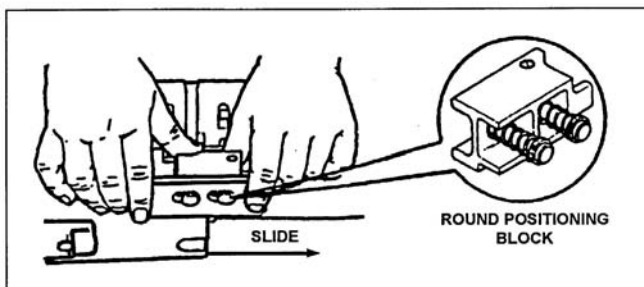
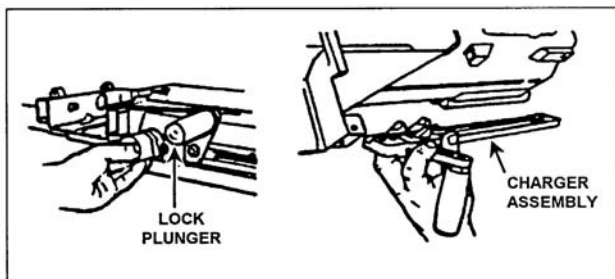

**Figure 071-030-0001-12. Removal of the round positioning block**

(1) Grasp the two control grips with both hands and lift up slightly to disengage the backplate from the locking lugs in the receiver.

(2) Pull the round positioning block toward the muzzle end of gun.

j. Remove the charger assemblies (both sides)(figure 071-030-0001-13).



**Figure 071-030-0001-13. Removal of the charger assembly**

(1) Rotate the charger handle up.

(2) Using either your fingers or a spent case, pry out the lip of the lock plunger.

(3) Lift up on the lock plunger to retract it; slide the charger assembly all the way to the rear.

(4) Pull the charger assembly away from the receiver.

k. Remove the receiver sear assembly (figure 071-030-0001-14).

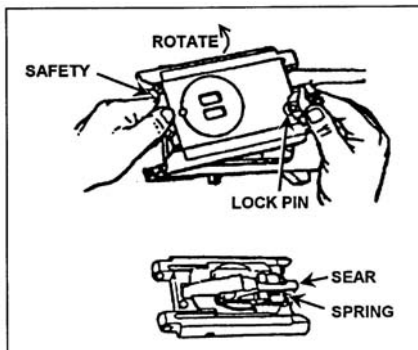

Figure 071-030-0001-14. Removal of the receiver sear assembly

- (1) Turn the receiver on its top. Put the safe/fire switch in the fire (F) position.
- (2) Lift up slightly on the lock pin with your fingers, using a cartridge link.
- (3) Squeeze the receiver sear (underneath the safety) and simultaneously rotate the sear housing assembly approximately 15 degrees in either direction.
- (4) Press down on the sear housing assembly and rotate the assembly until it stops (90 degrees from its original position).
- (5) Press the receiver sear and safety together while you put safe/fire switch on safe (S). This locks the sear in the down position and keeps you from accidentally losing the sear spring.
- (6) Lift out the sear housing assembly.

3. Clean the parts of the MK19.

*Note:* Do not reverse the direction of the bore brush while it is in the bore.

- a. Clean the receiver assembly (figure 071-030-0001-15).

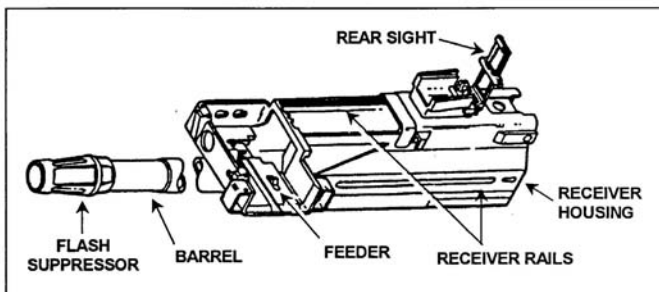

Figure 071-030-0001-15. Receiver assembly

- (1) Apply solvent to a rag or brush. Wipe or brush dirt away from all parts, especially the interior of the receiver housing, receiver rails, and feeder.
- (2) Swab out the bore and chamber, using a bore brush and RBC.

## Performance Steps

- (3) Wipe all parts dry.
- b. Clean the receiver sear assembly (figure 071-030-0001-14).
  - (1) Use only cleaning solvent on a rag or brush.
  - (2) Wipe or brush away dirt.
  - (3) Wipe dry.

### WARNING

Never immerse the sear housing assembly in solvent. Solvent may dilute the lubricant inside the sear housing.

- c. Clean the alignment guide assembly, ogive plunger, round positioning block, and secondary drive lever: wipe or brush off dirt and wipe dry.

### WARNING

Never immerse the ogive plunger assembly in solvent.

- d. Clean the charger assemblies.
    - (1) Apply cleaning solvent to a rag or brush, and wipe or brush off any dirt.
    - (2) Wipe dry.
  - e. Clean the vertical cam assembly, primary drive lever, feed slide assembly, and feed tray.
    - (1) Soak in cleaning solvent.
    - (2) Wipe or brush off dirt.
    - (3) Wipe dry.
  - f. Clean the top cover assembly.
    - (1) Apply cleaning solvent to a rag or brush and wipe or brush off dirt from all parts.
    - (2) Wipe all surfaces dry.
  - g. Clean the bolt and backplate assembly.
    - (1) Apply cleaning solvent to a rag or brush and wipe or brush off dirt from all parts.
    - (2) Wipe all surfaces dry.
4. Clean the components.
- a. Clean the T&E mechanism.
    - (1) Remove foreign matter with a clean, dry wiping rag.
    - (2) Use a small arms cleaning brush to clean the numbers on the scale.
  - b. Clean the M3 tripod, MK64 gun cradle mount, and pintle.
    - (1) Use a cleaning swab saturated with carbon removing compound to remove the dirt.
    - (2) Wipe all parts dry with clean wiping rags.



## Performance Steps

5. Clean ammunition: Remove foreign matter with a clean, dry wiping rag.
6. Inspect all MK19 parts for serviceability.
  - a. Receiver assembly.
    - (1) Check the receiver housing for cracks and rust.
    - (2) Check the receiver rails for burrs and cracked welds.
    - (3) Check the feeder pawls for burrs and lack of spring action. Check the pins for retention.
    - (4) Check the barrel for carbon buildup and pitting in the bore and chamber.
    - (5) Check the flash suppressor for dents, cracks, and erosion. Maintain minimal movement.
    - (6) Check the rear sight for rust, binding, and broken or bent parts.
  - b. Receiver sear assembly.
    - (1) Check for burrs on all parts.
    - (2) Closely inspect the rear shoulder for burrs.
  - c. Alignment guide assembly.
    - (1) Check the alignment guide spring for deformity, cracks, and looseness.
    - (2) Check the pin for breaks and cracks.
  - d. Ogive plunger assembly and round positioning block.
    - (1) Check the ogive plunger head for burrs and broken parts.
    - (2) Check the round positioning block for weak spring action and loose or broken parts.
  - e. Charger assembly (left and right).
    - (1) Check the grooved edges for burrs and bends.
    - (2) Check the latches for spring action on detects.
    - (3) Check the entire charger assembly for cracks, burrs, bends, and chips.
  - f. Vertical cam assembly and primary drive lever.
    - (1) Check the vertical cam assembly for bends, burrs, pits, scratches, and aluminum buildup on chromed surface (mirror-like surface).
    - (2) Check the drive lever lock for looseness or binding.
    - (3) Check the primary drive lever for burrs, especially around the pivot posts.
  - g. Secondary drive lever.
    - (1) Check for missing retaining ring from the pivot post.
    - (2) Check the pivot post and forked end for burrs.
  - h. Feed slide assembly and feed tray.
    - (1) Check the feed pawls and feed tray for burrs and binding.
    - (2) Check the guide rails for burrs.

## Performance Steps

- i. Top cover assembly.
    - (1) Check the top cover housing for cracks and rust.
    - (2) Check the latch for binding, looseness, and breaks.
  - j. Bolt and backplate assembly.
    - (1) Check the cocking lever for chips, burrs, and breaks.
    - (2) Check the guide rods for binding and bends.
    - (3) Check the recoil spring for weak action: Position the bolt end against a hard, flat surface and push up and down on the backplate assembly.
    - (4) Check the backplate pin for a missing retaining spring.
    - (5) Check for a missing, loose, or broken safety wire.
  - k. Report any deficiencies to your supervisor.
7. Inspect all components for serviceability.
- a. T&E mechanism.
    - (1) Inspect the handwheels for smooth operation and rust. Check the threads for burrs and rust.
    - (2) Check the traversing slide lock for spring action. Make sure the elevating mechanism sleeve fits on the traversing bar and clamps firmly.
    - (3) Check the traversing and elevating scales for legibility.
    - (4) Inspect the quick-release pin and chain for burrs and rust; check for missing spring-loaded balls.
  - b. M3 Tripod.
    - (1) Check for completeness of the tripod; make sure all nuts and bolts are tightly secured.
    - (2) Check for cracks on the legs and tripod head.
    - (3) Check for a missing, broken, or inoperative lock latch.
    - (4) Check the pintle lock release cam for correct operation.
    - (5) Check the locking action of the front leg clamping assembly.
    - (6) Make sure the rear legs lock in the open position, the sleeve latch notch and the right leg slide notch engage completely, and the latch spring has good tension.
    - (7) Check the telescoping, indexing, and locking actions of rear legs and front leg locking assembly.
  - c. MK64 gun cradle mount.
    - (1) Check for missing or damaged parts.
    - (2) Check for rust, cracks, and burrs.
    - (3) Inspect the pintle lock assembly for the nut, bolt, and cotter pin. Check the pintle surface for burrs and rust.
  - d. Report any deficiencies to your supervisor.
8. Inspect ammunition for damage and corrosion. Turn in any unserviceable ammunition.

## Performance Steps

9. Lubricate the MK19 and components. Do not use CLP, and do not mix lubricants.

### CAUTION

- Never immerse the sear housing, ogive plunger, or bolt assemblies in cleaning solvent. Solvent could dilute the lubricant or grease inside.
- Never lubricate the MK19 with CLP.
- Avoid mixing lubricants.
- Completely wipe off all excess lubricant.

a. Lubricate lightly to moderately with LSAT, LSA, or GMD (never CLP). In cold weather (-25 to 0 degrees Fahrenheit), use LSAT, LSA, GMD, or LAW. In extra cold weather (below -25 degrees Fahrenheit), use LAW.

b. Apply lubricant to all weapon parts and surfaces except charger handles. Work in the lubricant by moving the parts.

c. Lubricate all components and wipe them with a clean, dry rag to remove excess oil.

10. Assemble the MK19 machine gun.

a. Attach the charger assemblies (both sides)(figure 071-030-0001-16).

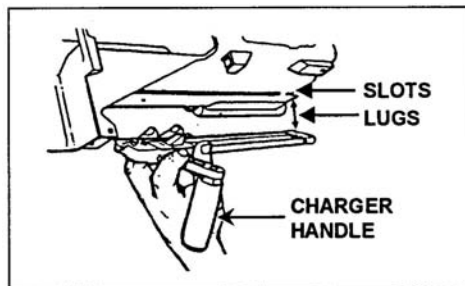

Figure 071-030-0001-16. Attachment of the charger assemblies

- (1) Turn the receiver upright.
- (2) Rotate the charger handles to the straight-up position.
- (3) Line up the lugs on the charger with the slots in the receiver rail.

Insert the charger lugs into the slots.

(4) Hold the charger tightly against the rail. Slide the charger forward until it locks into place.

b. Attach the round positioning block (figure 071-030-0001-17).

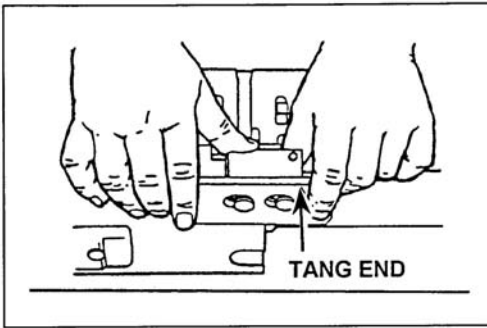

**Figure 071-030-0001-17. Attachment of the round positioning block**

- (1) Insert the blocks into the slots with the tang end forward.
- (2) Push against the block and slide it toward the rear until the block locks into place.

- c. Insert the ogive plunger assembly into the opening.
- d. Insert the alignment guide assembly (figure 071-030-0001-18).

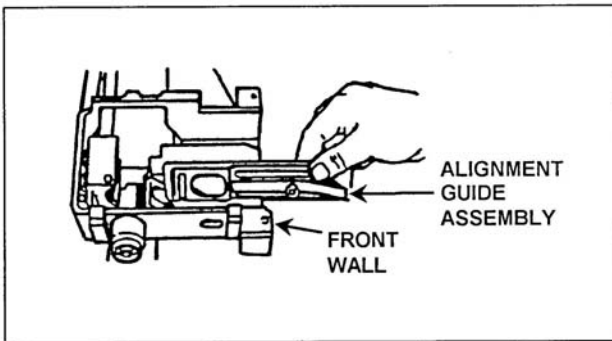

**Figure 071-030-0001-18. Insertion of the alignment guide assembly**

- (1) Position the alignment guide assembly so that the pin is lined up with the slot in the feeder wall.
- (2) Hold the alignment guide against the front wall and slide the alignment guide into the receiver until it clicks.

- e. Attach the feed tray and feed slide assembly (figure 071-030-0001-19).

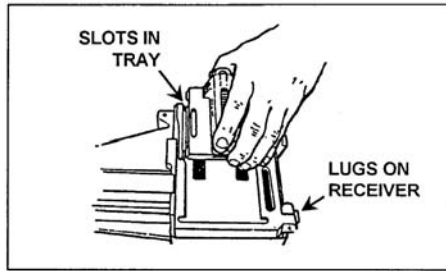

**Figure 071-030-0001-19. Attachment of the feed slide assembly**

- (1) Place the tray in the top of the feeder, recessed side up.
  - (2) Ensure that the pinholes on the tray line up with the lugs on the receiver.
  - (3) Position the feed slide assembly by lining up the tabs with the slots on the tray.
  - (4) Insert the tabs into the slots. Drop the feed slide assembly into the tray and move it slightly to ensure engagement.
- f. Attach the top cover assembly (figure 071-030-0001-20).

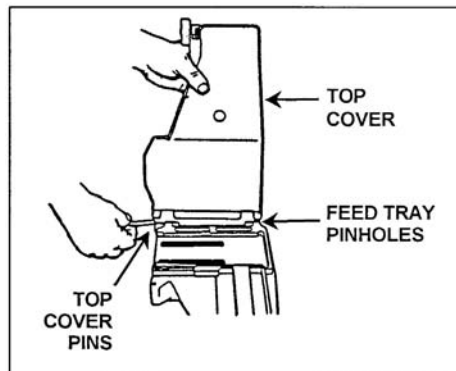

**Figure 071-030-0001-20. Attachment of the top cover assembly**

- (1) Ensure that the feed tray is in the proper place in the receiver.
- (2) Place the top cover on the receiver. Line up the pinholes on the cover with the receiver's lug end and the pinholes on the feed tray.
- (3) Hold the top cover straight up. Insert the top cover pins on both sides. Fully insert the cross pin. Rotate the top cover so that it is fully open.

**WARNING**

To avoid breaking the cross pin, insert it fully into the receiver before closing the top cover.

- g. Engage the secondary drive lever (figure 071-030-0001-21).

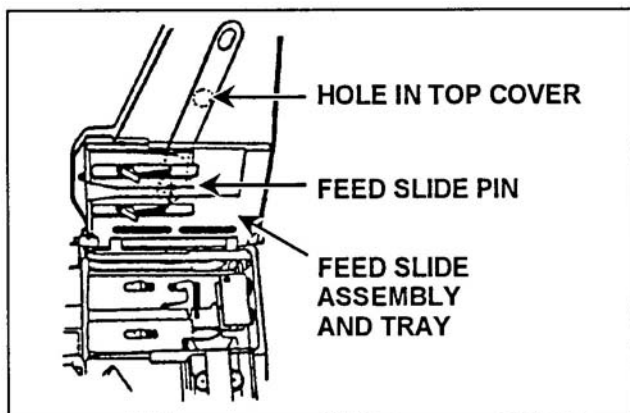

Figure 071-030-0001-21. Engaging the secondary drive lever

- (1) Rotate the feed slide assembly and tray upward.
- (2) Engage the forked end of the secondary drive lever with the feed slide pin.
- (3) Press the raised pivot post through the hole in the stop cover.
- (4) Press the secondary drive lever against the top cover until it locks into place.

**CAUTION**

Engage the secondary drive lever with the feed slide pin, or the gun will not fire.

- h. Engage the vertical cam assembly (figure 071-030-0001-22).

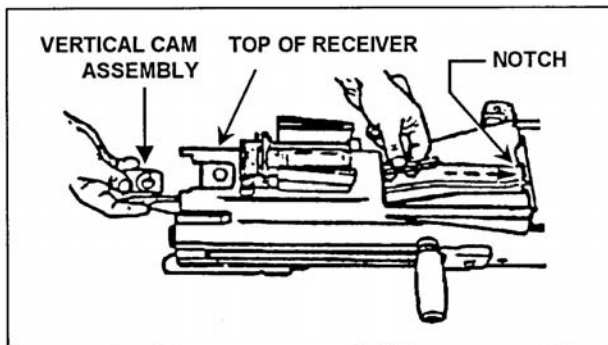
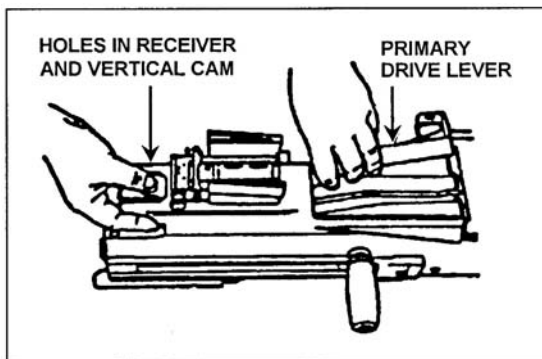

Figure 071-030-0001-22. Engagement of the vertical cam assembly

- (1) Slide the vertical cam assembly through the rear of the receiver. The raised portion should slide over the top of the receiver. The drive lever lock should be underneath.
- (2) Engage the forked end in the notch.

- i. Engage the primary lever (figure 071-030-0001-23).



**Figure 071-030-0001-23. Engagement the primary drive lever**

- (1) Hold the vertical cam assembly in place and slide the primary drive lever into the receiver.
  - (2) Slide the primary drive lever lock to the rear and engage the pivot post lever through the holes in the receiver and vertical cam.
  - (3) Slide the primary drive lever lock forward. (The primary drive lever lock is located on the vertical cam just beneath the top of the receiver).
- j. Insert the bolt and backplate assembly (figure 071-030-0001-24).

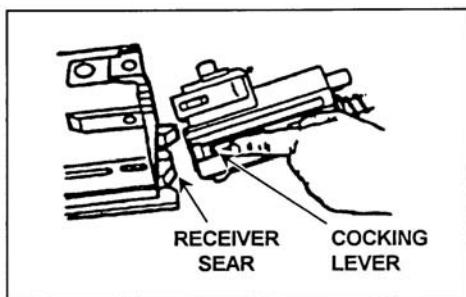

**Figure 071-030-0001-24. Insertion of the bolt and backplate assembly**

- (1) Place the safe/fire switch in the fire (F) position.
- (2) Press the receiver sear using your thumbs or the rim of a cartridge case.
- (3) Make sure the cocking lever is cocked and forward.
- (4) Slide the bolt and backplate assembly all the way forward.
- (5) Insert the backplate pin to lock the assembly in place.
- (6) Close the cover.

**WARNING**

Before inserting the bolt and backplate assembly, put the cocking lever in the forward position.

**CAUTION**

Before closing the top cover, always make sure the secondary drive lever engages the feed slide pin, the feed slide assembly is to the left, and the bolt is forward. Never try to force the top cover closed. Doing so could damage the weapon.

- k. Attach the receiver sear assembly (figure 071-030-0001-25).

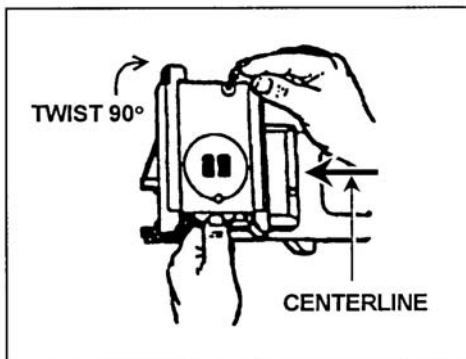

**Figure 071-030-0001-25. Attachment of the receiver sear assembly**

- (1) Turn the receiver over on its top.
- (2) Place the sear housing on the receiver and line up the sear housing assembly at a right angle to the barrel center line.
- (3) Put the safe/fire switch on fire (F) position.
- (4) Press down and rotate the housing assembly until it stops.
- (5) Press up on the sear and rotate it until it locks in position.

- l. Attach the feed throat assembly.

- (1) Squeeze the grip pins and align them with the holes in the receiver.
- (2) Release the grip pins to attach the feed throat.

11. Perform a function check to make sure you have assembled the weapon correctly.

**Evaluation Preparation:** *Setup:* At the test site, provide the Soldier with the equipment listed in the task condition statement. Use the performance steps in the training outline to evaluate the Soldier's performance of the task.

*Brief Soldier:* Tell the Soldier to perform operator-level maintenance on the MK19 and to perform a function check to ensure that the weapon functions correctly.

Performance Measures	GO	NO GO
1. Cleared the weapon.	___	___
2. Disassembled the weapon without damaging any parts.	___	___



Performance Measures	GO	NO GO
3. Cleaned the weapon parts.	_____	_____
4. Cleaned the components.	_____	_____
5. Cleaned the ammunition.	_____	_____
6. Inspected all parts, components, and ammunition for serviceability.	_____	_____
7. Reported all deficiencies to your supervisor.	_____	_____
8. Lubricated the weapon parts and components using the correct lubricant and lubrication techniques.	_____	_____
9. Assembled the weapon in the correct sequence without damaging any parts.	_____	_____
10. Performed a function check.	_____	_____

**Evaluation Guidance:** Refer to chapter 1, paragraph 1-9e, (1) and (2).

**References**

**Required:**

**Related:** FM 3-22.27 and TM 9-1010-230-10

## 071-030-0004

### Engage Targets with an MK19 Machine Gun

**Conditions:** Given a zeroed MK19 machine gun (tripod- or cupola-mounted), linked 40-mm grenade ammunition, and a sector of fire with engageable targets.

**Standards:** Fire the MK19 machine gun to engage targets in your assigned sector of fire. Apply correct machine gun target engagement techniques so that each target is covered with fire.

#### Performance Steps

1. Assume a suitable firing position. Based on your situation, select a firing position that will allow you to observe and engage targets yet minimize your exposure to enemy fire.
  - a. Seated firing positions. Sit directly behind the weapon between the trail legs of the tripod.
    - (1) Legs extended. Extend your legs under the tripod (figure 071-030-0004-1).

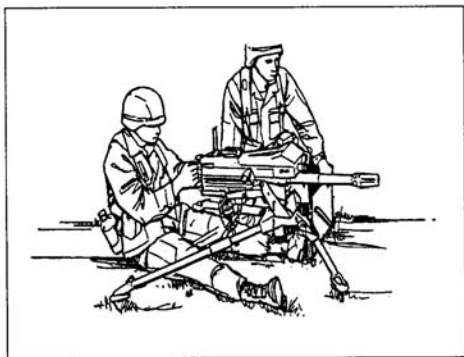

Figure 071-030-0004-1. Seated firing position, legs extended

(2) Legs crossed. Cross your legs and place your elbows on the inside of your thighs for support when firing the weapon (figure 071-030-0004-2).

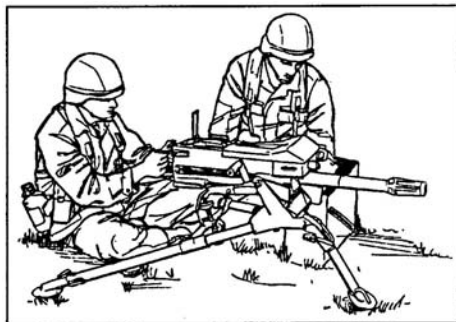

Figure 071-030-0004-2. Seated firing position, legs crossed

(3) Legs braced. Extend your legs, brace them on the trail legs of the tripod, and place your elbows on the inside of your thighs for support (figure 071-030-0004-3).

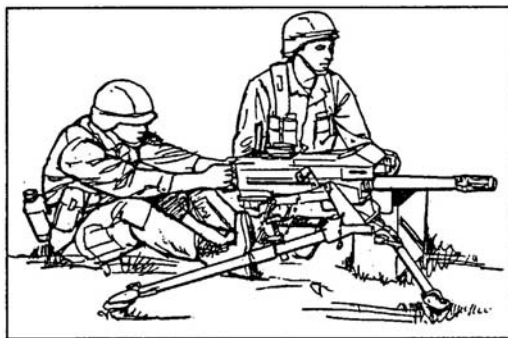

Figure 071-030-0004-3. Seated firing position, legs braced

## Performance Steps

b. Kneeling position. Kneel and grasp the control grips with your thumbs on the trigger (figure 071-030-0004-4).



Figure 071-030-0004-4. Kneeling position

c. Standing position. Use for gun mounted on a vehicle pedestal (figure 071-030-0004-5).

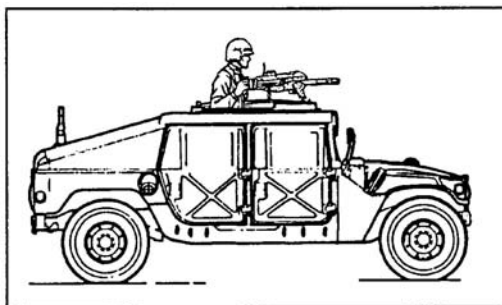

Figure 071-030-0004-5. Standing position for mounted gun

2. Acquire the target using correct sight alignment.
3. Apply the correct engagement technique based on target types.
  - a. Use the correct gun manipulation technique (figure 071-030-0004-6).
    - (1) Fixed fire. This is fire delivered against a point target. Only one aiming point is necessary with little or no manipulation of the gun.
    - (2) Traversing fire. This is fire distributed against a wide target requiring successive changes in direction of gun, which means using the traversing and elevation (T&E) mechanism to traverse the gun left or right to distribute fire laterally.
    - (3) Searching fire. This is fire delivered against a deep target or a linear target with depth in width by successive changes in elevation, which means using the T&E mechanism to move the muzzle of the weapon up or down to distribute fire in depth.

## Performance Steps

(4) Traversing and searching fire. This is fire delivered in width and depth by successive changes in direction and elevation. It is employed against a target where the long axis is oblique to the direction of fire.

(5) Swinging traverse. This is fire delivered against targets that require major changes in direction but little or no change in elevation. Loosen the traversing slide lock enough to swing the gun laterally.

(6) Free gun. This is fire delivered against moving targets that must be rapidly engaged with fast changes in direction and elevation. To fire free gun, remove the T&E mechanism.

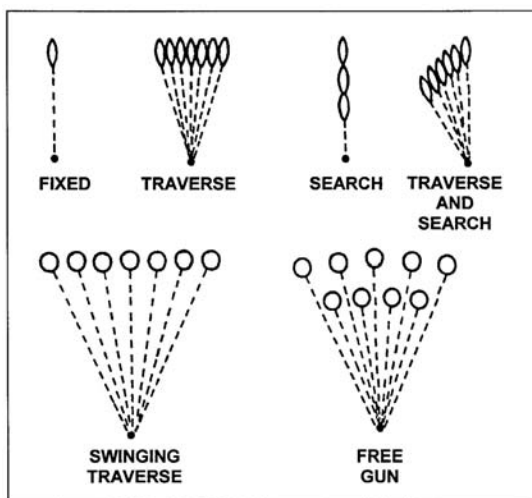

Figure 071-030-0004-6. Techniques of fire with respect to the MK19

b. Use the correct application of fire to engage specific targets.

(1) Point target. Engage point targets with fixed fire using a single aiming point (figure 071-030-0004-7).



Figure 071-030-0004-7. Point target

(2) Linear target. Initially aim just outside of either flank or fire. Traverse fire back and forth from flank to flank, covering the entire target area (figure 071-030-0004-8).

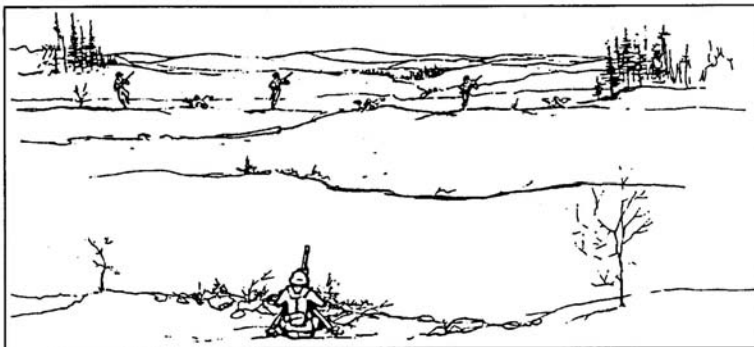

Figure 071-030-0004-8. Linear target

(3) Linear target with depth. Initially aim at the near flank with range set to the midpoint of the target unless another portion of the target is more critical or presents a greater threat. Fire on the near flank, then traverse and search back and forth, covering the entire target (figure 071-030-0004-9).



Figure 071-030-0004-9. Linear target with depth

(4) Deep target. Initially aim at the end of the target closest to the gun, unless another portion of the target is more critical or presents a greater threat (auto rifleman). Fire and search up the far end and back again repeatedly (figure 071-030-0004-10).



Figure 071-030-0004-10. Deep target

(5) Area target. Initially aim at the midpoint of the target area. Traverse and search to either flank, then traverse and search to the opposite flank (figure 071-030-0004-11).

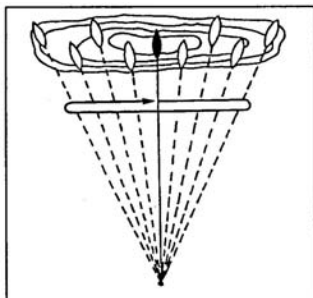

Figure 071-030-0004-11. Engagement of area targets, single gun

4. Use observation of fire and adjusted aiming point to place effective fire on the target.

a. Observation of fire. Observe the strike of the rounds in relation to the target; adjust elevation and direction needed to move the center of impact onto the target.

*Note:* This does not call for use of the sights.

Example: Suppose you fire at a target 500 meters away. The rounds impact 20 meters short and 50 meters right. To manipulate the gun onto the target, use the T&E mechanism handwheels to move the muzzle left and up the proper number of clicks.

b. Adjusted aiming point. Use this method to quickly adjust fires without making a sight or T&E adjustment (figure 071-030-0004-12).

(1) If the initial burst misses the target, rapidly select a new aiming point the same distance from the center of impact of the initial burst but in the opposite direction.

(2) Lay the gun on that aiming point and fire.

**Performance Steps**

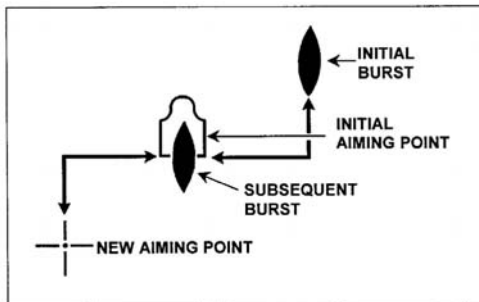

**Figure 071-030-0004-12. Adjusted aiming point method**

5. Fire on the targets until they are destroyed or until you receive an order to cease fire.

**Evaluation Preparation:** *Setup:* Evaluate this task on a live-fire range designed for 40-mm machine gun firing. For a tripod-mounted MK19, tell the Soldier to fire table 2, tasks 4 through 8, FM 23-27, appendix C. For a vehicle-mounted MK19, tell the Soldier to fire table 3, tasks 2 through 5, FM 23-27, appendix C.

*Brief Soldier:* Tell the Soldier to perform the tasks outlined in appendix C, FM 23-27. Brief the Soldier on the task conditions, standards, and ammunitions. Tell the Soldier he/she will be evaluated on his/her ability to apply correct target engagement techniques and place effective fire on targets.

<b>Performance Measures</b>	<b>GO</b>	<b>NO GO</b>
1. Assumed a suitable firing position.	___	___
2. Applied the correct engagement technique based on the target type.	___	___
a. Used the correct gun manipulation technique.		
b. Used the correct application of fire to engage specific targets.		
3. Placed effective fire on targets (scored a minimum of 84 points).	___	___
4. Used the correct application of fire to engage specific targets.	___	___
5. Used observation of fire and adjusted aiming point to place effective fire on the target.	___	___

**Evaluation Guidance:** Refer to chapter 1, paragraph 1-9e, (1) and (2).

**References**

**Required:**

**Related:** FM 23-27

## 071-030-0005

### Load an MK19 Machine Gun

**Conditions:** Given a can of linked 40-mm grenade ammunition and a cleared MK19 machine gun mounted on an M3 tripod or on a vehicle. (If firing from a vehicle, the ammunition can bracket must be attached to the gun mount.)

**Standards:** Load linked ammunition through the feed throat into the feeder so that when the cover is closed, the round is straight and firmly seated against the bolt and the ammunition feeds correctly.

#### Performance Steps

1. Make sure the chamber is empty, the bolt is in the forward position, and the charger handles are in the up (lock) position.
2. Make sure the safety switch is in the safe (S) position.

#### WARNING

Do not let the top cover slam shut from the open position. Injury to personnel or damage to equipment could result.

3. Insert the first round.
  - a. Open the top cover and insert the first round through the feed throat into the feeder, link opening first (figure 071-030-0005-1).

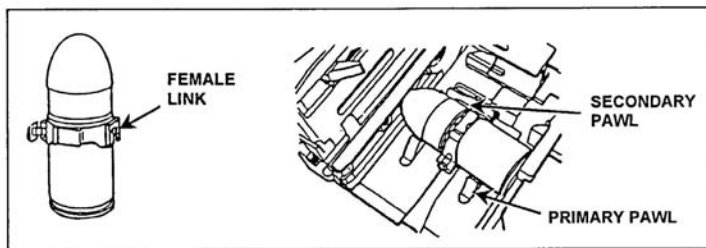

Figure 071-030-0005-1. Insertion of first round through feed throat

- b. Push or slide the round across the first set of feeder pawls, making sure the round is straight and firmly seated against the bolt (figure 071-030-0005-2).



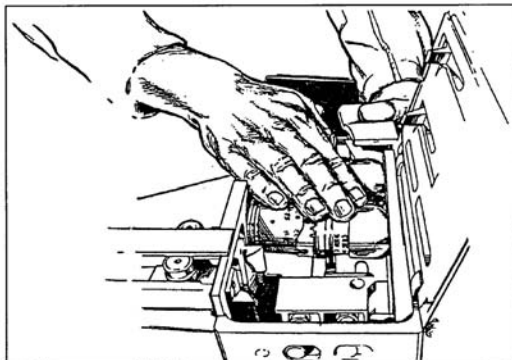

Figure 071-030-0005-2. Pushing round across feeder pawls

- c. Index the feed slide assembly to the left and close the top cover (figure 071-030-0005-3).

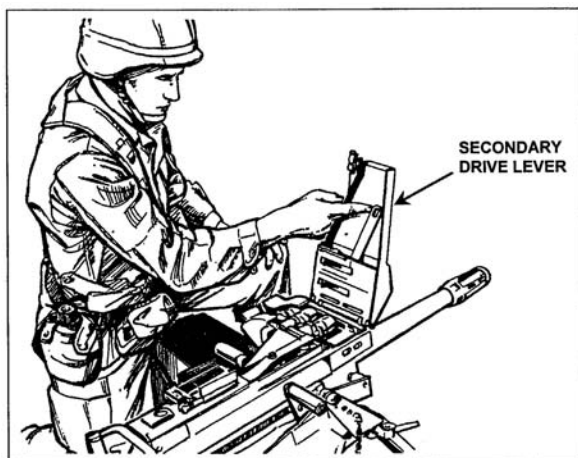

Figure 071-030-0005-3. Indexing the feed slide assembly

4. Charge the weapon (figure 071-030-0005-4).
  - a. Grasp the charger handles palms down.
  - b. Press the charger handle locks and rotate the charger handles down.
  - c. Pull the charger handles sharply to the rear until the bolt seats.
  - d. Push the charger handles forward and rotate them up into the lock position.

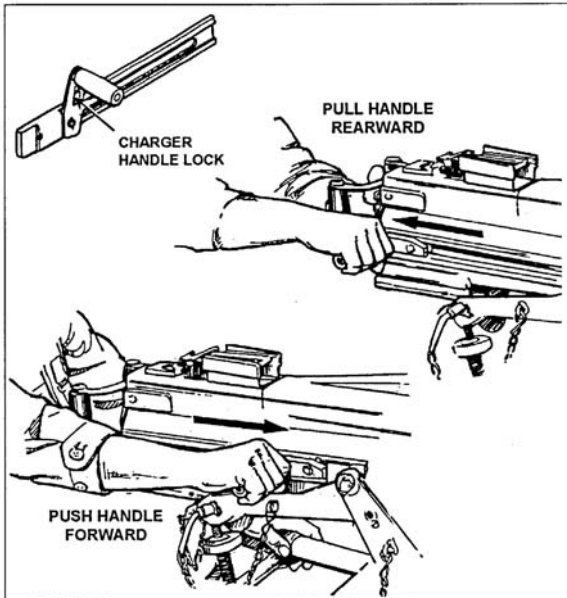

Figure 071-030-0005-4. Charging the MK19 machine gun

5. Load the first round.
  - a. Place the safety switch in the fire (F) position and press the trigger.

*Note:* The bolt will move forward and load the first round on the bolt face (half load).

  - b. Rotate the charger handles down and pull them sharply to the rear until the bolt seats. This pulls the bolt with the loaded round into position for firing (full load).
  - c. Place the safety switch in the safe (S) position.
  - d. Push the chargers forward and rotate the charger handles up into the lock position. The weapon is fully loaded.
  - e. Leave the safety switch on the safe (S) position until ready to fire.

**WARNING**

For firing, charger handles must be FORWARD and UP. Keep your weapon pointed downrange and the line-of-fire clear of objects.

**Evaluation Preparation:** *Setup:* Provide the Soldier with the equipment listed in the task conditions statement.

*Brief Soldier:* Tell the Soldier to load the MK19 according to the proper procedures.

Performance Measures	GO	NO GO
1. Made sure the chamber was empty, the bolt was forward, and the charger handles were in the lock position.	_____	_____
2. Made sure the safety switch was in the safe (S) position.	_____	_____
3. Inserted the first round. a. Opened the top cover and inserted the first round through the feed throat and into the feeder, link opening first. b. Pushed or slid the round across the first set of feeder pawls; made sure the round was straight and firmly seated against the bolt. c. Indexed the feed slide assembly to the left and closed the top cover.	_____	_____
4. Charged the weapon. a. Grasped the charger handles palms down. b. Pressed the charger handle locks and rotated charger handles down. c. Pulled the charger handles sharply to the rear until the bolt seated. d. Pushed the charger handles forward and rotated them up into the lock position.	_____	_____
5. Loaded the first round. a. Placed the safety switch on the fire (F) position and pressed the trigger. b. Rotated the charger handles down and pulled them sharply to the rear until the bolt seated. c. Placed the safety switch on the safe (S) position. d. Pushed the charger forward and rotated the charger handles up into the locked position. e. Left the safety switch in the safe (S) position until ready to fire.	_____	_____

**Evaluation Guidance:** Refer to chapter 1, paragraph 1-9e, (1) and (2).

**References**

**Required:**

**Related:** FM 23-27 and TM 9-1010-230-10

---

## 071-030-0006

### Unload an MK 19 Machine Gun

**Conditions:** Given an MK19 machine gun mounted on an M3 tripod or vehicle and loaded with linked 40-mm grenade ammunition.

**Standards:** Unload the MK19 machine gun, remove ammunition and empty casings. Clear the weapon; make sure the chamber is empty and the safety switch is in the safe (S) position.

#### Performance Steps

1. Place the safety switch on the safe (S) position.
2. Charge the weapon.
3. Return the charger handles to the forward position and rotate only one charger handle up.
4. Remove the live round or spent case from the bolt.
  - a. Insert the tip of a cleaning rod through the right handrail as close to the bolt face as possible (figure 071-030-0006-1).

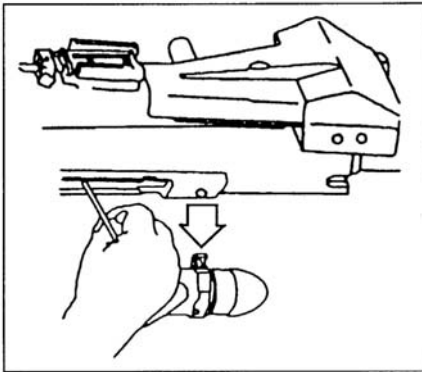
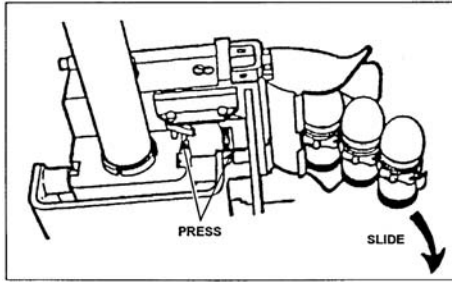

Figure 071-030-0006-1. Removal of round or spent case

- b. Lift up on the cleaning rod to force the live round or case off the bolt face and out the bottom of the gun. Catch the live round or the spent case as it falls out.
5. Remove the linked rounds from the feeder.
    - a. Open the top cover. Check for rounds in the feeder. If you find any rounds in the feeder, perform the following actions (figure 071-030-0006-2).
-



**Figure 071-030-0006-2. Removal of linked rounds from the feeder**

- (1) With one hand, reach beneath the feeder. Press the primary and secondary positioning pawls at the same time.
- (2) At the same time, slide the linked rounds out of the feeder and feed throat.
  - b. Place linked rounds in the ammunition can.
6. Place the safety switch in the fire (F) position.
7. Ride the bolt forward.
  - a. Hold one charger handle to the rear.
  - b. Press the trigger to release the bolt; ride the bolt forward.
  - c. Make sure both charging handles are forward and in the up position.
8. Place the safety switch in the safe (S) position.
9. Index the feed slide assembly to the left.
10. Close and latch the top cover.

**Evaluation Preparation:** *Setup:* Provide the Soldier with the equipment listed in the task conditions statement.

*Brief Soldier:* Tell the Soldier to unload the MK19 according to the task steps.

Performance Measures	GO	NO GO
1. Placed the safety switch on the safe (S) position.	___	___
2. Charged the weapon.	___	___
3. Returned the charger handles to the forward position and rotated only one charger handle up.	___	___
4. Removed the live round or spent case from the bolt. <ol style="list-style-type: none"> <li>a. Inserted the tip of a cleaning rod through the right handrail as close to the bolt face as possible.</li> </ol>	___	___

Performance Measures	GO	NO GO
<ul style="list-style-type: none"> <li>b. Raised up on the cleaning rod to force the live round or case off the bolt face and out the bottom of the gun. Caught the live round or the spent case as it fell out.</li> </ul>		
5. Removed any linked rounds from the feeder.	___	___
<ul style="list-style-type: none"> <li>a. Opened the top cover. Checked for rounds in the feeder. If rounds were found in the feeder, performed the following actions: <ul style="list-style-type: none"> <li>(1) With one hand, reached beneath the feeder and pressed the primary and secondary positioning pawls at the same time.</li> <li>(2) At the same time, slid the linked rounds out of the feeder and feed throat.</li> </ul> </li> <li>b. Placed the linked rounds in the ammunition can.</li> </ul>		
6. Placed the safety switch on the fire (F) position.	___	___
7. Rode the bolt forward.	___	___
<ul style="list-style-type: none"> <li>a. Held one charger handle to the rear.</li> <li>b. Pressed the trigger to release the bolt, and rode the bolt forward.</li> <li>c. Made sure both charging handles were forward and in the up position.</li> </ul>		
8. Placed the safety switch on safe (S) position.	___	___
9. Indexed the feed slide assembly to the left.	___	___
10. Closed and latched the top cover.	___	___

**Evaluation Guidance:** Refer to chapter 1, paragraph 1-9e, (1) and (2).

**References**

**Required:**

**Related:** FM 3-22.27 and TM 9-1010-230-10

**071-030-0007**

**Perform a Function Check on an MK19 Machine Gun**

**Conditions:** Given a cleared MK19 machine gun mounted on an M3 tripod or vehicle carrier.

**Standards:** Conduct an operational check of the MK19 machine gun; ensure it is correctly assembled and functions properly.

**WARNING**

Before performing any procedure, make sure the weapon is cleared of ammunition.

1. Check the functioning of the safety switch.
  - a. With the cover closed, place the safety switch on the safe (S) position.
  - b. Pull the bolt to the rear, push the charger handles to the forward position, and rotate the handles up.
  - c. Press the trigger. The bolt should not go forward.
  - d. Place the safety switch on the fire (F) position.
  - e. Press the trigger. The bolt should spring forward.
  - f. Place the safety switch on the safe (S) position and leave the bolt in the forward position.
2. Open the top cover assembly and inspect the feed tray assembly and the chamber to ensure that the gun is clear.
  - a. Open the top cover.
  - b. Touch the firing pin. If it is not protruding, recharge and release the bolt spring under pressure.
  - c. Inspect the bolt face to make sure it is not worn, dirty, pitted, corroded, or in need of lubrication.

**WARNING**

Do not allow the top cover to slam shut from the raised position. Doing so could injure your hand or damage the equipment.

3. Check the feed slide assembly and feeder.
  - a. Move the secondary drive lever back and forth. The feed slide assembly should move freely.
  - b. Press the feed pawls to check for spring pressure.
  - c. Inspect the link guide for roughness and galling.

**Note:** Before closing the top cover, always make sure of the following:

- The secondary drive lever is engaged with the feed slide pin.
- The feed slide assembly is to the left.
- The bolt is forward.

**Note:** Never try to force the top cover closed. Doing so could damage the equipment.

## Performance Steps

- d. Close and latch the top cover.
4. If you find any deficiencies that you cannot correct, the MK19 is unserviceable. Report the deficiencies to your supervisor.

**Evaluation Preparation:** *Setup:* At the test site, provide the Soldier with the equipment listed in the task conditions.

*Brief Soldier:* Tell the Soldier to perform a function check to determine if the MK19 machine gun functions properly.

Performance Measures	GO	NO GO
1. Checked the functioning of the safety switch.	___	___
2. Inspected the interior of the receiver assembly for missing or damaged parts.	___	___
3. Checked the feed slide assembly and feeder.	___	___
4. Reported deficiencies to the supervisor.	___	___

**Evaluation Guidance:** Refer to chapter 1, paragraph 1-9e, (1) and (2).

### References

#### Required:

**Related:** TM 9-1010-230-10

## 071-030-0008

### Correct Malfunctions of an MK19 Machine Gun

**Conditions:** Given a loaded MK 19 machine gun mounted on an M3 tripod or vehicle, linked 40-mm grenade ammunition, a caliber .50 cleaning rod, a bore obstruction device (BOD), an assistant gunner, rifle bore cleaner (RBC), lubricating oils (LSA and either LSAT or lubricating oil arctic weather [LAW]), grease (GMD), cleaning solvent (PD680), wiping rags, cloth (abrasive crocus), cleaning rod assembly, small-arms cleaning brushes, and one of the following situations: the weapon has failed to fire; the weapon is firing sluggishly; or the weapon has uncontrolled fire (continues to fire after the trigger is released).

**Standards:** Take immediate action on an MK19 machine gun that fails to fire without identifying the cause of the malfunction; if immediate action is unsuccessful, perform remedial action to identify the cause of the malfunction. Take immediate action to secure a runaway MK19 machine gun; take remedial action to eliminate the malfunction; and take corrective action for an MK19 machine gun that is firing sluggishly.

## Performance Steps

1. Apply immediate action when the weapon fails to fire (during peacetime and during training).



## Performance Steps

*Note:* Clear all nonessential personnel away from the gun position.

### DANGER

**1. If anything unusual occurs during firing (including short recoil, out of battery, excess smoke, flash, loud or muffled report, malfunction, or stoppage), immediately inspect the weapon. Clear the weapon. Check the barrel for obstruction. Check the feeder, bolt face, and receiver for damage or unusual debris. Do NOT try to clear an obstructed bore. To get assistance, follow the instructions in the local or unit SOP. Continued firing may cause death or injury.**

**2. Do NOT relink or fire ammunition that has been cycled through the weapon.**

### WARNING

- Clear all nonessential personnel away from the gun position.
- If, when you fire a round, you—
  - Hear a muffled sound;
  - See excess smoke coming out of the chamber area;
  - See excess debris, gas, or both coming from below the gun—
    - DO NOT perform immediate action.
    - DO notify your supervisor.

- a. Keep the weapon pointed at the target.
  - b. Pull the bolt to the rear to charge the weapon and have the assistant gunner catch the live round as it is ejected.
  - c. If the weapon will not charge, stop immediate action and apply remedial action to clear a jammed bolt (step 2b).
  - d. Push the charging handles forward and up.
  - e. Place the safety switch in the safe (S) position.
  - f. Check for bore obstruction.
- (1)** Make sure the safety switch is on safe (S).
-

**WARNING**

- Do NOT let the bolt go forward—this could cause a round to fire accidentally.
- Do NOT insert your hands into the receiver with the bolt locked to the rear on sear. If you do so, you could suffer a severe injury.
- Do make sure the safe/fire switch is in the safe (S) position.

(2) Lower the charging handles, maintain your grip, and apply back pressure to the bolt.

(3) Have the assistant gunner open the top cover and check the bolt face for a live round.

(4) If a live round, spent case, or debris is present—

(a) Have the assistant gunner remove the catch bag and be prepared to catch any live ammunition that falls from the bottom of the weapon.

(b) Charge the bolt completely until the bolt clicks (locks) to the rear. Return the handles to the forward position, handles down.

(c) If a round is still present, have the assistant gunner clear it from the bolt face by inserting a cleaning rod through the slot in the charger handle assembly and catching the round.

(d) Have the assistant gunner place the bore obstruction device (BOD) into the chamber end of the barrel (weighted end first).

(e) Snake the BOD into the barrel.

(f) If the cable stops feeding, pull it back and push it forward again.

(g) If you cannot push the cable forward any farther, the bore is obstructed. STOP. Notify your supervisor at once.

**WARNING**

If you find that the bore of the weapon is obstructed, notify your supervisor and follow your unit standing operating procedure (SOP). Never try to remove an obstructing round from the bore. Only trained and qualified personnel should do so. Do NOT transport a weapon with a projectile lodged in the bore.

(5) If you are able to insert the BOD cable through the barrel so that you see the weighted end of the cable protruding from the flash suppressor, then the barrel is clear.

(6) Move the safety switch to the fire (F) position and try to fire.

(7) If the weapon does not fire, put the safety switch on safe (S) and wait 10 seconds.

(8) Pull the bolt to the rear. Have the assistant gunner catch the live round as it ejects.

(9) Notify your supervisor.

## Performance Steps

2. Apply immediate action during combat.
  - a. Press the charger handle locks, and rotate the charger handles down.
  - b. Pull the charger handles to the rear until the bolt seats.
  - c. Push the charger handles forward and rotate them up.
  - d. Relay the gun and fire.
  - e. If the gun fails to fire, apply remedial action.

### WARNING

Do not use combat misfire procedures during peacetime or training. Serious injury can result if you do not observe precautions.

*Note:* Both charger handles must be forward and up for firing. If either handle is down, the gun will not fire.

3. Apply remedial action to correct malfunctions.
  - a. Correct sluggish operation of an MK19 machine gun.
    - (1) Clean the weapon and perform operator-level maintenance.
    - (2) Check the recoil springs for weakness and bent guide rods.
    - (3) If you find defects that are not correctable, notify your supervisor.

### WARNING

Be sure the bolt is forward before removing back the plate pin assembly. Otherwise, serious injury could result.

- b. Clear a jammed bolt (weapon will not charge).

### DANGER

**Perform these procedures in sequence. Otherwise, the bolt could spring forward suddenly and fire a round, causing injury or death.**

*Note:* Clear all nonessential personnel away from the gun position.

- (1) Place the safety switch on the safe (S) position.
- (2) Press the charger handle locks, and rotate the charger handles down.
- (3) Pull the charger handles to the rear as far as possible. Maintain rearward pressure on them, and have the assistant gunner lift the top cover.

### DANGER

**Do not allow the bolt to slam forward while you are opening the top cover.**

*Note.* If the bolt were to slam forward while you are opening the top cover, the weapon could fire a live round, causing injury or death.

## Performance Steps

- (4) Pull the charger handles to the rear until the bolt clicks (locks); make sure the bolt stays to the rear when you release the charger handles.
  - (5) Insert the cleaning rod section through the slot in the side of the receiver. Prepare to catch the ejected round.
  - (6) Raise the cleaning rod to force the live round down. Catch the live round as it ejects.
  - (7) Remove the ammunition belt from the feeder.
  - (8) Reposition the ammunition belt in the feeder.
  - (9) Place the safety switch on the fire (F) position.
  - (10) Ride the bolt forward by grasping one charging handle and depressing the trigger.
  - (11) Make sure the feed slide assembly is to the left.
  - (12) Make sure the secondary drive lever is engaged with the feed slide pin. If not, engage the forked end with the feed slide pin.
  - (13) Close the top cover gently.
  - (14) Charge the weapon and try to fire.
  - (15) If the bolt jams again, repeat steps (1) through (7). Then place the safety switch on the safe (S) position, and notify your supervisor.
- c. Apply corrective action for uncontrolled fire (runaway gun).

### WARNING

Never try to twist the belt with your hands. This could result in serious injury to personnel.

- (1) Keep the gun pointed on the target.
- (2) Lower one charging handle to make the gun stop firing.
- (3) Place the safety switch on the safe (S) position.
- (4) Clear the weapon and report its condition to your supervisor.

**Evaluation Preparation:** *Setup:* Provide the Soldier with the equipment and personnel listed in the task conditions.

*Brief Soldier:* Tell the Soldier to take corrective action for each situation listed in the standards, one situation at a time. If it is unclear what actions the Soldier is performing, have the Soldier describe the action.

Performance Measures	GO	NO GO
1. Applied immediate action when the weapon failed to fire.	___	___
a. Peacetime and training.		
b. Combat only.		
2. Applied remedial action to correct the malfunction.	___	___
a. Corrected the sluggish operation of an MK19 machine gun.		
b. Cleared a jammed bolt (weapon would not charge).		

Performance Measures	GO	NO GO
c. Applied corrective action for uncontrolled fire (runaway gun).		

**Evaluation Guidance:** Refer to chapter 1, paragraph 1-9e, (1) and (2).

**References**

**Required:**

**Related:** FM 23-27 and TM 9-1010-230-10

**SUBJECT AREA 13: CALIBER .50 M2 MACHINE GUN**

## **071-022-0001**

### **Maintain a Caliber .50 M2 Machine Gun**

**Conditions:** Given a caliber .50 M2 machine gun; M3 tripod; MK64 gun cradle mount; pintle; traversing and elevating (T&E) mechanism; linked caliber .50 ammunition; headspace and timing gauge; cleaner, lubricant, and preservative (CLP); rifle bore cleaner (RBC); lubricating oil semifluid (LSA); carbon removing compound; bore brush; wiping rags; M4 cleaning rod; small arms (2-inch) cleaning swabs; and a wooden block.

**Standards:** Clean and lubricate the caliber .50 M2 machine gun and its components; clean and inspect all parts and ammunition, and turn in unserviceable parts for maintenance; and assemble the gun so that it is operational.

#### **Performance Steps**

- 1.** Clear the caliber .50 M2 machine gun.
  - a.** Unlock the bolt latch release and raise the cover (figure 071-022-0001-1).
  - b.** Pull and lock the bolt to the rear, leaving the retracting slide handle to the rear.
  - c.** Inspect the chamber and T-slot to make sure they hold no rounds.
  - d.** Place a wooden block inside the receiver, between the bolt and the rear of the barrel.
  - e.** Insert the cleaning rod in the muzzle end of the barrel until you can see the rod in the receiver. Remove the cleaning rod.
  - f.** Grasp the retracting slide handle, press the bolt latch release, and ease the bolt forward. Close the cover.

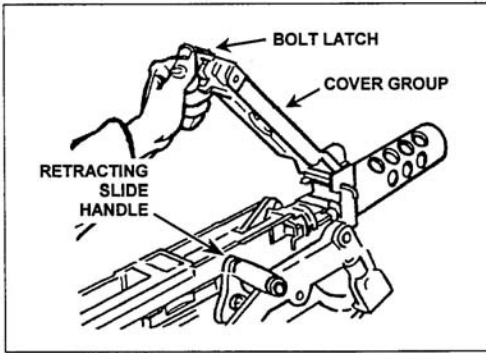

Figure 071-022-0001-1. Raising of the cover

2. Disassemble the machine gun.

a. Remove the barrel assembly.

(1) Raise the cover group (figure 071-022-0001-1).

(2) Grasp the retracting slide handle with the right hand, palm up. Pull the bolt to the rear until the barrel locking spring lug aligns with the  $\frac{3}{8}$ -inch hole in the right side plate of the receiver (figure 071-022-0001-2).

(3) Place the smallest loop of a caliber .50 link between the trunnion block and the barrel extension (figure 071-022-0001-2) to keep the barrel locking spring lug aligned with the  $\frac{3}{8}$ -inch hole.

(4) Unscrew the barrel from the receiver. Be careful not to damage the threads or barrel locking notches.

(5) Remove the caliber .50 link to allow the bolt to go forward slowly. Make sure the bolt group does not slam forward with the barrel removed.

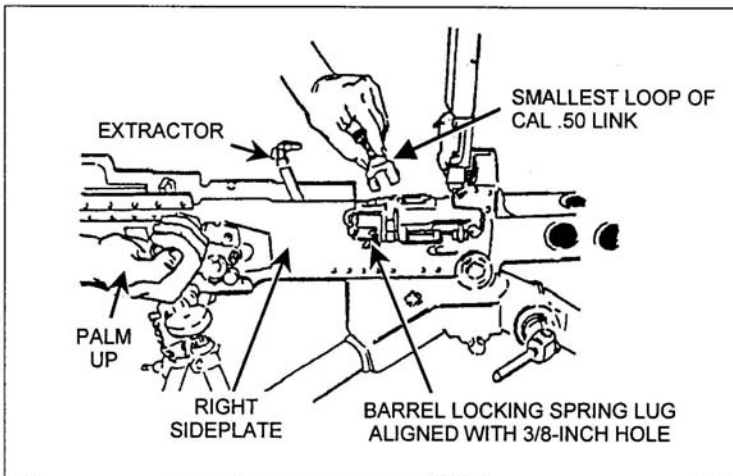

Figure 071-022-0001-2. Align the lug

## Performance Steps

- b. Remove the backplate assembly.

### WARNING

Do not remove the backplate unless the bolt is in the forward position. When removing the backplate, stand to one side of the weapon to avoid possible injury from the driving spring rod.

- (1) Ensure the bolt is forward and the bolt latch release is unlocked (in the single shot mode) (figure 071-022-0001-3).

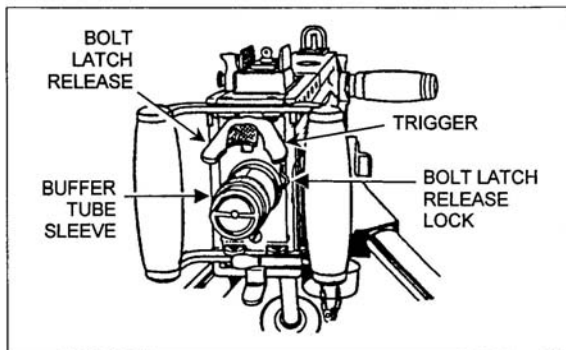

Figure 071-022-0001-3. Release the bolt latch

- (2) Pull the backplate latch lock straight back while lifting up on the backplate latch (figure 071-022-0001-4).

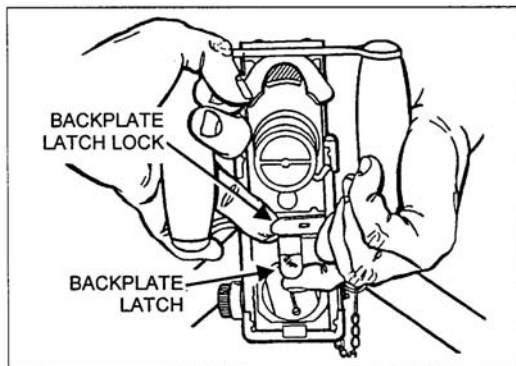

Figure 071-022-0001-4. Removal of the backplate

- (3) Remove the backplate assembly by lifting straight up.
- c. Remove the driving spring rod assembly (figure 071-022-0001-5).

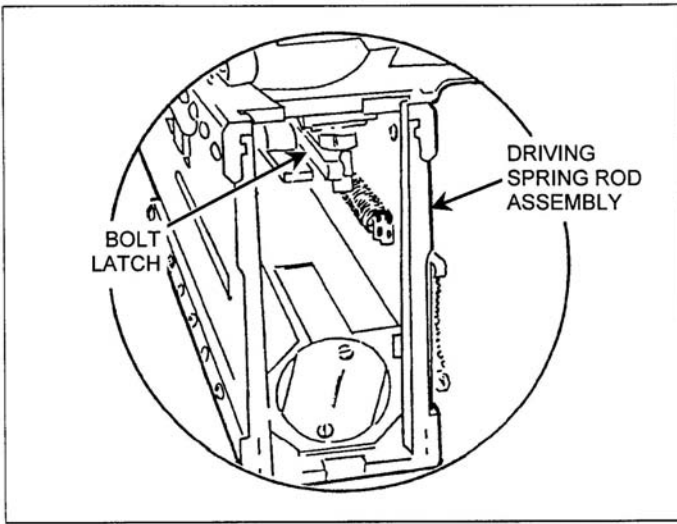

Figure 071-022-0001-5. Removal of the driving spring rod assembly

(1) Push the rear of the driving rod assembly forward and to the left to free it from the side of the receiver.

**WARNING**

Never try to charge the machine gun while the backplate is off and the driving spring rod assembly is in place. If the backplate is off and the driving spring assembly is compressed, the retaining pin on the driving spring can slip from its seat in the side plate, which could cause serious injury to anyone behind the machine gun.

(2) Pull the driving spring rod assembly to the rear and out of the receiver.

d. Remove the bolt assembly.

(1) Retract the bolt assembly far enough to the rear to align the bolt stud with the bolt stud hole in the right side plate of the receiver (figure 071-022-0001-6).



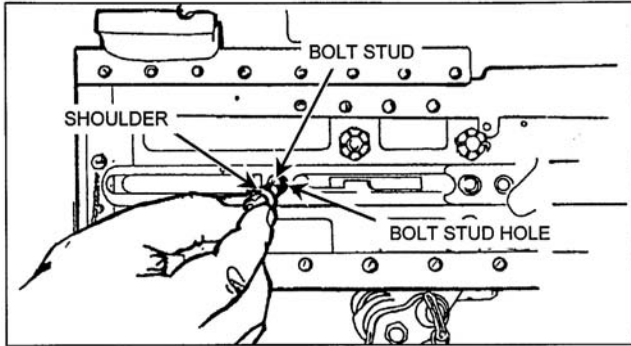

Figure 071-022-0001-6. Removal of the bolt stud

(2) If you accidentally move the bolt all the way to the rear, the bolt latch will engage in the bolt latch notches in the top of the bolt. If this occurs, raise the bolt latch and push the bolt forward to align the bolt stud with the clearance hole (figure 071-022-0001-7).

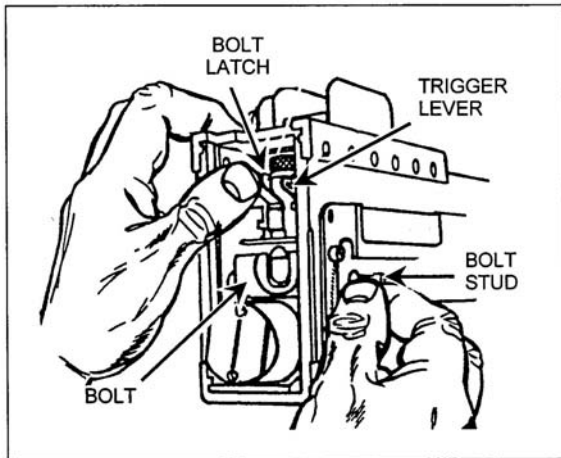

Figure 071-022-0001-7. Unlatch the bolt

(3) Remove the bolt stud.

(4) Remove the bolt assembly by pulling it from the rear of the receiver (figure 071-022-0001-8).

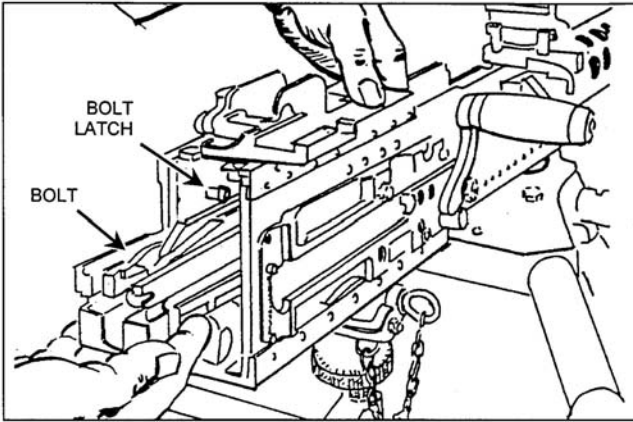

Figure 071-022-0001-8. Removal of the bolt from the receiver

(5) Disassemble the bolt.

(a) Rotate the cartridge extractor upward and remove it from the left side of the bolt (figure 071-022-0001-9).

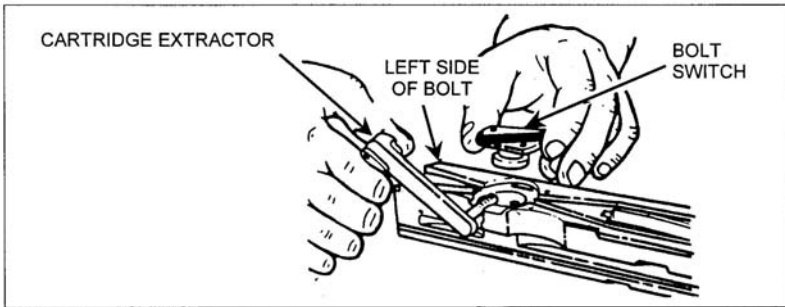

Figure 071-022-0001-9. Removal of the cartridge extractor and bolt

(b) Remove the bolt switch by lifting it straight up.

(c) Place the cocking lever in its rearmost position. Press down on the sear with a swab holder and release the firing pin spring (figure 071-022-0001-10).

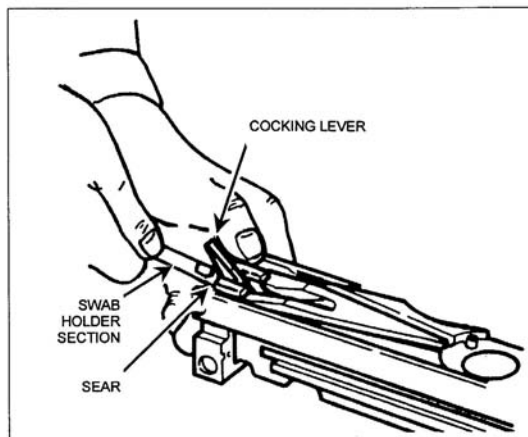

Figure 071-022-0001-10. Release the firing pin spring

(d) Insert a swab holder section in the hole at the rear of the bolt and push out the cocking lever pin and the cocking lever (figure 071-022-0001-11).

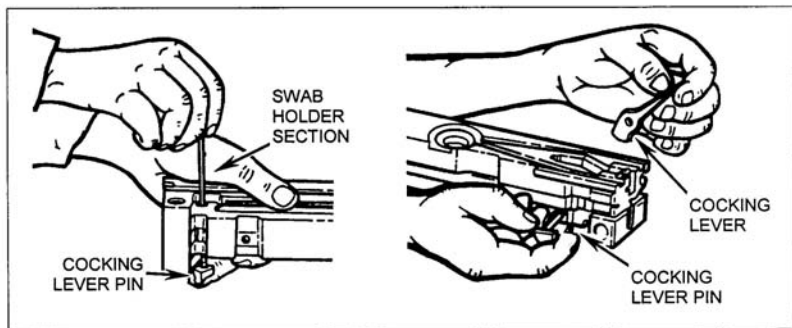

Figure 071-022-0001-11. Removal of the cocking lever pin and cocking lever

(e) Use the thin end of the cocking lever to rotate the accelerator stop lock to the center of the bolt, then pry up the accelerator stop lock and remove it (figure 071-022-0001-12).

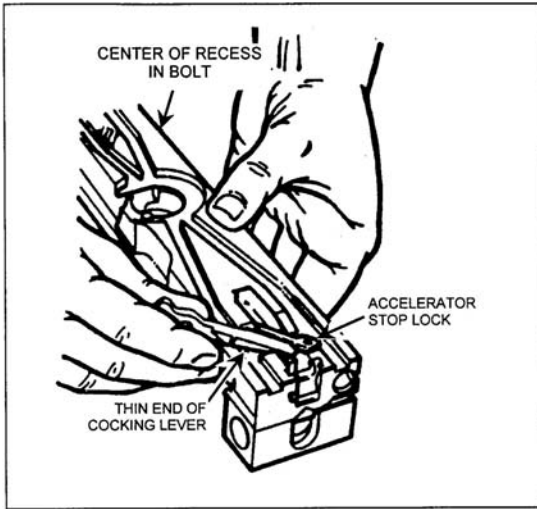

Figure 071-022-0001-12. Removal of the accelerator stop lock

(f) Using the thin end of the cocking lever, press the accelerator stop from the bolt, turn the bolt over, and pry the accelerator stop from bottom of bolt (figure 071-022-0001-13).

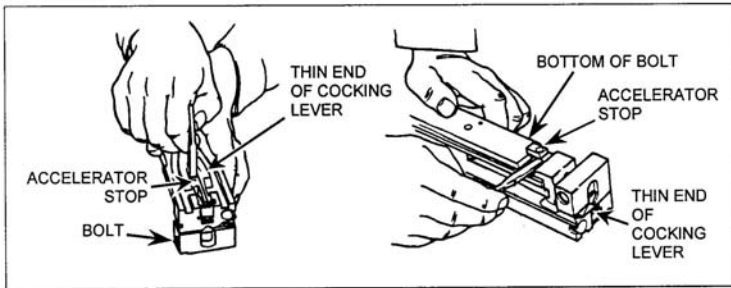

Figure 071-022-0001-13. Removal of the accelerator stop

(g) Depress the sear and remove the sear slide, sear, and sear spring (figure 071-022-0001-14).

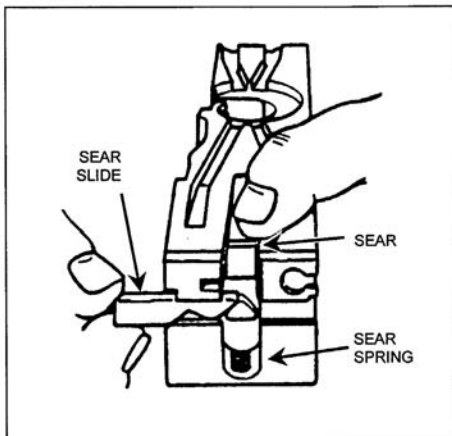

Figure 071-022-0001-14. Removal of the sear slide, sear, and sear spring

- (h) Tip the front end of the bolt upward and remove the firing pin extension assembly (figure 071-022-0001-15).

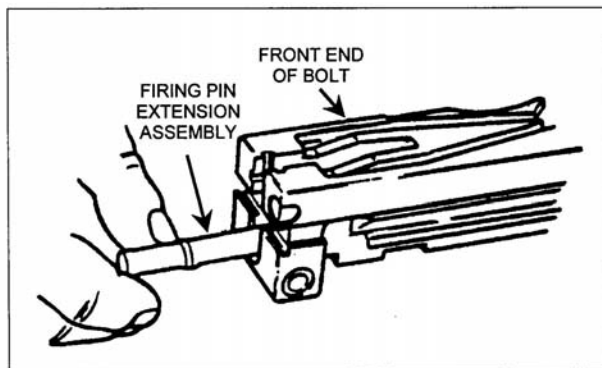
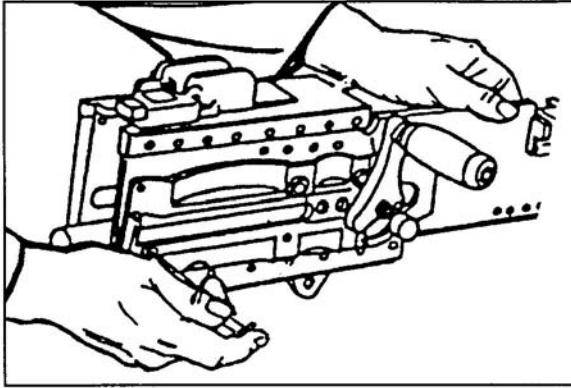

Figure 071-022-0001-15. Removal of the firing pin extension assembly

- (i) Remove the firing pin from the firing pin extension assembly.
- e. Remove the barrel buffer and barrel extension (figure 071-022-0001-16).



**Figure 071-022-0001-16. Removal of the barrel buffer and barrel extension assemblies**

(1) Insert a pointed instrument (you can use the pointed end of the M4 cleaning rod) in the hole at the lower rear corner of the right side plate. Depress the buffer body lock and, at the same time, place one hand inside the receiver and push the barrel extension and buffer assemblies to the rear until the buffer accelerator is near the rear of the receiver body.

**WARNING**

Maintain thumb pressure on the buffer accelerator while removing the barrel buffer and barrel extension assemblies.

(2) Maintain pressure on the buffer accelerator with your thumb and remove the barrel buffer and barrel extension assemblies from the receiver. Separate them by pushing forward on the accelerator tips (figure 071-022-0001-17).

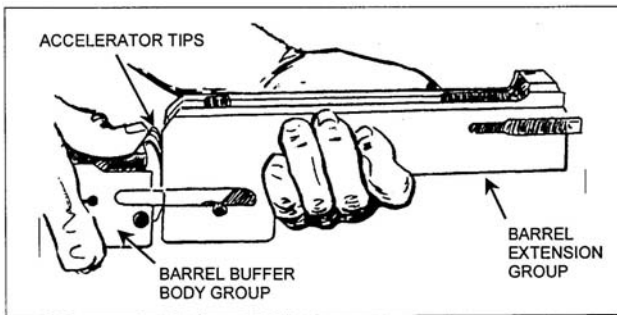

**Figure 071-022-0001-17. Separation of the barrel buffer and barrel extension assemblies**

(3) Disassemble the barrel buffer assembly.

(a) Remove the buffer assembly by pushing it out the rear of the body of the barrel buffer (figure 071-022-0001-18).

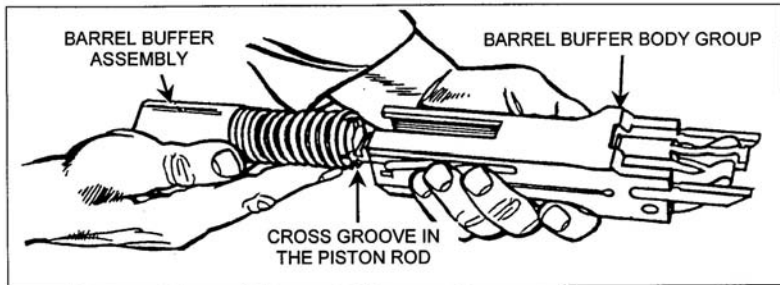

**Figure 071-022-0001-18. Removal of the barrel buffer assembly**

- (b) Using a swab holder, drive the accelerator pin assembly from the barrel buffer body group.
- (c) Remove the buffer accelerator.
- (4) Disassemble barrel extension assembly.
  - (a) Using the pointed end of the M4 cleaning rod, remove breech lock pin assembly (figure 071-022-0001-19).

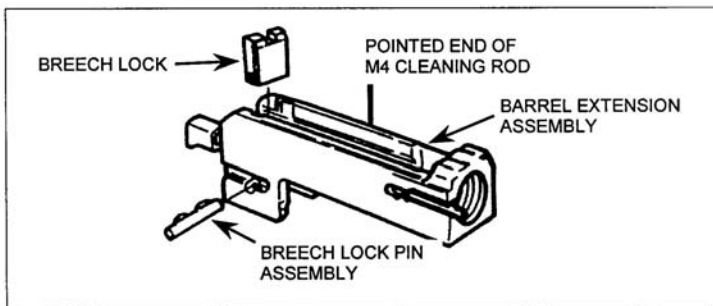

**Figure 071-022-0001-19. Removal of the breech lock pin assembly and breech lock**

- (b) Remove breech lock.
  - f. Disassemble the receiver assembly.
    - (1) Remove the front cartridge stop and rear cartridge stop assembly (figure 071-022-0001-20).

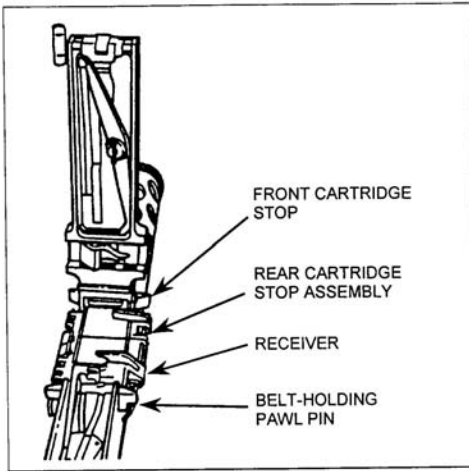

**Figure 071-022-0001-20. Removal of the cartridge stop assemblies**

(2) Press down on belt-holding pawl assembly to prevent loss of springs, and remove the belt-holding pawl pin. Remove belt-holding pawl assembly and springs (figure 071-022-0001-21).

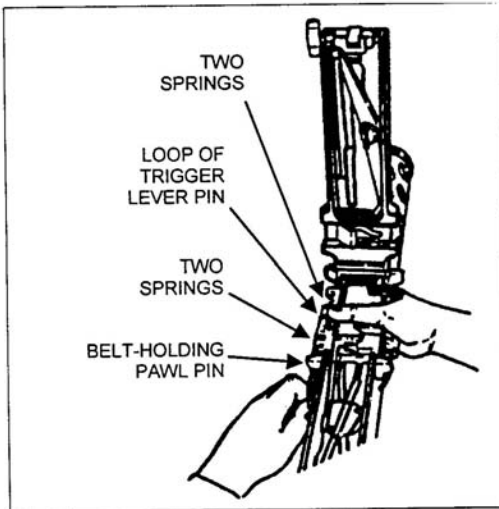

**Figure 071-022-0001-21. Removal of the belt-holding pawl pin, assembly, and springs**

(3) Raise the loop of the trigger lever pin and rotate it into a vertical position. Reach inside the receiver, grasp the trigger lever, and remove the trigger pin assembly and trigger lever (figure 071-022-0001-22).



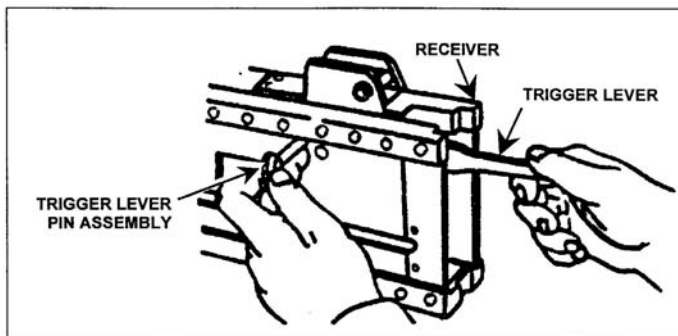

**Figure 071-022-0001-22. Removal of the trigger lever pin assembly and trigger lever**

**3. Clean the caliber .50 machine gun and components.**

**a. Barrel assembly.**

(1) Clean the bore. Screw the bore brush into the cleaning rod, dip the bore brush in RBC, and push the cleaning rod through the chamber end of the barrel. Unscrew the bore brush from the cleaning rod. Repeat the process until clean.

(2) Clean the chamber. Screw the chamber brush into the cleaning rod, dip the chamber brush in RBC, and clean the chamber using a clockwise twisting motion.

(3) Insert a cleaning swab in the cleaning rod and swab out the bore from the chamber end and back. Repeat until a swab comes out clean.

(4) Wipe the outside surfaces of the barrel with carbon removing compound.

(5) Remove all traces of RBC before lubricating.

**Note:** Do not submerge the backplate assembly into any fluid.

**b. Backplate assembly.** Use only clean wiping rags to remove foreign matter from the backplate.

**c. Bolt assembly.** Clean all parts of the bolt assembly with a cleaning swab saturated with carbon removing compound. Clean the face of the bolt with a cleaning swab soaked in RBC.

**d. Clean the barrel buffer assembly, barrel extension assembly, and receiver assembly** with a cleaning swab saturated with carbon removing compound. Wipe all parts dry with clean wiping rags.

**e. Clean the components.**

(1) T&E mechanism. Remove foreign matter with a clean dry wiping rag. Use a small arms cleaning brush to clean numbers on the scale.

(2) Clean the M3 tripod, MK64 gun cradle mount, and pintle with a cleaning swab saturated with carbon removing compound. Wipe all parts dry with the clean wiping rags.

## Performance Steps

- f. Ammunition. Remove foreign matter with a clean, dry wiping rag.
4. Inspect for serviceability.
  - a. Barrel assembly.
    - (1) Check the barrel locking notches for wear.
    - (2) Check the bore for bulges, missing bands, and large pits.
  - b. Backplate assembly.
    - (1) Check the guides for burrs and bends.
    - (2) Check the backplate latch and backplate lock for proper functioning.
    - (3) Make sure the locking pins are in place.
    - (4) Check the trigger and bolt latch release for proper functioning.
    - (5) Make sure the handle grips do not move freely and are not cracked.
  - c. Driving rod assembly.
    - (1) Check for flat spots on the springs.
    - (2) Make sure the springs operate freely and rod and pin are not bent.
  - d. Bolt assembly.
    - (1) Check the movement of the cartridge extractor in the bolt: it should raise and lower without binding. Check the movement of the cartridge ejector.
    - (2) Check the bolt switch, cocking lever pin, cocking lever, accelerator stop lock, accelerator stop, and sear slide for cracks, bends, and burrs.
    - (3) Inspect the sear for cracks and burrs. Inspect the sear notch for wear, chips, and burrs. Inspect the sear spring for breaks and lack of tension.
    - (4) Inspect the firing pin for cracks and chipped or sharp tip. The tip should be smooth and well rounded.
    - (5) Check the firing pin extension for cracks, burrs, and free movement in bolt.
    - (6) Make sure the bolt is free of burrs and cracks and firing pin hole is not visually out of round.
  - e. Barrel buffer assembly.
    - (1) Inspect the buffer body lock for tension, staking, and retention in barrel buffer body.
    - (2) Inspect the buffer accelerator for broken claws or chipped tips.
    - (3) Inspect the accelerator pin assembly for broken or missing spring.
    - (4) Inspect the buffer spring for cracks or breaks.
    - (5) Inspect the breech lock depressors. They must have slight vertical (up and down) movement but should have no lateral (side to side) movement.
  - f. Barrel extension assembly.
    - (1) Make sure the barrel extension assembly is not bent and that the bolt guideways are smooth and free of burrs.

## Performance Steps

- (2) Inspect the threads of the barrel extension assembly for damage.
  - (3) Make sure the barrel locking spring is staked and fully seated in its groove. Also, make sure the locking end of the spring has good tension and the lug is not damaged.
  - (4) Check the breech block for smooth movement in guideways of barrel extension assembly.
- g.** Receiver and cover assembly.
- (1) Inspect the belt-holding pawl brackets for looseness, bends, and cracks.
  - (2) Inspect the side plates for bends that would affect movement of any internal parts.
  - (3) Check for cracks and burrs at the backplate grooves.
  - (4) Check the operation of the rear sight. Make sure the windage and elevation screws function properly, leaf assembly has good spring tension, and sight assembly is secured tightly to receiver.
  - (5) Make sure the bolt stop is present and in good condition.
  - (6) Make sure the trigger lever moves freely.
  - (7) Make sure the trigger lever pin locks in place.
  - (8) Make sure the cotter pin is in place on the extractor switch.
  - (9) Check the retracting slide assembly for visible damage. Check the retracting slide handles for smooth movement. Make sure the cotter pins are present and in good condition, and the safety wire is in place and properly laced.
- h.** Inspect components.
- (1) T&E mechanism.
    - (a) Inspect the handwheels and threads for burrs and rust. Check handwheels for smooth operation.
    - (b) Make sure the traversing slide lock lever has spring action. Make sure the elevating mechanism sleeve fits on the traversing bar and clamps firmly.
    - (c) Check the traversing and elevating scales for legibility.
    - (d) Inspect the quick-release pin and chain for burrs and rust. Check the quick-release pin for presence of spring-loaded balls.
  - (2) M3 tripod.
    - (a) Check for completeness of the tripod. Make sure all nuts and bolts are tightly secured.
    - (b) Check for visible cracks on legs and tripod head.
    - (c) Check for missing, broken, or inoperative sleeve lock latch.
    - (d) Check the pintle lock assembly. Check surfaces of the pintle, bolt, and nut for burrs and rust. Make sure the cotter pin is present and in good condition.
    - (e) Check the locking action of the front leg clamping assembly.

## Performance Steps

(f) Check that the rear legs lock in the open position. Make sure the sleeve latch notch and right leg slide notch engage completely. Make sure the latch spring has good tension.

(g) Check the telescoping, indexing, and locking action of the rear legs and the front leg clamping assembly.

(3) MK64 gun cradle mount.

(a) Check for missing or damaged parts.

(b) Check for rust, cracks, and burrs.

(c) Check the pintle lock assembly. Check surfaces of the pintle, bolt, and nut for burrs and rust. Make sure the cotter pin is present and in good condition.

i. Inspect ammunition. Check for damage or corroded rounds.

5. Lubricate the caliber .50 machine gun.

a. Remove all traces of RBC or carbon removing compound.

### CAUTION

Do not mix lubricants on the same weapon. The weapon must be thoroughly cleaned with dry cleaning solvent during change from one lubricant to another.

b. Lubricate the exterior of the backplate with a light coat of oil. Do not lubricate interior of the backplate.

c. Lubricate all other parts with a light coat of LSA or CLP (at temperatures above 0 degrees Fahrenheit) or LAW (at temperatures below 0 degrees Fahrenheit).

6. Assemble the caliber .50 machine gun.

a. Assemble the trigger lever (figure 071-022-0001-23).

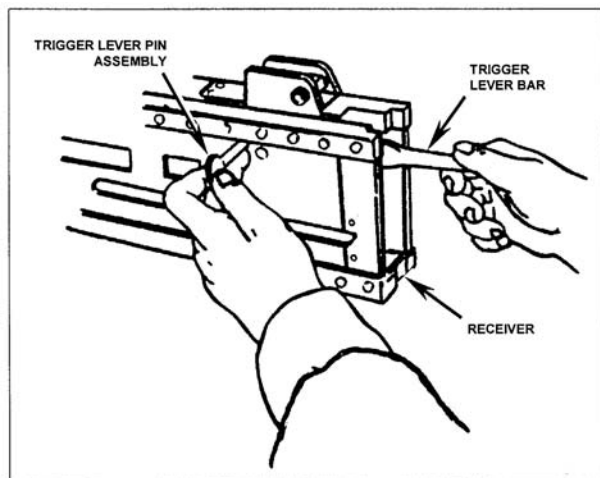

Figure 071-022-0001-23. Assembly of the trigger lever

(1) Place the trigger lever bar in the receiver directly under the timing nut so that the hole in the trigger lever bar is aligned with the mounting hole in the receiver.

(2) Insert the trigger lever pin assembly (loop end vertical) in the assembly hole on the left side of the receiver. Match the key on the trigger lever pin with the keyway in the side plate of the receiver and install the pin completely.

(3) Rotate the trigger pin lever assembly 90 degrees and lock in place. Fold the loop end down.

**b.** Assemble the receiver group.

(1) Determine the direction of feed. (figure 071-022-0001-24 shows left-hand feed.) Place the right-hand rear cartridge stop assembly and front cartridge stop on the belt-holding pawl bracket.

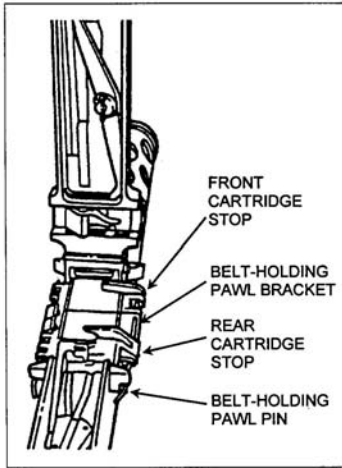

**Figure 071-022-0001-24. Installation of the rear cartridge stop assembly and front cartridge stop**

- (2) Install belt-holding pawl pin with the hooked end to the rear.
- (3) Seat the belt-holding pawl springs in place on the belt-holding pawl bracket.
- (4) Place the belt-holding pawl assembly on the springs. Compress the springs and insert the belt-holding pawl pin (figure 071-022-0001-25).

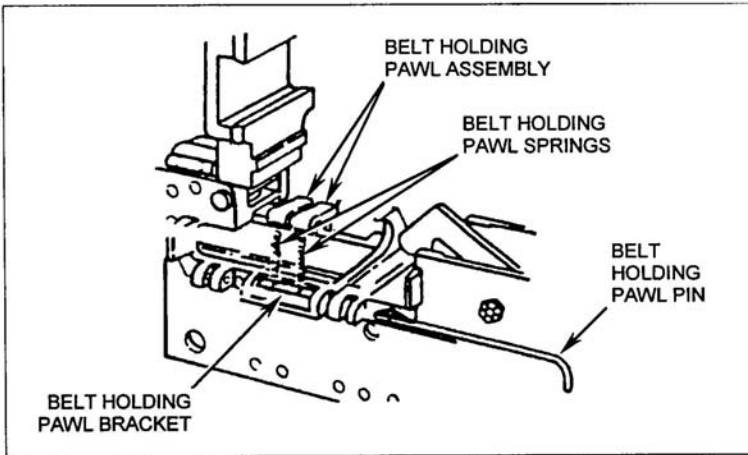

**Figure 071-022-0001-25. Installation of the belt-holding pawl assembly**

- c. Assemble the barrel extension (figure 071-022-0001-26).

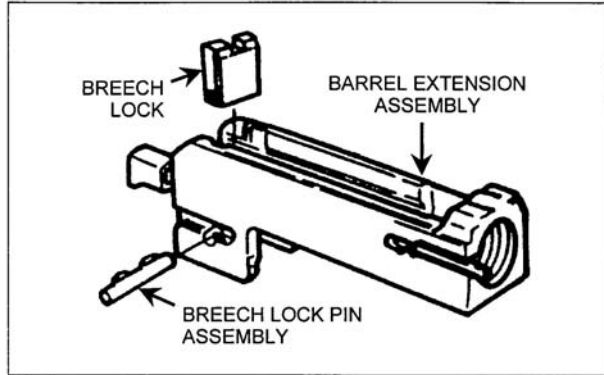

**Figure 071-022-0001-26. Assembly of the barrel extension assembly**

(1) Install the breech block lock with the beveled edge up and to the front of the barrel extension assembly.

(2) Install the breech lock pin assembly in the barrel extension. Make sure both ends of the breech lock pin assembly are flush with the sides of the barrel extension assembly.

**d.** Assemble the barrel buffer assembly.

(1) Place the buffer accelerator (tips up) into the barrel buffer body, align the mounting holes, and install the buffer pin assembly. Ensure that both ends of the barrel buffer pin assembly are flush with the sides of the barrel buffer body (figure 071-022-0001-27).

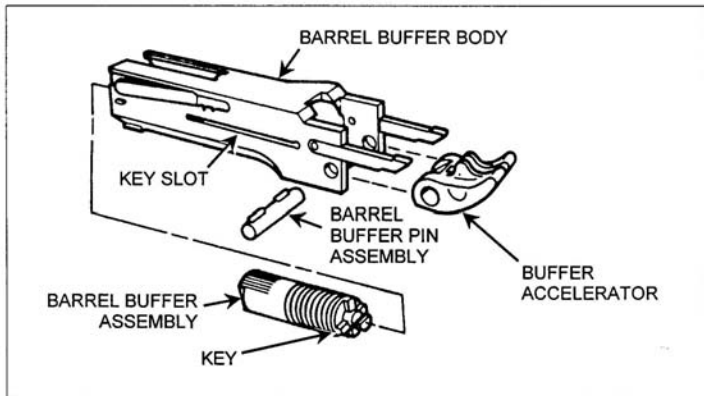
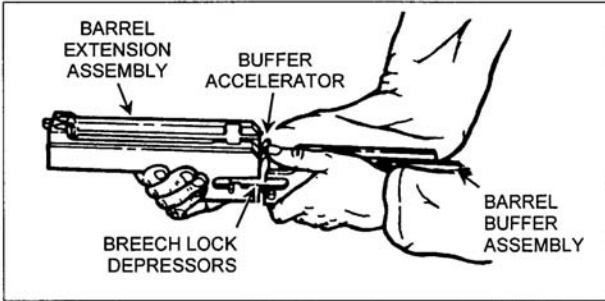

**Figure 071-022-0001-27. Assembly of the barrel buffer assembly**

(2) Align the key on the barrel buffer assembly with the key slot in the barrel buffer body and the slide barrel buffer assembly into the barrel buffer body.

## Performance Steps

(3) Hold the barrel buffer assembly with the buffer accelerator up and engage the notch on the shank of the barrel extension assembly with the cross groove in the piston rod of the barrel assembly (figure 071-022-0001-28).



**Figure 071-022-0001-28. Attachment of the barrel buffer and barrel extension assemblies**

(4) Align the breech lock depressors in the grooves of the barrel extension assembly and push the barrel buffer assembly forward.

(5) Install the barrel buffer assembly and the barrel extension assembly in the receiver (figure 071-022-0001-29).

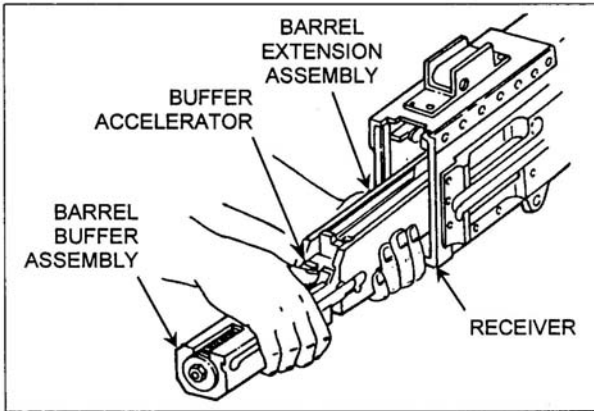
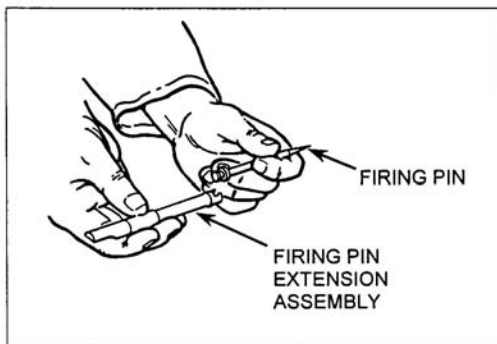

**Figure 071-022-0001-29. Installation of the barrel buffer and barrel extension assemblies**

e. Assemble the bolt assembly.

(1) Attach the firing pin to the firing pin extension assembly (figure 071-022-0001-30).





**Figure 071-022-0001-30. Attachment of the firing pin to the firing pin extension assembly**

- (2) Insert the firing pin extension assembly into the bolt with the notch of the firing pin extension assembly down (figure 071-022-0001-31).

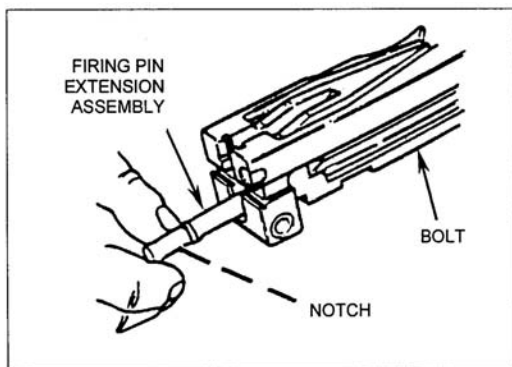

**Figure 071-022-0001-31. Installation of the firing pin extension assembly**

- (3) Slide the firing pin extension assembly forward so that the tip of the firing pin protrudes from the face of the bolt.
- (4) Place the sear spring in the recess on the bolt. Slide the sear down into the vertical grooves at the rear of the bolt with the wedge-shaped lug pointed outward and upward (figure 071-022-0001-32).

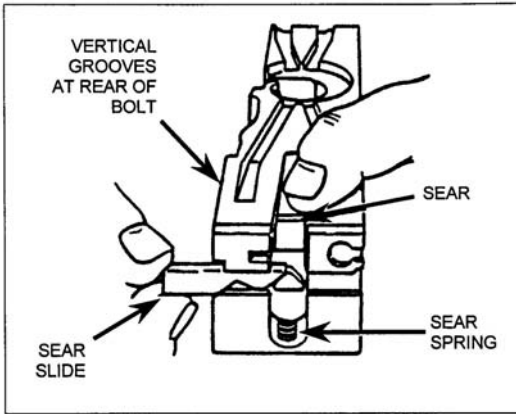

Figure 071-022-0001-32. Installation of the sear side

(5) Compress the sear spring by pressing down on the sear. Install the sear slide from the left side of the bolt in the grooves of the bolt with the "V" notch down.

*Note:* Make sure the pin end of the accelerator is installed behind the firing pin spring, not through a coil.

(6) Insert the pin end of the accelerator stop through the bottom of the bolt (figure 071-022-0001-33).

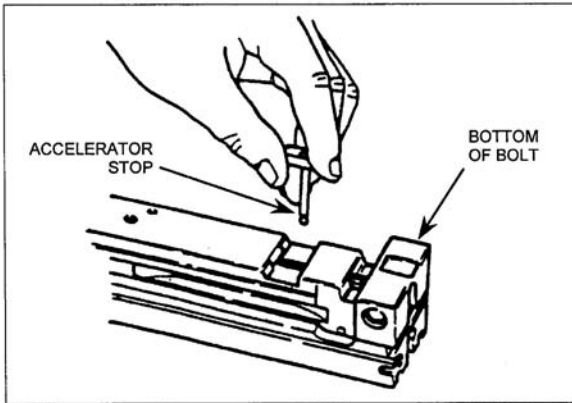

Figure 071-022-0001-33. Attachment of the accelerator stop

*Note:* The base end of the accelerator stop should be installed with the long end forward so the beveled edges match.

(7) Turn over the bolt. Place the forked end of the accelerator stop lock on the notched end of the accelerator stop.

(8) Using the wedge-shaped end of the cocking lever, press down on the flat end of the accelerator stop lock, and move the cocking lever into the groove on the left side of the bolt (figure 071-022-0001-34).

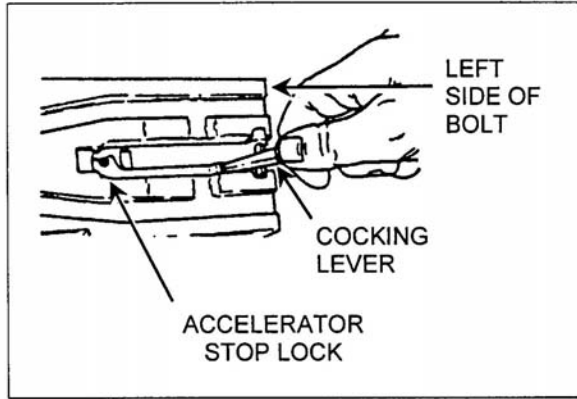

Figure 071-022-0001-34. Attachment of the accelerator stop lock

(9) Insert the cocking lever, with rounded nose on the lower end of the lever to the rear, into the slot in the top of the bolt (figure 071-022-0001-35).

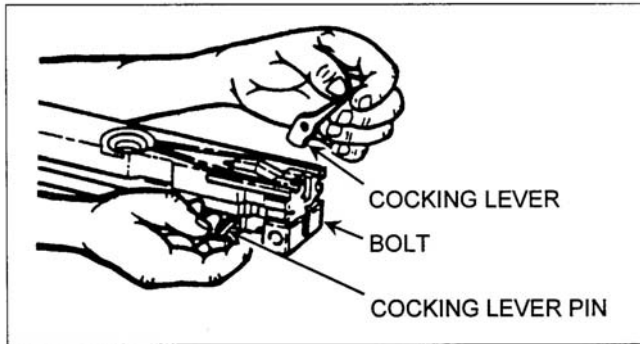

Figure 071-022-0001-35. Attachment of the cocking lever

(10) Align the hole in the cocking lever with the holes in the bolt. Insert the cocking lever pin from the left side.

(11) Push the cocking lever forward to charge the firing pin. Return the cocking lever to the rearward position.

**WARNING**

Do not try to release the firing pin with the cocking lever forward. The cocking lever could spring back forcibly and cause serious injury.

(12) Test the firing pin release. Trip the firing pin by depressing the top of the sear with a section of a swab-holder. If doing so makes a sharp metallic sound, then the firing pin spring is in good condition (figure 071-022-0001-36).

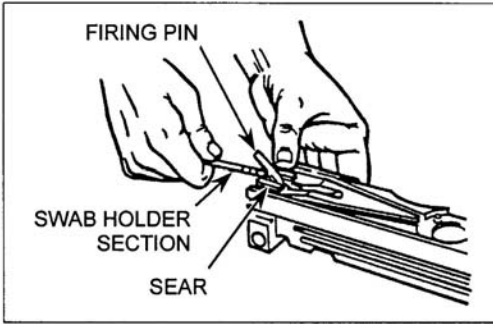

Figure 071-022-0001-36. Testing of the firing pin release

(13) Place the cocking lever in the forward position. Determine the direction of feed before installing the bolt switch.

(14) Place the bolt switch in position so that the feed groove is continuous for the feed direction indicated (figure 071-022-0001-37).

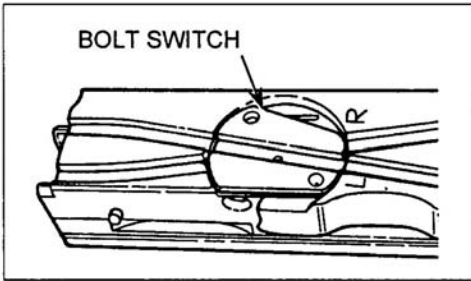

Figure 071-022-0001-37. Setting of the bolt switch

(15) Hold the cartridge extractor in the vertical position and insert the shank end of the cartridge extractor into the left side of the bolt. Make sure the cartridge extractor fits into the bolt as far as possible.

(16) Rotate the cartridge extractor downward to the full horizontal position. Check that the flange on the bottom of the cartridge extractor has engaged the shoulder on the bolt.

(17) Ensure that the cocking lever is forward.

(18) Push the bolt assembly forward into the receiver until the bolt latch engages the notches in the top of the bolt assembly (figure 071-022-0001-38).

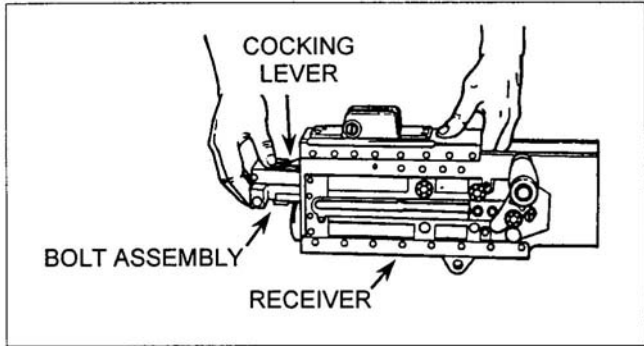

Figure 071-022-0001-38. Installation of the bolt assembly

(19) If you cannot install the bolt this way, remove the barrel extension and buffer assembly from the receiver. Install the bolt assembly into the barrel extension and buffer assembly and then install them in the receiver (figure 071-022-0001-39).

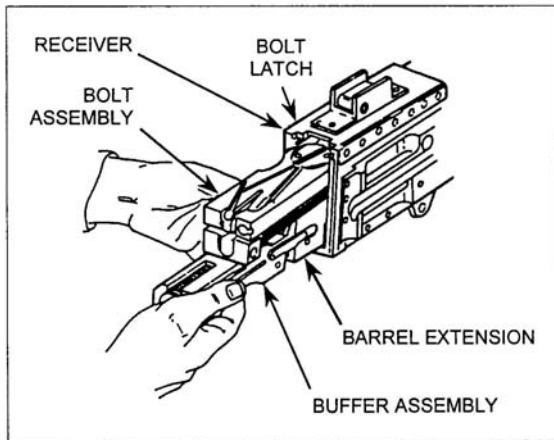

Figure 071-022-0001-39. Installation of the bolt assembly within the barrel extension and buffer assembly

(20) Raise the bolt latch and push the bolt assembly into the receiver.

(21) Align the holes in the bolt assembly with the stud assembly hole in the receiver and install the bolt stud in the hole in the bolt assembly. Place the bolt in the forward position (figure 071-022-0001-40).

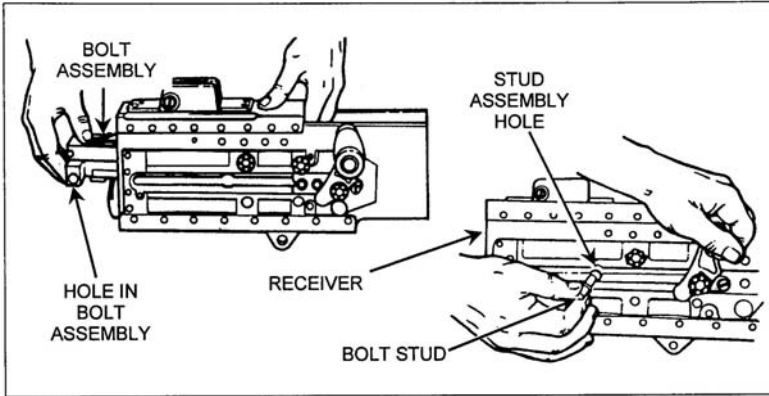

Figure 071-022-0001-40. Installation of the bolt assembly

f. Assemble the driving spring rod assembly (figure 071-022-0001-41). Install the driving spring rod assembly in the upper right corner of the bolt. Push forward and to the right until the driving spring rod assembly engages in the hole in the side plate of the receiver—not in the groove for the backplate.

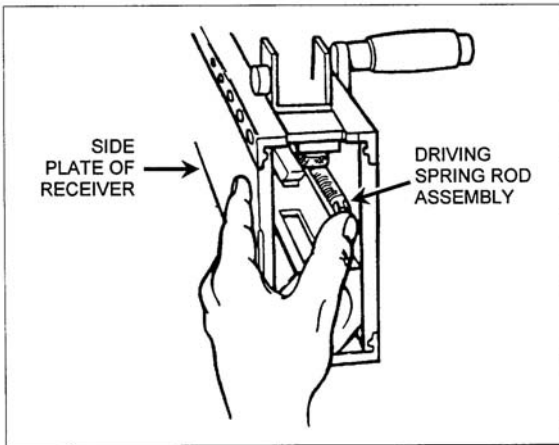
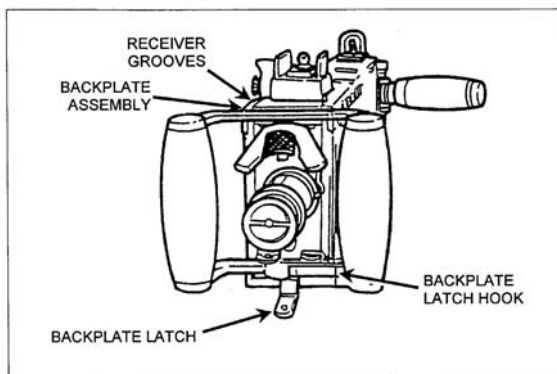

Figure 071-022-0001-41. Installation of the driving spring rod assembly

g. Install the backplate assembly (figure 071-022-0001-42).



**Figure 071-022-0001-42. Installation of the backplate assembly**

(1) Align the backplate assembly with the receiver grooves. Pull the backplate latch lock while lifting up on the backplate latch. Lower the backplate assembly down until engaged in the receiver.

(2) Test for proper locking by pulling up on the backplate assembly.

**h. Assemble the barrel assembly.**

(1) Retract the bolt far enough for the barrel locking spring lug to center in the barrel locking spring hole on the right side of the receiver.

(2) Place the smallest loop of a caliber .50 link between the trunnion block and the barrel extension to keep the barrel locking spring lug aligned with the  $\frac{3}{8}$ -inch hole.

(3) Install and screw the barrel assembly completely into the receiver. Unscrew the barrel assembly two clicks and check the headspace.

7. Perform a function check to make sure the weapon is assembled correctly.

**a. Place the weapon in the single-shot mode.**

(1) Open the cover and pull the retracting slide handle to the rear. The bolt should lock to the rear in the single-shot mode.

(2) Hold the retracting slide handle to the rear; depress the bolt latch release and ease the bolt forward.

(3) Press the trigger; the weapon should fire.

**b. Place the weapon in the automatic-fire mode.**

(1) Pull the retracting slide handle to the rear and hold. The bolt should not lock to the rear in the automatic-fire mode.

(2) Release the pressure on the retracting slide handle and ease the bolt forward.

(3) Press the trigger; the weapon should fire.

---

**Evaluation Preparation:** *Setup:* At the test site, provide the Soldier with equipment listed in the task conditions. Use the performance steps in the training outline to evaluate the Soldier's performance of the task.

*Brief Soldier:* Tell the Soldier to clear, disassemble, clean, inspect, lubricate, assemble, and perform a function check on the weapon.

Performance Measures	GO	NO GO
1. Cleared the weapon.	___	___
2. Disassembled the weapon without damaging any parts.	___	___
3. Cleaned the weapon, components, and ammunition.	___	___
4. Identified any damaged, worn, or malfunctioning parts.	___	___
5. Lubricated the weapon using the correct lubrication technique.	___	___
6. Assembled the weapon in the correct sequence without damaging any parts.	___	___
7. Performed a function check.	___	___

**Evaluation Guidance:** Refer to chapter 1, paragraph 1-9e, (1) and (2).

**References**

**Required:**

**Related:** FM 3-22.65 and TM 9-1005-213-10

## 071-022-0003

### Load a Caliber .50 M2 Machine Gun

**Conditions:** Given a cleared caliber.50 machine gun, mounted on a tripod or cupola, and linked caliber.50 ammunition.

**Standards:** Load the linked ammunition in the feed tray groove so that when the cover is closed, a round remains in the tray groove, and the ammunition feeds correctly.

<b>Performance Steps</b>
--------------------------

1. Check to ensure the weapon is clear.
2. Load the ammunition.
  - a. Ensure the bolt is forward and the cover is closed.
  - b. Insert the double-loop end of the belt in the feed tray until the belt-holding pawl engages the first round.
  - c. With the palm of your hand facing up, pull the retracting slide handle to the rear and release it. (If the bolt latch release is up, return the retracting slide handle to the forward position and then release the bolt.)
  - d. With the palm of your hand facing up, pull the retracting slide handle to the rear a second time and release it. When the bolt goes forward the second time, the gun is loaded.
  - e. To set the gun in automatic mode, lock the bolt-latch release down.



### Performance Steps

f. To set the gun in single-shot mode, keep the bolt-latch release unlocked and in the up position. Release it manually for each round.

**Evaluation Preparation:** *Setup:* Provide the Soldier with equipment and materials listed in the conditions. Evaluate this task in a classroom or training area using dummy linked caliber .50 ammunition.

*Brief Soldier:* Tell the Soldier to load the weapon using the belt of ammunition.

Performance Measures	GO	NO GO
1. Ensured the bolt was forward and the cover was closed.	_____	_____
2. Inserted the double-loop end of the belt into the feed tray until the belt-holding pawl held the first round.	_____	_____
3. Pulled the retracting slide handle to the rear and released it. If the bolt-latch release was up, returned the retracting slide handle to the forward position, and then released the bolt.	_____	_____
4. Pulled the retracting slide handle to the rear a second time and released it. When the bolt went forward the second time, the gun was loaded.	_____	_____

**Evaluation Guidance** Refer to chapter 1, paragraph 1-9e, (1) and (2).

### References

#### Required:

**Related:** FM 3-22.65 and TM 9-1005-213-10

## 071-022-0004

### Unload a Caliber .50 M2 Machine Gun

**Conditions:** Given a caliber .50 M2 machine gun mounted on a tripod or cupola, loaded with linked caliber .50 ammunition.

**Standards:** Remove all ammunition and links from the machine gun. Clear the weapon, ensure the chamber is empty, and the weapon is in the single-shot mode.

### Performance Steps

1. Unload a cold weapon (fewer than 200 rounds have been fired from the weapon).
  - a. Keep the gun oriented on the target area.
  - b. Place the gun in the single-shot mode.
  - c. Raise the cover.
  - d. Lift the extractor away from the ammunition belt.
  - e. Remove the ammunition belt from the feedway.

## Performance Steps

- f. With your palm up, pull the retracting slide handle to the rear to lock the bolt to the rear.
  - g. Inspect the chamber and T-slot area to ensure they contain no ammunition, links, or brass.
  - h. Hold the charging handle, release the bolt, and allow the bolt to move slowly forward.
  - i. Close the cover.
2. Unload a hot weapon (more than 200 rounds have been fired from the weapon).
  - a. Keep the gun oriented on the target area.
  - b. Place the gun in the single-shot mode.
  - c. Fire the round that is in the chamber.
  - d. Raise the cover and remove the ammunition belt from the feedway.
  - e. Press down on the bolt-latch release to allow the bolt to go forward and chamber the round in the T-slot.
  - f. Close the cover and fire the round.
  - g. Open the cover and inspect the chamber and T-slot area to ensure they contain no ammunition, links, or brass.
  - h. Hold the charging handle, release the bolt, and allow the bolt to move slowly forward.
  - i. Close the cover.

**Evaluation Preparation:** *Setup:* Provide all equipment and materials listed in the task conditions statement. You can evaluate this task in a classroom or training area using dummy linked caliber .50 ammunition.

*Brief Soldier:* Tell the Soldier to unload and clear the caliber .50 M2 machine gun.

Performance Measures	GO	NO GO
1. Placed the gun in the single-shot mode.	___	___
2. Raised the cover.	___	___
3. Removed the ammunition belt from the feed tray.	___	___
4. Closed the cover.	___	___
5. Pulled the bolt to the rear and locked it.	___	___
6. Raised the cover and inspected it to make sure there were no rounds in the chamber.	___	___

Performance Measures	GO	NO GO
7. Held the charging handle and the released the bolt which allowed it to move slowly forward.	_____	_____
8. Pressed the trigger.	_____	_____

**Evaluation Guidance:** Refer to chapter 1, paragraph 1-9e, (1) and (2).

### References

#### Required:

**Related:** FM 3-22.65 and TM 9-1005-213-10

## 071-022-0005

### Correct Malfunctions of a Caliber .50 M2 Machine Gun

**Conditions:** Given a loaded caliber .50 M2 machine gun mounted on a tripod or cupola; a sector of fire; an assistant gunner; linked caliber .50 ammunition; a ruptured cartridge extractor; a cleaning rod; cleaner, lubricant, preservative (CLP); lubricating oil, Arctic weather (LAW); cleaning swabs; and a headspace and timing gauge. The caliber .50 machine gun has been firing and one of the following situations has developed: the weapon fails to fire; the weapon continues to fire after the trigger is released (uncontrolled fire); or the weapon fires sluggishly.

**Standards:** Within 5 seconds after a caliber .50 machine gun fails to fire, take immediate action to return the weapon to service. If immediate action is not successful, perform remedial action and identify the cause of the malfunction. Take immediate action to secure a runaway caliber .50 machine gun, and then take remedial action to eliminate the malfunction. Take corrective action for a caliber .50 machine gun that fires sluggishly.

#### Performance Steps

1. Take immediate action to correct a failure to fire.
  - a. On a cool weapon (one that has fired fewer than 150 rounds in 2 minutes—
    - (1) Hold the weapon on target.
    - (2) Wait 5 seconds in case the weapon has a hangfire.
    - (3) Pull the bolt to the rear. Return the retracting slide handle to its forward position. If the bolt locks to the rear, depress the bolt latch to return the bolt to the forward position.
    - (4) Try to fire. If the weapon fires, you have corrected the stoppage.
    - (5) If the weapon fails to fire, wait 5 seconds, pull the bolt to the rear, and lock it in the rearward position (engage with the bolt latch). Return the retracting slide handle to its forward position.
    - (6) Proceed to step 2, remedial action.
  - b. On a hot weapon (one that has fired 150 or more rounds in 2 minutes—
    - (1) Hold the weapon on target.
    - (2) Wait 5 seconds in case there is a hangfire.

## Performance Steps

(3) Within the next 5 seconds, pull the bolt to the rear, return the retracting slide handle to its forward position, and try to fire. If the weapon fires, you have corrected the stoppage.

(4) If the weapon fails to fire or if you were unable to retract the bolt during step 1b(3), keep the cover closed and wait 15 minutes to allow the weapon to cool.

(5) Go to step 2.

### **DANGER**

**Never open the cover assembly on a hot weapon. The weapon could cook off, which could damage the weapon, and more importantly, could kill or injure personnel.**

**Apply immediate action to a hot weapon within 10 seconds. If you are unable to either fire or remove the round within 10 seconds, then you must wait another 15 minutes before you can do anything else to the weapon.**

2. Take remedial action.

a. Open the cover assembly and check for faulty ammunition or an obstruction in the barrel assembly and chamber.

b. If a cartridge is in the T-slot of the bolt and does not fall out, hold the bolt to the rear, raise the extractor, and use a screwdriver to push the cartridge out of the bottom of the receiver.

c. If a ruptured (separated) cartridge case is in the T-slot, remove it with a cleaning rod or ruptured cartridge extractor.

(1) When using the ruptured cartridge extractor, raise the cover and pull and lock the bolt to the rear. Place the extractor in the T-slot the same way you would a cartridge. Use the gun's extractor assembly ejector to hold the extractor in line with the bore. When the extractor is aligned with the bore, let the bolt go forward into the ruptured case. The shoulders will spring out in front of the case. Pull the bolt to the rear and remove the ruptured case and extractor.

(2) When using a cleaning rod, raise the cover and pull and lock the bolt to the rear. Insert the cleaning rod in the front end of the barrel. Gently push the ruptured cartridge from the chamber.

d. Reload and try to fire the weapon. If the weapon does not fire, continue remedial action.

e. Disassemble the weapon and inspect for dirt, obstructions, and defective parts.

f. Clean the weapon, remove obstructions, and replace defective parts. Lubricate and assemble the weapon.

g. Set or adjust the headspace and timing.

h. Replace faulty ammunition.

## Performance Steps

- i. If the weapon still fails to fire, notify your supervisor.
  3. Take immediate action to stop uncontrolled automatic fire (runaway gun).
    - a. Perform one of three actions:
      - (1) Hold the weapon on target until it stops firing.
      - (2) Have the assistant gunner twist the belt, which will cause the gun to jam.
      - (3) Allow the weapon to fire the remaining ammunition.
    - b. If you have fired all of your ammunition, check to ensure that the weapon is clear and then go to step 3c. If you have not fired all of your ammunition and the weapon is hot (has fired more than 150 rounds in less than 2 minutes), keep the cover assembly closed, wait 15 minutes, then proceed to step 3c.
    - c. Disassemble the weapon and inspect for defective parts.
    - d. Clean the weapon, remove obstructions, replace defective parts, lubricate, and assemble the weapon.
    - e. Check the headspace and timing and adjust, if necessary.
    - f. If the weapon still fails to fire properly, notify your supervisor.
  4. Correct a sluggishly operating weapon.
    - a. Clear the weapon.
    - b. Disassemble, clean, and lubricate the weapon.
    - c. Assemble the weapon.
    - d. Set headspace and timing.

**Evaluation Preparation:** *Setup:* Evaluate this task at a test site rather than on a live-fire range. Provide the materials and equipment listed in the task conditions statement. Give the Soldier caliber .50 linked dummy rounds instead of live rounds. Insert an expended round in the belt to cause a stoppage.

*Brief Soldier:* Tell the Soldier to assume a firing position behind the caliber .50 machine gun and apply any required immediate action. Tell the Soldier the test does not require him/her to perform remedial action. Ask the Soldier to describe the actions to perform remedial action on cold and hot weapons, a sluggishly operating weapon, and a runaway weapon.

Performance Measures	GO	NO GO
1. Took immediate action for a failure to fire within 10 seconds.	_____	_____
a. Held the weapon on target.		
b. Waited 5 seconds in case the weapon had a hangfire.		

Performance Measures	GO	NO GO
<p>c. Within the next 5 seconds, pulled the bolt to the rear, returned the retracting slide handle to its forward position, and tried to fire.</p>		
<p>d. If the weapon still failed to fire, waited 5 seconds, and took appropriate remedial action.</p>		
<p>2. Took remedial action on a cooled weapon.</p>	_____	_____
<p>a. Opened the cover assembly.</p>		
<p>b. Removed the ammunition belt.</p>		
<p>c. Removed the ruptured cartridge and all obstructions from the T-slot, barrel assembly, and chamber.</p>		
<p>d. Reloaded and fired the weapon.</p>		
<p>e. If the weapon still did not fire, disassembled it; inspected it for dirt, obstructions, and defective parts.</p>		
<p>f. Cleaned the weapon, removed obstructions, replaced defective parts, lubricated it, assembled it, and set the headspace and timing.</p>		
<p>g. Replaced faulty ammunition.</p>		
<p>h. Notified the supervisor, if the weapon still failed to fire.</p>		
<p>3. Took remedial action on a hot weapon.</p>	_____	_____
<p>a. Kept the cover closed and waited 15 minutes to allow the weapon to cool.</p>		
<p>b. Performed the same procedures as for cooled weapon after the waiting period.</p>		
<p>4. Took action to stop uncontrolled automatic fire (runaway gun).</p>	_____	_____
<p>a. Performed one of three actions:</p>		
<p>(1) Held the weapon on the target until it stopped firing.</p>		
<p>(2) Had the assistant gunner twist the belt, which caused the gun to jam.</p>		
<p>(3) Fired the remaining ammunition.</p>		
<p>b. Took the appropriate remedial action based on whether the weapon was hot or cold.</p>		
<p>5. Corrected a sluggishly operating weapon.</p>	_____	_____

Performance Measures	GO	NO GO
a. Cleared the weapon.		
b. Disassembled, cleaned, and lubricated the weapon.		
c. Assembled the weapon.		
d. Set headspace and timing.		

**Evaluation Guidance:** Refer to chapter 1, paragraph 1-9e, (1) and (2).

**References**

**Required:**

**Related:** FM 3-22.65 and TM 9-1005-213-10

## 071-313-3454

### Engage Targets with a Caliber .50 M2 Machine Gun

**Conditions:** Given a zeroed caliber .50 M2 machine gun (tripod or cupola mounted), linked caliber .50 ammunition, and a sector of fire with engageable targets.

**Standards:** Fire the caliber .50 M2 machine gun to engage targets in your assigned sector of fire. Apply the correct target-engagement techniques so that you cover the entire target with fire.

#### Performance Steps

1. Assume a suitable firing position that allows you to observe and engage targets, but reduces your exposure to enemy fire.
  - a. Prone position (figure 071-313-3454-1).



Figure 071-313-3454-1. Prone position (tripod mount)

- b. Sitting position (figure 071-313-3454-2).

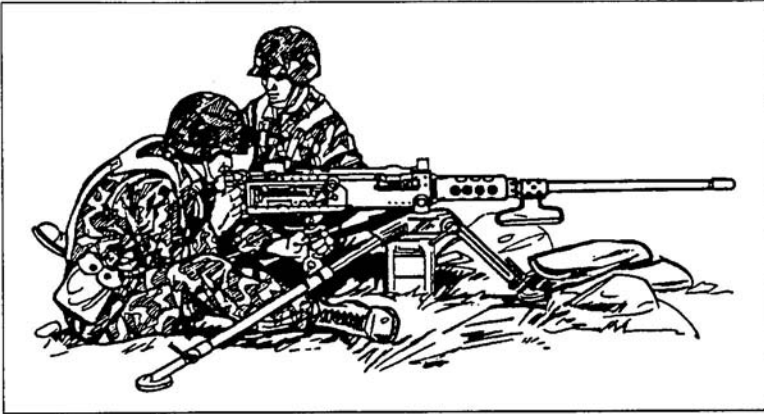

Figure 071-313-3454-2. Sitting position (tripod mount)

- c. Standing position (figure 071-313-3454-3).



Figure 071-313-3454-3. Standing position (tripod mount)

- d. Standing position for cupola-mounted gun (figure 071-313-3454-4).

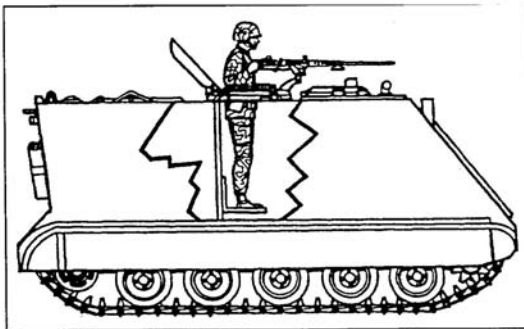

Figure 071-313-3454-4. Standing position (cupola mount)



## Performance Steps

- e. Standing position for high mobility, multipurpose wheeled vehicle (HMMWV)-mounted gun (figure 071-313-3454-5).

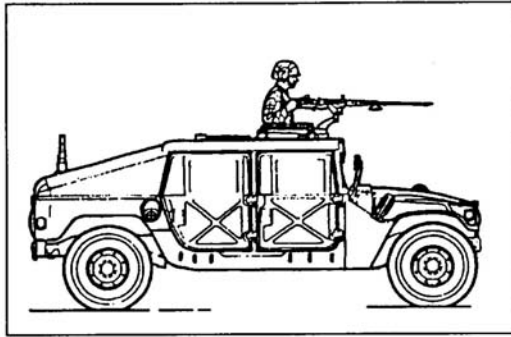

Figure 071-313-3454-5. Standing position (HMMWV mount)

2. Obtain the correct sight picture.
  - a. Sight alignment. Center the front sight post in the peep sight (figure 071-313-3454-6).

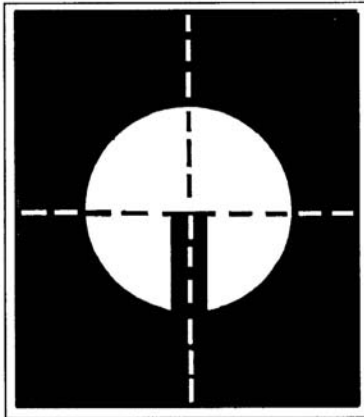

Figure 071-313-3454-6. Correct sight alignment

- b. Sight picture. Place the top center of the front sight blade at the bottom center of the intended target (figure 071-313-3454-7).
-

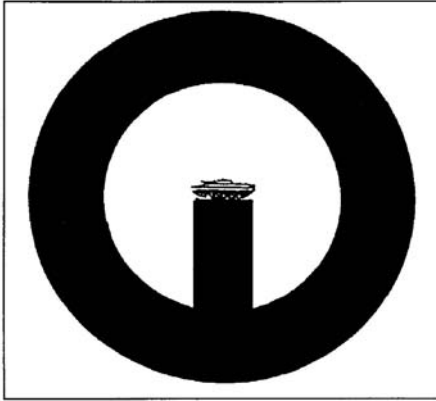

Figure 071-313-3454-7. Correct sight picture

3. Apply the correct engagement technique based on the target type (figure 071-313-3454-8).

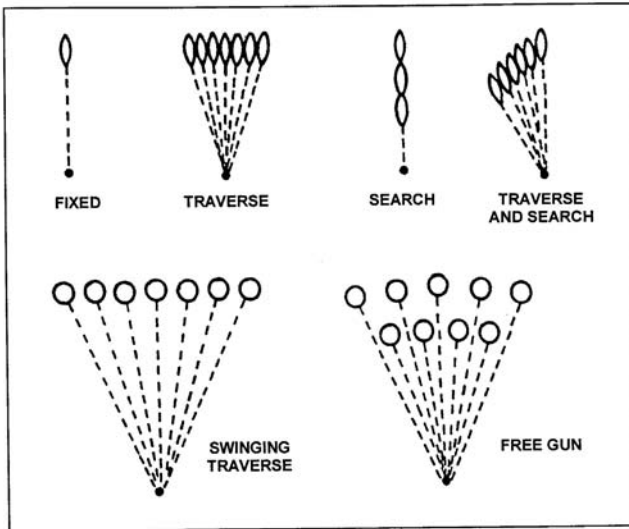

Figure 071-313-3454-8. Techniques of fire with respect to the gun

- a. Use the correct gun manipulation technique.

(1) Fixed fire. Refers to fire delivered against a point target. Only one aiming point is necessary, with little or no manipulation of the gun.

(2) Traversing fire. Refers to fire distributed against a wide target, requiring successive changes in the gun direction. To distribute fire laterally, use the traversing and elevation (T&E) mechanism to traverse the gun left or right.

## Performance Steps

(3) Searching fire. Refers to fire delivered against a deep target or a linear target with depth by successively changing elevation. To distribute fire in depth, use the T&E mechanism to move the muzzle of the weapon up or down.

(4) Traversing and searching fire. Refers to fire delivered in width and depth by successive changes in direction and elevation. Use this type of fire against a target where the long axis is oblique to the direction of fire.

(5) Swinging traverse. Refers to fire delivered against targets that require major changes in direction but with little or no change in elevation. Loosen the traversing slide lock enough to swing the gun laterally.

(6) Free gun. Refers to fire delivered against moving targets that must be rapidly engaged with fast changes in direction and elevation. To fire free gun, remove the T&E mechanism.

### b. Correctly apply fire to engage specific targets.

(1) Point target. Engage point targets with fixed fire using a single aiming point (figure 071-313-3454-9).

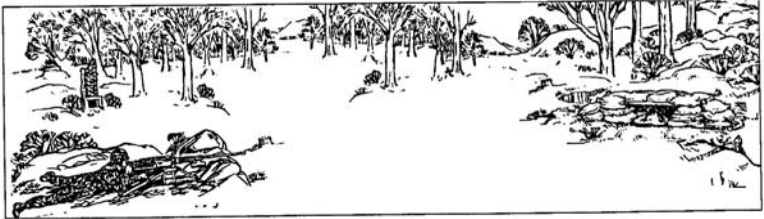

Figure 071-313-3454-9. Point target

(2) Linear target. Initially aim at the midpoint of the target. Traverse fire to one flank and then to the other to cover the entire target (figure 071-313-3454-10).

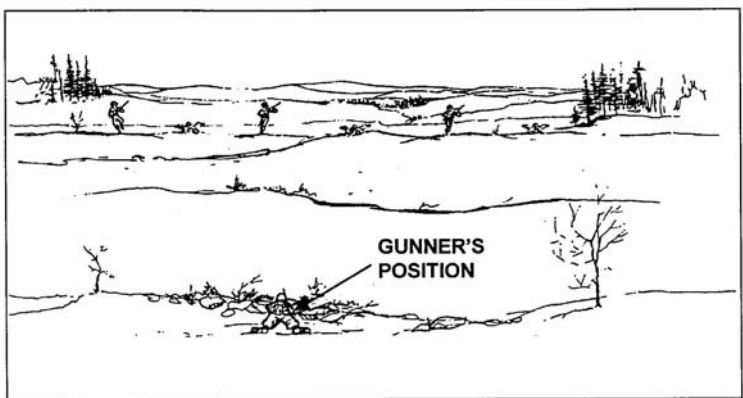

Figure 071-313-3454-10. Linear target and one gun

(3) Linear target with depth. Initially aim at the midpoint of the target, unless another portion of the target is more critical or presents a greater threat. Traverse and search to the flank closest to your position, then back to the other flank, so that you cover the entire target (figure 071-313-3454-11).



Figure 071-313-3454-11. Linear target with depth

(4) Deep target. Initially aim at the midpoint of the target, unless another portion of the target is more critical or presents a greater threat. Search down to the near end, then search up to the far end (figure 071-313-3454-12).

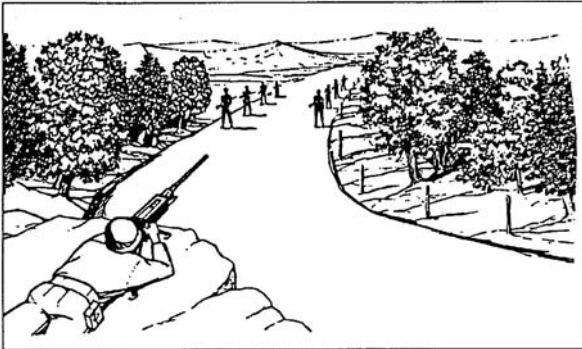

Figure 071-313-3454-12. Deep target

(5) Area target. Initially aim at the midpoint of the target area. Traverse and search to either flank, then traverse and search to the opposite flank (figure 071-313-3454-13).

---

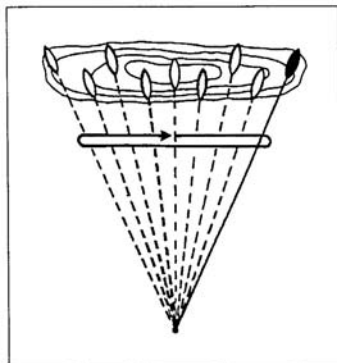

Figure 071-313-3454-13. Area targets

4. Observe fire and adjust the aiming point to place effective fire on the target.
  - a. Observation of fire. Observe bursts of fire by noting tracers in flight or the strike of the rounds in the target area.
  - b. Adjusted aiming point. Adjust fire quickly without adjusting the sight. If the initial burst misses the target, rapidly select a new aiming point the same distance from the center of impact of the initial burst but in the opposite direction. Fire a second burst (figure 071-313-3454-14).

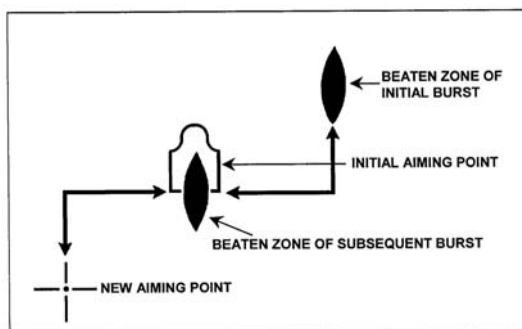

Figure 071-313-3454-14. Adjusted aiming point

5. Fire on the targets until they are all destroyed, or until you receive an order to cease fire.

**Evaluation Preparation:** *Setup:* Evaluate this task on a 10-meter live-fire range equipped with basic machine gun target posters (FSN 6920-078-5128). Provide the Soldier with a caliber .50 M2 machine gun (tripod mounted) with 236 rounds of linked .50 caliber ammunition (117 rounds for practice and 119 rounds for qualification). Conduct 10-meter firing according to table I, appendix C, FM 3-22-65.

*Brief Soldier:* Tell the Soldier to fire table I according to appendix C, FM 3-22.65 (brief the conditions, standards, and ammunition). Tell the Soldier that when you instruct him/her to fire, you will evaluate his/her ability to apply correct target-engagement techniques and to place effective fire on targets.

Performance Measures	GO	NO GO
1. Assumed a suitable firing position.	___	___
2. Obtained the correct sight picture.	___	___
3. Applied the correct engagement technique based on the target type.	___	___
4. Observed fire and adjusted the aiming point to place effective fire on the target (scored at least 84 points).	___	___
5. Fired on the targets until they were all destroyed or until you received an order to cease fire.	___	___

**Evaluation Guidance:** Refer to chapter 1, paragraph 1-9e, (1) and (2).

**References**

**Required:**

**Related:** FM 3-22.65 and TM 9-1005-213-10

**SUBJECT AREA 14: M136 LAUNCHER**

**071-054-0001**

**Prepare an M136 Launcher for Firing**

**Conditions:** Given an M136 launcher (AT4) and a requirement to prepare it for firing.

**Standards:** Perform prefire checks on the M136 AT4 and prepare the round for firing.

**Performance Steps**

*Note:* Because the M136 launcher is issued as a round of ammunition rather than as a weapon, the launcher is completely used; therefore, inspection is limited to visual examination of the external components.

1. Perform the prefire checks. The overall condition of the launcher should be inspected before it is used (figure 071-054-0001-1). The firer should ensure that—
  - a. The transport safety pin is in place and fully seated and the lanyard is attached.
  - b. The cocking lever is in the SAFE position and is folded down.
  - c. The fire-through muzzle cover is intact. If the seal is torn, it should be removed to ensure that no foreign objects have gotten into the launcher.

## Performance Steps

- d. The launcher's color-coded band is the correct color: black for high-explosive antitank; gold for target-practice tracers; and blue for field-handling trainers.
- e. The sights function properly. Open the sight covers to ensure the sights pop up and are not damaged.
- f. The red safety catch does not move when depressed.
- g. The rear seal is not damaged.
- h. The shoulder stop is not broken or damaged and it unsnaps and folds down.
- i. The carrying sling is not frayed and is attached to the launcher.
- j. The launcher body has no cracks, dents, or bulges.

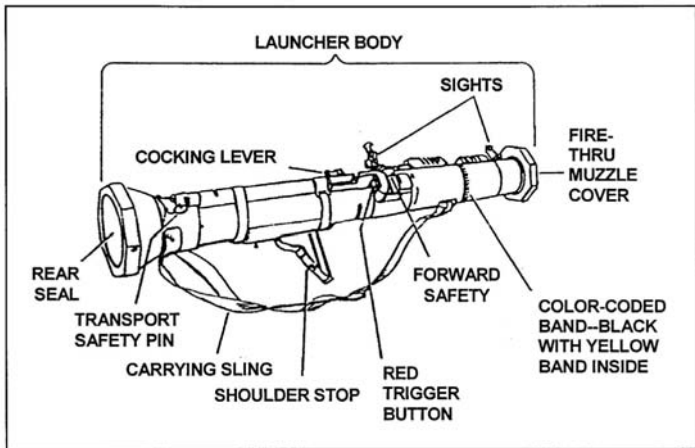

Figure 071-054-0001-1. Parts of the M136 launcher to be inspected

- 2. Prepare the launcher for firing. Preparation procedures are as follows:
  - a. Remove the launcher from the carrying position and cradle it with the left arm (figure 071-054-0001-2).

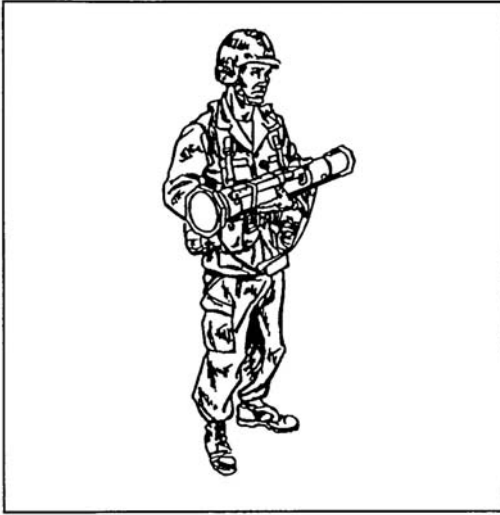

Figure 071-054-0001-2. Cradle position

- b. While cradling the launcher, pull the transport safety pin with the right hand and release it (figure 071-054-0001-3).

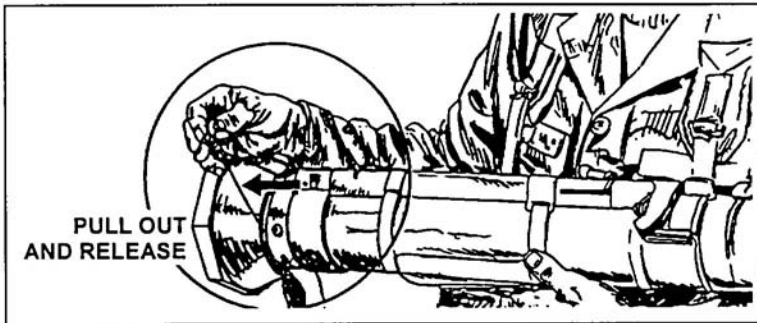

Figure 071-054-0001-3. Removing the transport safety pin

*Note:* Ensure the transport safety pin is attached to the launcher by its lanyard. If the launcher has no lanyard, place the transport safety pin in your pocket. If the launcher remains unfired, reinsert the transport safety pin.

**WARNING**

- Make sure personnel wear earplugs.
- Point the weapon toward the target.
- Clear the backblast area.

- c. Unsnap and unfold the shoulder stop (figure 071-054-0001-4).



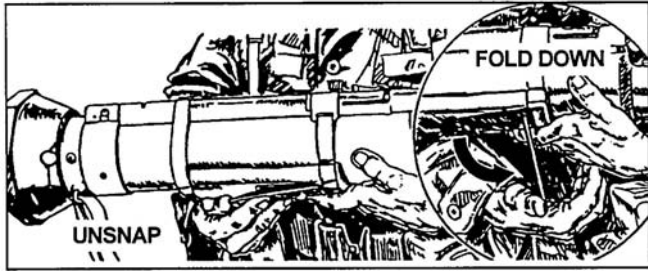

Figure 071-054-0001-4. Unsnapping the shoulder strap

- d. With the shoulder stop in position, place the launcher on the right shoulder.
- e. With the launcher on the right shoulder and supported with the left hand, release the front sight by pressing down on the sight cover and sliding it to the rear. Release the rear sight by pressing down on the cover and sliding it forward. Sliding the covers off allows the sights to pop up.
- f. Check the backblast area.
- g. Cock the launcher by unfolding the cocking lever with the right hand. Place the thumb of the right hand under the cocking lever. Grip the front of the firing mechanism for support. Push the cocking lever forward to the right. Let the cocking lever slide back (figure 071-054-0001-5).



Figure 071-054-0001-5. Cocking the launcher

- h. Adjust the rear sight for the required range.

## Performance Steps

(1) When closing the sight cover, set the sight on a range of 200 meters. Therefore, when the rear sight is uncovered, the battlesight setting is 200 meters. If the range to the target is more than 200 meters but less than 250 meters, no sight adjustment is required (figure 071-054-0001-6).

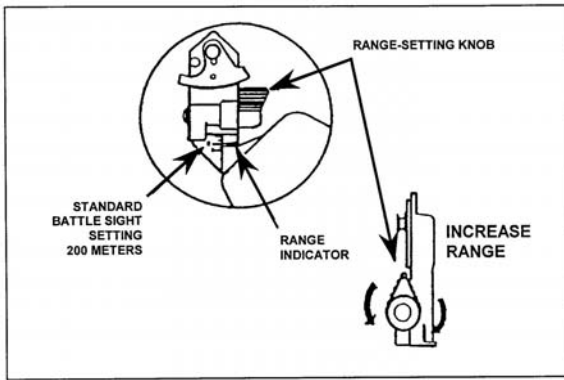

Figure 071-054-0001-6. Adjusting the rear sight

(2) To adjust the rear sight range setting to more than 200 meters, turn the range knob clockwise (toward the muzzle). To decrease the range, turn the range knob counterclockwise (toward the gunner). There is a click at each 50-meter increment; this sound aids you during limited visibility (figure 071-054-0001-6).

**Evaluation Preparation:** *Setup:* At the test site, provide an expended AT4 or a tracer trainer in the carrying configuration; have the Soldier place it in the carrying position. Tell the Soldier the range to the target. Ask the Soldier when the rear sight requires adjustment.

*Brief Soldier:* Tell the Soldier to prepare the launcher to fire. Tell the Soldier that he/she will be required to answer questions about the launcher.

Performance Measures	GO	NO GO
1. Performed the prefire checks.	___	___
a. Checked the transport safety pin.		
b. Ensured the cocking lever was on SAFE.		
c. Checked the fire-through muzzle cover.		
d. Checked the color-coded band.		
e. Checked the front and rear sights.		
f. Checked the red safety catch.		
g. Checked the rear seal.		
h. Checked the shoulder stop.		
i. Checked the carrying sling.		

Performance Measures	GO	NO GO
j. Checked the body of the launcher.	<input type="checkbox"/>	<input type="checkbox"/>
2. Prepared the launcher for firing.	<input type="checkbox"/>	<input type="checkbox"/>
a. Removed the transport safety pin.	<input type="checkbox"/>	<input type="checkbox"/>
b. Unsnapped and unfolded the shoulder stop.	<input type="checkbox"/>	<input type="checkbox"/>
c. Placed the launcher on the right shoulder.	<input type="checkbox"/>	<input type="checkbox"/>
d. Released the front and rear sights.	<input type="checkbox"/>	<input type="checkbox"/>
e. Checked the backblast area.	<input type="checkbox"/>	<input type="checkbox"/>
f. Cocked the launcher.	<input type="checkbox"/>	<input type="checkbox"/>
g. Adjusted the rear sight.	<input type="checkbox"/>	<input type="checkbox"/>

**Evaluation Guidance:** Refer to chapter 1, paragraph 1-9e, (1) and (2).

**References**

**Required:** FM 3-23.25

**Related:**

## 071-054-0002

### Restore an M136 Launcher to Carrying Configuration

**Conditions:** Given an M136 launcher (AT4) prepared for firing and the requirement to restore the launcher to carrying configuration.

**Standards:** Restore the launcher to a safe carrying configuration without damaging the equipment.

#### Performance Steps

*Note:* The launcher is prepared for immediate firing but is not fired.

1. If the gunner is to remain in the same position—
  - a. Release the red safety catch (this step applies only if the firing sequence has proceeded to this point).
  - b. Return the cocking lever to the SAFE (uncocked) position by pushing it up and to the left, then pulling it rearward. Fold the cocking lever down.
  - c. Keep the launcher pointed at the target area; remove the launcher from the shoulder.
  - d. With the launcher cradled in the left arm, replace the transport safety pin.
2. If the gunner is to move to another position, in addition to the steps shown above—
  - a. Return the rear sight to the battlesight setting of 200 meters, fold down the front and rear sights, and close the sight covers.

## Performance Steps

### CAUTION

The rear sight may be damaged if it is not returned to a battlesight setting of 200 meters before closing the sight cover.

- b. Fold the shoulder stop and snap it back into position.

**Evaluation Preparation:** *Setup:* At the test site, provide an expended AT4 or a tracer trainer. The AT4 or tracer trainer is in the ready-to-fire configuration.

*Brief Soldier:* Tell the Soldier to assume a correct standing, ready-to-fire position with the launcher. Once he/she has assumed the firing position, tell him/her to return the launcher to the carrying configuration.

Performance Measures	GO	NO GO
<i>Note:</i> The performance measures are scored in sequence.		
1. Released the red safety catch.	_____	_____
2. Returned the cocking lever to the SAFE position and folded the cocking lever down.	_____	_____
3. Removed the launcher from the shoulder and cradled it with the left arm.	_____	_____
4. Replaced the transport safety pin.	_____	_____
5. Returned the rear sight to the battlesight setting.	_____	_____
6. Folded the sights and closed the sight covers.	_____	_____
7. Folded the shoulder stop and snapped it in place.	_____	_____

**Evaluation Guidance:** Refer to chapter 1, paragraph 1-9e, (1) and (2).

### References

**Required:** FM 3-23.25

**Related:** TM 9-1315-886-12

## 071-054-0003

### Perform Misfire Procedures on an M136 Launcher

**Conditions:** Given an armed M136 launcher (AT4) that has misfired.

**Standards:** Apply misfire procedures so that the AT4 can be fired or ensure the weapon cannot fire. Inform the supervisor of the misfire.

## Performance Steps

1. Perform misfire procedures.
  - a. When the launcher fails to fire, immediately shout "MISFIRE."
  - b. Continue to hold the launcher pointed in the area of the target.
  - c. Release the red safety catch.

## Performance Steps

d. Immediately recock the cocking lever, check the backblast area, aim, fully depress and hold down the red safety catch, and press the red trigger button.

*Note:* If the launcher still fails to fire, repeat steps 1a through 1d above.

e. If the launcher again fails to fire, release the red safety catch and return the cocking lever to the SAFE (uncocked) position.

f. Remove the launcher from the shoulder while keeping the muzzle pointed toward the target area.

### WARNING

If the transport safety pin cannot be reinserted, do not move the weapon. Notify the noncommissioned officer in charge (NCOIC).

g. While cradling the launcher with the left arm, reinsert the transport safety pin.

*Note:* In a training situation only, after inserting the transport safety pin, wait 2 minutes. Keep the launcher pointed toward the target area.

h. Carefully lay the launcher on the ground with the muzzle pointed toward the target area.

2. Immediately use another launcher to engage the target.

**Evaluation Preparation:** *Setup:* At the test site, provide an expended AT4 or a tracer trainer in the ready-to-fire configuration.

*Brief Soldier:* Tell the Soldier to assume a correct standing, ready-to-fire position with the launcher. Tell the Soldier to go through the firing procedure and misfire procedures.

Performance Measures	GO	NO GO
<i>Note:</i> The performance measures are scored in sequence.		
1. Shouted "MISFIRE."	___	___
2. Released the red safety catch.	___	___
3. Recocked the cocking lever.	___	___
4. Tried to refire after checking the backblast area.	___	___
5. Repeated performance measures 1 through 4 when the launcher failed to fire.	___	___
6. Returned the red safety lever to the SAFE (uncocked) position.	___	___
7. Removed the launcher from the shoulder while keeping the muzzle pointed at the target area.	___	___
8. Replaced the transport safety pin.	___	___

Performance Measures	GO	NO GO
9. Placed the launcher on the ground with the muzzle pointed toward the target area.	_____	_____

**Evaluation Guidance:** Refer to chapter 1, paragraph 1-9e, (1) and (2).

**References**

**Required:**

**Related:** FM 3-23.25

**071-054-0004**

**Engage Targets with an M136 Launcher**

**Conditions:** Given an M136 launcher (AT4) prepared for firing, engageable targets, and a requirement to engage such targets.

**Standards:** Destroy or disable targets with the M136 launcher.

**Performance Steps**

*Note:* The launcher can only be fired from the right shoulder.

1. Firing position.
  - a. Four types of firing positions are used when firing the M136 launcher.
    - (1) The standing position (figure 071-054-0004-1).



**Figure 071-054-0004-1. Standing position**

- (2) The kneeling position with two variations (figure 071-054-0004-2).

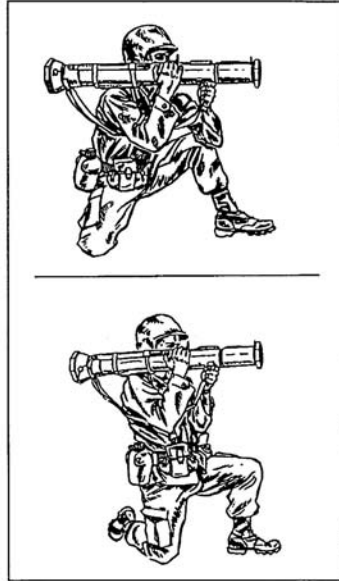

Figure 071-054-0004-2. First and second kneeling positions

- (3) The sitting position with two variations (figure 071-054-0004-3).

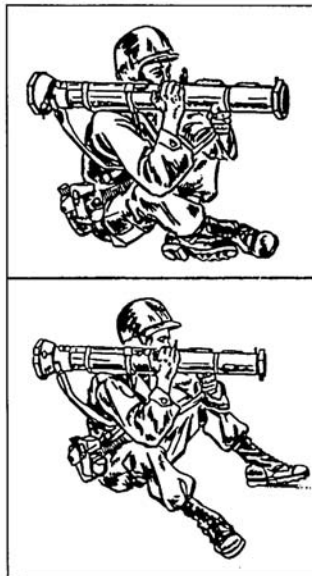

Figure 071-054-0004-3. First and second sitting positions

- (4) The prone position (figure 071-054-0004-4).

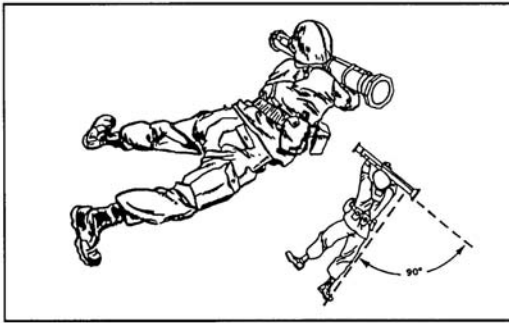

Figure 071-054-0004-4. Prone position

2. Using the sights.

a. Determine the range to the target. If the range is 250 meters or less, do not adjust the rear sight. If the range is more than 250 meters, adjust the rear sight to the required range.

**WARNING**

Do not place the eye against the rear sight when firing. Recoil may cause injury to the eye.

b. Obtain the correct sight picture (figure 071-054-0004-5). Align and properly place the sights in relation to the target. In Figure 5, notice that the top center of the front sight post is in the center of the rear sight peephole. Ensure that the white line on the front sight is just inside the peephole.



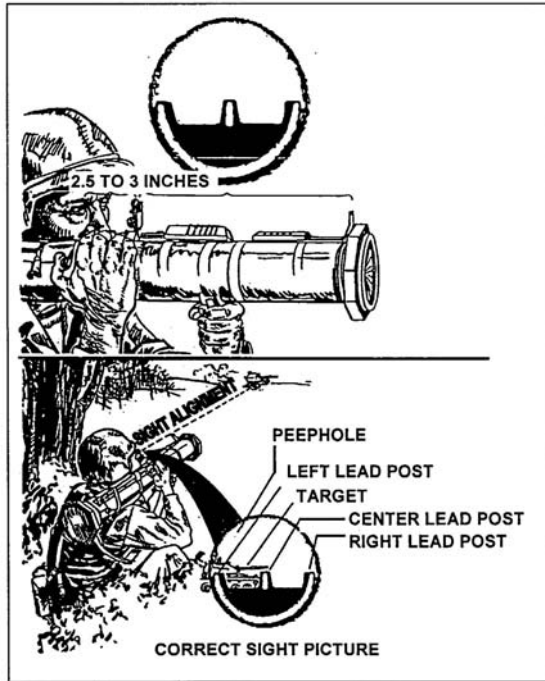
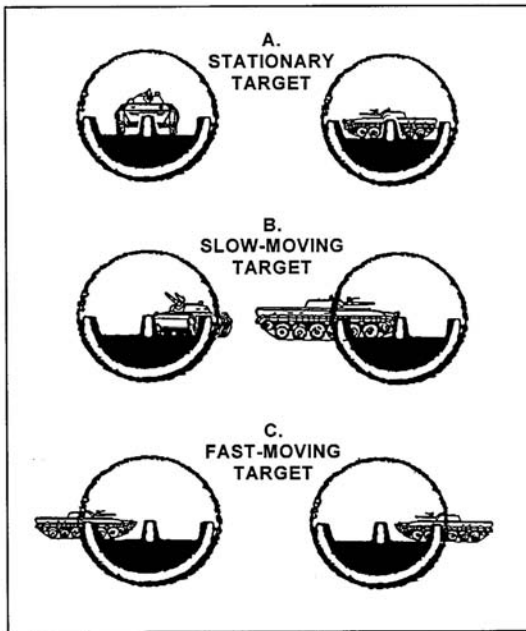

Figure 071-054-0004-5. Correct sight picture

(1) Stationary targets. Place the center post at the center of visible mass (A, figure 071-054-0004-6). This same procedure also applies for vehicles that are proceeding directly toward or away from the firer.



**Figure 071-054-0004-6. Correct placement of the front sight lead posts**

(2) Slow moving targets (less than 10 miles per hour). Place the center post on the front leading edge of the vehicle (B, figure 071-054-0004-6). This procedure also applies to vehicles moving at an oblique (at all speeds).

(3) Fast moving targets (more than 10 miles per hour).

(a) If the vehicle is moving from right to left, place the right hand lead post at the center of mass (C, figure 071-054-0004-6).

(b) If the vehicle is moving from left to right, place the left hand lead post at the center of mass (C, figure 071-054-0004-6).

### 3. Methods of engagement.

a. Single firing. In single firing, a target is engaged by one Soldier firing one launcher with no succeeding shots (figure 071-054-0004-7). This method should be used only at ranges of 200 meters or less.



Figure 071-054-0004-7. Single firing

b. Sequence firing. In sequence firing, one Soldier equipped with two or more launchers engages the target (figure 071-054-0004-8). He/she observes the impact of the first round. If it is a hit, he/she continues to fire until the target is destroyed. If the first round was a miss, the Soldier applies burst-on-target corrections until the target is hit.



Figure 071-054-0004-8. Sequence firing

c. Pair firing. In pair firing, two Soldiers equipped with two or more rounds each engage a single target (figure 071-054-0004-9). The Soldier who sees the target first identifies it and announces the estimated range and the lead that he/she will use, and then fires. The second Soldier observes the impact and announces a revised estimate of range and lead (if appropriate) and fires. Each Soldier continues exchanging range and lead information until the target is destroyed.



Figure 071-054-0004-9. Sequence firing by a pair of Soldiers

d. Volleying firing. In volley firing, a single target is engaged by more than one Soldier using the same sight data to fire one or more launchers (figure 071-054-0004-10). Volley firing should be used when the range to the target is known. Since more rounds are fired at the target, using this method increases the probability of hitting the target and obtaining a kill.



Figure 071-054-0004-10. Volley firing

4. Target vulnerability.

- a. An armored vehicle usually has its heaviest armor on the front slopes.

**Performance Steps**

b. Gunners should try to engage the armored vehicle's weak points, which are the sides and the rear (figure 071-054-0004-11).

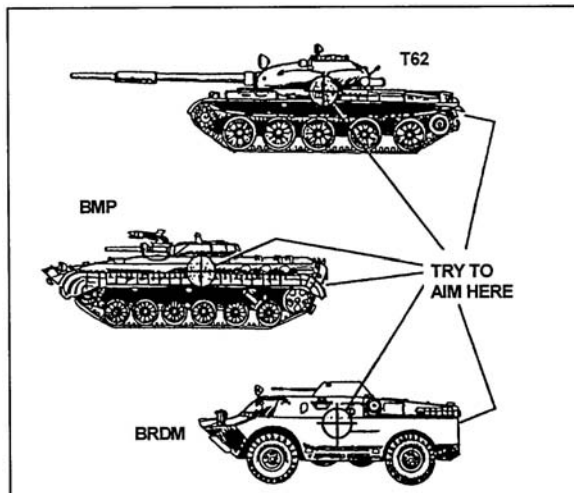

**Figure 071-054-0004-11. Vulnerable points on an armored vehicle**

**Evaluation Preparation:** *Setup:* At the test site, provide the Soldier with a tracer trainer, targets to be engaged, a replica of the sights, and pictures of the vehicles.

*Brief Soldier:* Tell the Soldier which firing position to use and which target to engage. Tell him/her that he/she must answer questions about firing the launcher.

Performance Measures	GO	NO GO
1. Assumed the given firing position.	___	___
a. Standing.		
b. Kneeling.		
c. Sitting.		
d. Prone.		
2. Adjusted the rear sight to the range when required.	___	___
3. Used the correct sight placement to engage the targets.	___	___
a. Stationary targets.		
b. Slow moving targets.		
c. Fast moving targets.		
d. Oblique moving targets.		
e. Head-on or rear targets.		

Performance Measures	GO	NO GO
4. Answered the questions on the methods of engagement.	___	___
a. Single firing.		
b. Sequence firing.		
c. Pair firing.		
d. Volley firing.		
5. Answered the questions on a target's weak points.	___	___

**Evaluation Guidance:** Refer to chapter 1, paragraph 1-9e, (1) and (2).

**References**

**Required:** FM 3-23.25

**Related:** TM 9-1315-886-12

**SUBJECT AREA 15: M203 GRENADE LAUNCHER**

**071-311-2125**

**Maintain an M203 Grenade Launcher**

**Conditions:** Given an M203 grenade launcher; cleaner, lubricant, preservative (CLP); thong; bore brush; and clean rags.

**Standards:** Clear; disassemble; clean and lubricate; inspect; (re)assemble; and perform a function check on an M203.

**Performance Steps**

1. Clear the M203 grenade launcher.
2. Disassemble the M203 (figure 071-311-2125-1).

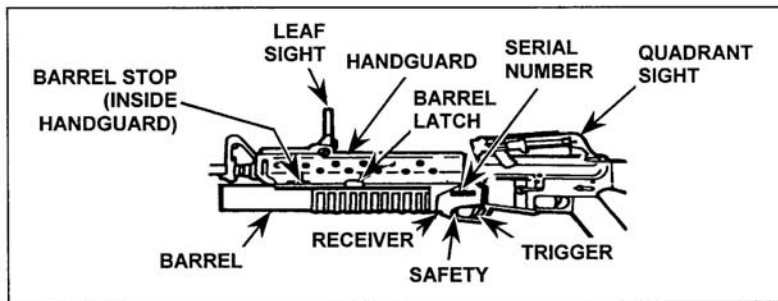

Figure 071-311-2125-1. Components of the M203 grenade launcher

**WARNING**

Before disassembling the weapon, clear the rifle and grenade launcher.

## Performance Steps

a. Remove the quadrant sight (if used) by loosening the knurled screw on the right side (figure 071-311-2125-2).

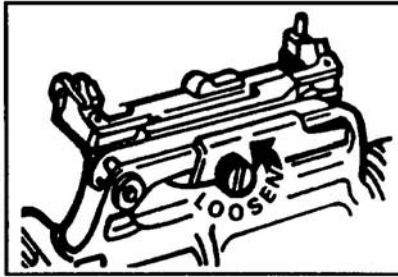

Figure 071-311-2125-2. Removing quadrant sight

b. Pull back the slip ring. Lift up on the handguard and pull it to the rear to remove (figure 071-311-2125-3).

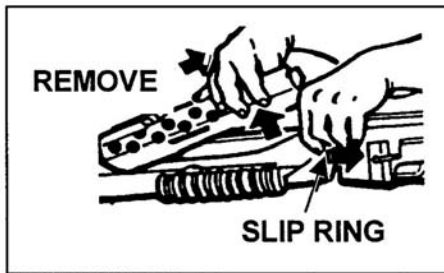

Figure 071-311-2125-3. Removing handguards

c. Press the barrel latch and move the barrel forward to the barrel stop (figure 071-311-2125-4).

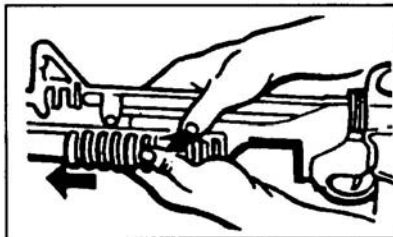

Figure 071-311-2125-4. Unlocking and opening the M203 barrel

d. Press the barrel stop to release the barrel from the receiver and remove the barrel (figure 071-311-2125-5).

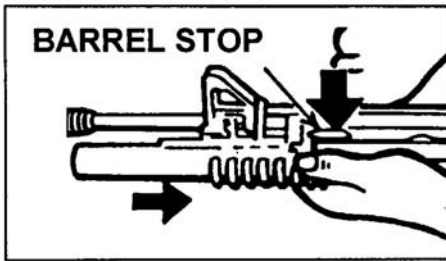

Figure 071-311-2125-5. Removing the M203 barrel

*Note:* Stop here; only the armorer may disassemble the weapon more than this.

3. Clean and lubricate the M203.

a. Bore. Attach a clean, dry rag to the thong and thoroughly moisten the rag with CLP. Pull the rag through the bore several times. Attach the bore brush to the thong, pull it through the bore several times, and follow this with more rags moistened with CLP, if needed (figure 071-311-2125-6). Pull dry rags through the bore and inspect each rag as you remove it. The bore is clean when a dry rag is removed unfouled. Pull a rag lightly moistened with CLP through the bore to leave a light coat of lubricant inside the barrel.

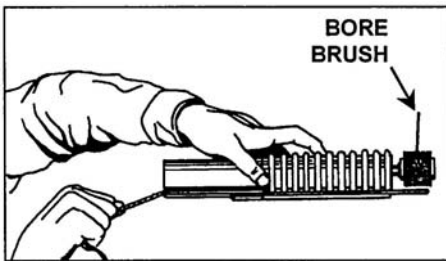

Figure 071-311-2125-6. Cleaning the M203 barrel

b. Breech insert. Clean the face of the breech insert retainer with a patch and CLP. Remove the CLP cleaner with dry rags, and then lubricate the breech with a light coat of CLP.

c. All other parts. Use a brush and dry rags to clean all other parts and surfaces. Apply a light coat of CLP to the exterior of the launcher after cleaning.

d. Safety mechanism. Clean the safety mechanism properly with CLP. Lubricate the safety with CLP.

4. Inspect the M203 before assembly.

a. Check the handguard for cracks, dents, or distortion that prevent firm attachment to the rifle.



## Performance Steps

- b. Check the leaf sight for bent or damaged parts and for rust or corrosion.
  - c. Check the leaf sight for legibility of marking.
  - d. Check the barrel for cracks and general condition. Inspect all parts for wear and damage.
  - e. Check for burrs, scratches, nicks, or other damage.
5. Assemble the M203.
- a. Press the barrel stop. Slide the barrel into the receiver (figure 071-311-2125-7).

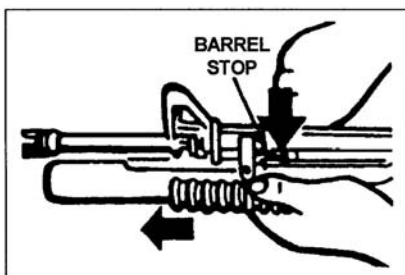

Figure 071-311-2125-7. Installing the M203 barrel

- b. Move the barrel rearward to lock (figure 071-311-2125-8).

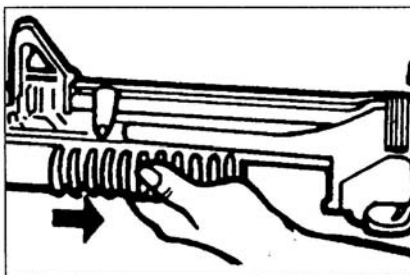

Figure 071-311-2125-8. Locking the M203 barrel

- c. Install the handguard and secure with the slip ring (figure 071-311-2125-9).
-

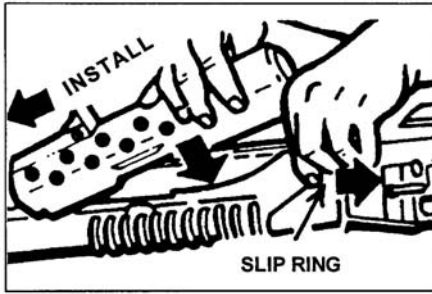

Figure 071-311-2125-9. Installing the handguards

- d. Install the quadrant sight (figure 071-311-2125-10).

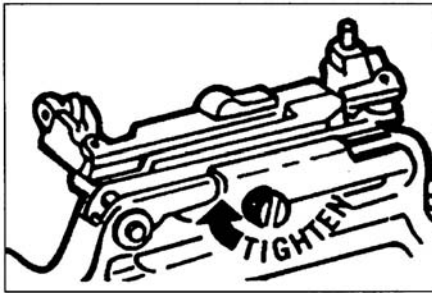

Figure 071-311-2125-10. Installing the quadrant sight

- 6. Perform a function check on the M203.
  - a. Check the proper operation of the sears. Cock the launcher and pull the trigger. The firing pin should release. Hold the trigger to the rear and cock the launcher. Release the trigger, then pull. The firing pin should release.
  - b. Check the safety in both SAFE and FIRE positions with the trigger. The launcher must be cocked before the safety can be placed in the SAFE position.
  - c. Check the leaf sight windage adjustment screw for proper operation. Do not move the elevation adjustment screw if the weapon has been zeroed.
  - d. Move the barrel forward and then back to be sure that the stop and barrel latch function.

**Evaluation Preparation:** *Setup:* At the test site, provide all materials and equipment listed in the task conditions statement.

*Brief Soldier:* Tell the Soldier to perform unit maintenance on the M203 grenade launcher.

Performance Measures		GO	NO GO
1.	Cleared the M203 grenade launcher.	_____	_____
2.	Disassembled the M203.	_____	_____
3.	Cleaned and lubricated the M203.	_____	_____
4.	Inspected the M203 before assembly.	_____	_____
5.	Assembled the M203.	_____	_____
6.	Performed a function check on the M203.	_____	_____

**Evaluation Guidance:** Refer to chapter 1, paragraph 1-9e, (1) and (2).

**References**

**Required:**

**Related:** FM 3-22.31 and TM 9-1010-221-10

## 071-311-2126

### Perform a Function Check on an M203 Grenade Launcher

**Conditions:** Given an M203 grenade launcher.

**Standards:** Determine if the M203 grenade launcher is functioning properly.

**Performance Steps**

**WARNING**

Ensure that the weapon is unloaded.

1. Check to ensure that the weapon is clear.
2. Check the operation of the sear.
  - a. Cock the launcher and squeeze the trigger; the firing pin should release.
  - b. Hold the trigger to the rear and cock the launcher.
  - c. Release and then squeeze the trigger; the firing pin should release.
3. Check the safety.
  - a. Cock the launcher.
  - b. Place the safety on SAFE and pull the trigger; the firing pin should not release.
  - c. Place the safety on FIRE and pull the trigger; the firing pin should release.
4. Move the barrel forward and then back and check to ensure that the stop and barrel latch function correctly.
5. Turn in the weapon to the unit armorer if it does not function correctly.

**Evaluation Preparation:** *Setup:* Provide the equipment in the task conditions statement.

*Brief Soldier:* Tell the Soldier to perform a function check on the M203 grenade launcher. Inform the Soldier to notify the evaluator if the M203 does not function correctly.

Performance Measures	GO	NO GO
1. Checked the operation of the sear.	___	___
2. Checked the safety.	___	___
3. Checked the barrel stop and the barrel latch.	___	___
4. Turned in the malfunctioning weapon to the unit armorer.	___	___

**Evaluation Guidance:** Refer to chapter 1, paragraph 1-9e, (1) and (2).

**References**

**Required:**

**Related:** TM 9-1010-221-10

---

## 071-311-2127

### Load an M203 Grenade Launcher

**Conditions:** Given an M203 grenade launcher, ammunition, and a requirement to load the weapon.

**Standards:** Insert ammunition into the chamber without damaging the equipment or injuring personnel, and follow all safety procedures according to TM 9-1010-221-10.

#### Performance Steps

**WARNING**

Keep the muzzle downrange and clear of all troops.

1. Ensure that the safety is in the SAFE ("S") position until ready to fire.
2. Depress the barrel latch.
3. Slide the barrel assembly forward (extraction and cocking automatically take place during this step).
4. Before loading, make sure the bore and chamber are clean and dry.
5. Insert the ammunition into the chamber.

**WARNING**

Never fire pyrotechnic ammunition made for the AN-M8 pyrotechnic pistol in the M203 grenade launcher. Make sure you have the right ammunition. Never load aircraft ammunition M384 (HE) or M385 (practice). Doing so could result in serious injury.

### Performance Steps

- Slide the barrel closed until it locks and clicks.

**Evaluation Preparation:** *Setup:* At the test site, in an outside field environment, provide all equipment and materials listed in the task condition statement.

*Brief Soldier:* Tell the Soldier to load the M203 grenade launcher and to perform all steps correctly.

Performance Measures	GO	NO GO
1. Ensured that the safety is in the SAFE ("S") position until ready to fire.	_____	_____
2. Pressed the latch and slid the barrel forward.	_____	_____
3. Before loading, ensured the bore and chamber were clean and dry.	_____	_____
4. Inserted the ammunition into the chamber.	_____	_____
5. Slid the barrel closed until it locked and clicked.	_____	_____

**Evaluation Guidance:** Refer to chapter 1, paragraph 1-9e, (1) and (2).

### References

#### Required:

**Related:** FM 3-22.31 and TM 9-1010-221-10

---

## 071-311-2128-T

### Unload an M203 Grenade Launcher

**Conditions:** Given a loaded M203 grenade launcher and a requirement to unload it.

**Standards:** Press the latch and move the barrel forward to eject ammunition and catch the round as it drops.

### Performance Steps

*Note:* If the weapon has been fired and only a shell casing is in the chamber, disregard step 3 and the requirement for slow movement in step 4.

- Place the safety in the ON position.
- Depress the barrel latch.
- Place one hand under the barrel assembly forward of the trigger guard.
- Slowly slide the barrel assembly forward (the round will eject).
- Secure the round.

**Evaluation Preparation:** *Setup:* At the test site, in an outside field environment, provide all equipment and materials listed in the task conditions statement.

*Brief Soldier:* Tell the Soldier to unload the M203 grenade launcher, performing all steps correctly.

Performance Measures	GO	NO GO
1. Pressed the latch.	___	___
2. Moved the barrel forward.	___	___
<i>Note:</i> The round extracted and ejected automatically.		
3. Caught the round—kept it from dropping.	___	___

**Evaluation Guidance:** Refer to chapter 1, paragraph 1-9e, (1) and (2).

**References**

**Required:**

**Related:** FM 3-22.31 and TM 9-1010-221-10

## 071-311-2129

### Correct Malfunctions of an M203 Grenade Launcher

**Conditions:** Given an M203 grenade launcher mounted on an M16-series rifle, a failure of the M203 to function or fire, and 40-mm M203 ammunition.

**Standards:** Correct malfunctions of an M203 grenade launcher. Follow all safety precautions according to TM 9-1010-221-10.

#### Performance Steps

1. Keep the weapon pointed at the target, and keep all Soldiers at least 80 meters (264 feet) from the muzzle.

*Note:* M203 malfunctions consist of hangfires and misfires. A hangfire is a delayed propellant ignition. A misfire is a failure to fire. Handle both the same way. The two situations are often indistinguishable.

2. Wait 30 seconds from the time of the failure to fire, and then open the breech.

3. Remove the round from the breech.

a. Release the barrel latch.

b. Slide the barrel forward to eject the round.

c. Either catch the ejected round, or reduce the distance the round falls by holding the weapon close to the ground.

d. If the round fails to eject, tap the casing with the rifle cleaning rod.

e. If the casing is stuck in the weapon, notify the noncommissioned officer in charge (NCOIC) or unit maintenance.

4. Examine the primer to determine whether the round or the firing mechanism is defective.

a. If the primer is dented, keep the damaged round separate from other ammunition until it can be disposed of properly.

### Performance Steps

b. If the primer is undented, then the firing mechanism is faulty. Report it to the NCOIC or unit maintenance.

*Note:* If the primer is not dented, you can reload it into an operational M203.

**Evaluation Preparation:** *Setup:* Provide all materials listed in the task condition statement. Use dummy ammunition for training.

*Brief Soldier:* Tell the Soldier that he/she must assume a firing position to apply any required immediate action.

Performance Measures	GO	NO GO
1. Kept the weapon pointed at the target and all troops at least 80 meters (264 feet) from the muzzle.	_____	_____
2. Waited 30 seconds from the time of the failure to fire, and then opened the breech.	_____	_____
3. Removed the round from the breech.	_____	_____
4. Examined the primer to determine whether the round or the firing mechanism was defective.	_____	_____

**Evaluation Guidance:** Refer to chapter 1, paragraph 1-9e, (1) and (2).

### References

#### Required:

**Related:** FM 3-22.31 and TM 9-1010-221-10

## 071-311-2130

### Engage Targets with an M203 Grenade Launcher

**Conditions:** Given a zeroed M203 grenade launcher mounted on an M16-series or M4-series rifle, enemy targets located within engagement ranges, and sufficient ammunition to perform the task.

**Standards:** Destroy or disable enemy targets without causing injury or death to friendly personnel.

### Performance Steps

*Note:* This task may be performed using either of two sights found on the system.

#### WARNING

Keep the muzzle pointed downrange and clear of all friendly troops.

1. Keep the safety in the SAFE position until ready to fire.
2. Load the M203 grenade launcher.

**WARNING**

IN TRAINING—Fire high explosive (HE) grenades at targets within 130 meters (427 feet, the minimum safe firing range) only from a protected position. Otherwise, avoid firing at targets within 130 meters (427 feet).

IN COMBAT—In combat, never fire at targets within 31 meters (102 feet).

3. Determine the range to the target (figure 071-311-2130-1).

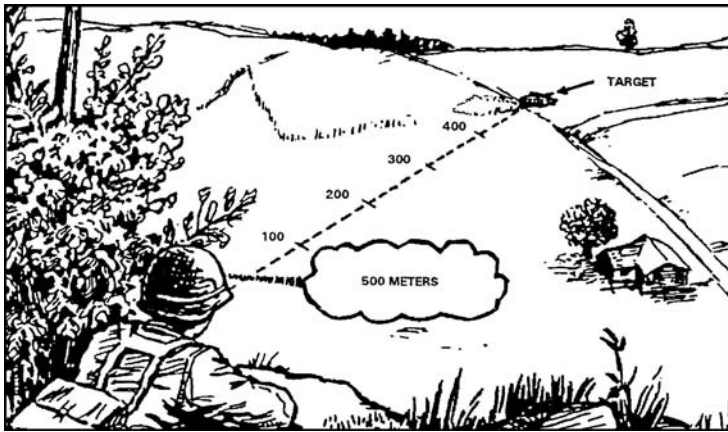

Figure 071-311-2130-1. Range estimation

4. Determine if you can engage the target.
5. Determine if you should engage the target.
6. Select the appropriate firing technique based on the target range (figure 071-311-2130-2).



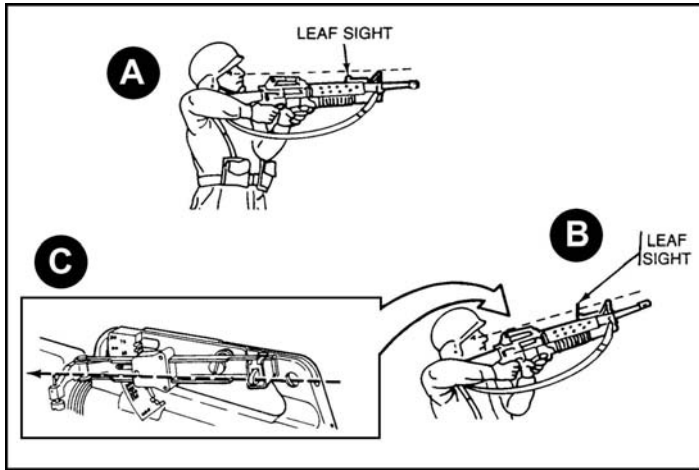

Figure 071-311-2130-2. Firing techniques

a. For short-range targets at 50 meters or less, place the leaf sight down and use the rifle sights (A, figure 071-311-2130-2).

*Note:* Estimate the distance to the target and aim the head high on the target.

b. For targets from 50 to 250 meters, raise the leaf sight and use with the front rifle sight (B, figure 071-311-2130-2).

c. For targets from 250 to 400 meters, use the front and rear sight of the quadrant sight only (C, figure 071-311-2130-2).

7. Select and assume an appropriate firing position (figure 071-311-2130-3).

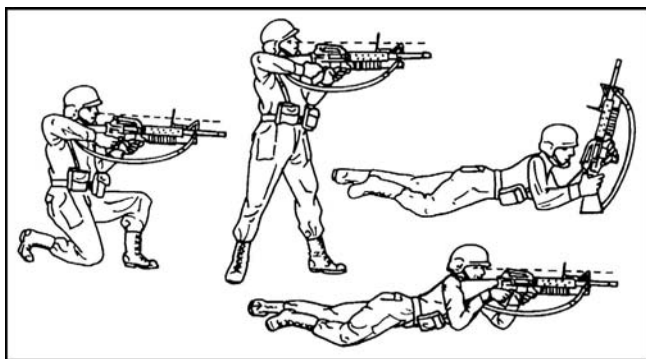

Figure 071-311-2130-3. Firing positions

*Note:* You can fire the launcher from the standing, kneeling, or prone position.

a. Place the stock of the weapon on the ground when firing long range from the prone position.

## Performance Steps

b. Hold the stock firmly against your shoulder for all other positions.

8. Obtain the sight picture (leaf sight or quadrant sight).

*Note:* Use either sight between 50 and 250 meters. Use only the quadrant sight between 250 and 400 meters.

9. Adjust the leaf sight if necessary (figure 071-311-2130-4). Use the rim of a used 40-mm cartridge to turn the elevation adjustment screw.

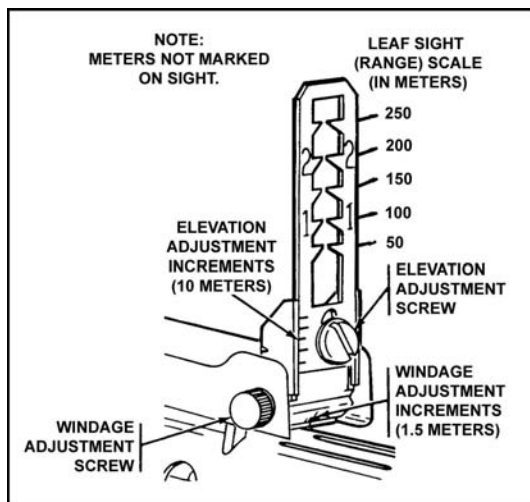

Figure 071-311-2130-4. Leaf sight

*Note:* For range, the leaf sight scale is marked in 50-meter (165-foot) increments for targets from 50 to 250 meters.

*Note:* For elevation, one increment equals 10 meters (33 feet) at a 200-meter (660-foot) range.

*Note:* For windage, one increment equals 1.5 meters (5 feet) at a 200-meter (660-foot) range.

a. For head wind and rear wind—

(1) Increase the range to compensate for a head wind by loosening the elevation adjustment screw, which raises the leaf sight.

(2) Decrease the range to compensate for a rear wind by tightening the elevation adjustment screw, which lowers the leaf sight.

b. For left wind and right wind—

(1) Turn the windage adjustment screw clockwise to adjust for wind from the left.

(2) Turn the windage adjustment screw counterclockwise to adjust for wind from the right.

10. Adjust the quadrant sight if necessary (figure 071-311-2130-5).

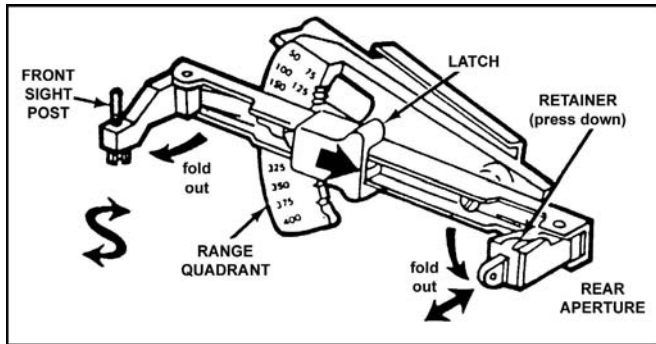

Figure 071-311-2130-5. Quadrant sight

**Note:** Range quadrant is marked in 25-meter (83-foot) increments from 50 to 400 meters (165 to 1,320 feet).

- a. Pull the latch toward you to release the quadrant sight arm.
- b. Select the elevation.

**Note:** For elevation adjustment, one notch equals 5 meters (17 feet) at a 200-meter (660-foot) range.

- c. For head wind and rear wind—
  - (1) Increase range to compensate for a head wind by turning the front sight post left.
  - (2) Decrease range to compensate for a rear wind by turning the front sight post right.
- d. For left wind and right wind—
  - (1) To adjust for wind from the right, depress the retainer and slide the rear aperture in.
  - (2) To adjust for wind from the left, depress the retainer and slide the rear aperture out.

**Note:** The vertical line marks center. One notch = 1.5 meters (5 feet) at a 200-meter (660-foot) range.

11. Move the safety to the FIRE position.

### WARNING

Be sure there are no obstacles (such as the sling or branches) in the line of fire.

12. Aim and squeeze the trigger to fire.

**Note:** Practice breath control when firing the rifle.

13. If the first round misses, adjust fire as necessary by sensing the impact of the round and manipulating the sight.

## Performance Steps

**Note:** Continue the adjustment process until you hit the target or until the area has been covered by fire.

- a. If time allows, whether using the AN/PVS-4 or AN/PVS-7, adjust the sights. If time is critical, adjust the point of aim instead.
- b. If the grenade lands more than 25 meters over or short of the target, adjust the range quadrant to bring the next grenade on target.
- c. If the grenade explodes less than 25 meters from the target, adjust the point of aim to bring the next grenade on target.
- d. If the launcher is properly zeroed, deviation errors will be small and you can easily correct them by adjusting the aiming point. Adjust for wind as described in step 9 and step 10.

**Evaluation Preparation:** *Setup:* At a live-fire M203 range, provide all the materials listed in the task condition statement.

*Brief Soldier:* Tell the Soldier to engage targets at ranges from 50 to 250 meters in his/her sector of fire.

Performance Measures	GO	NO GO
1. Kept the safety in the SAFE position until ready to fire.	___	___
2. Loaded the M203 grenade launcher.	___	___
3. Determined the range to target.	___	___
4. Selected the appropriate firing technique based on the target range.	___	___
5. Selected the firing position.	___	___
6. Adjusted the leaf sight.	___	___
7. Adjusted the quadrant sight.	___	___
8. Moved the safety to the FIRE position.	___	___
9. Aimed and squeezed the trigger to fire.	___	___
10. Adjusted fire by sensing the impact of the round and manipulating the sight.	___	___

**Evaluation Guidance:** Refer to chapter 1, paragraph 1-9e, (1) and (2).

### References

#### Required:

**Related:** FM 3-22.31 and TM 9-1010-221-10

**071-100-0001**

**Zero an M4 or M4A1 Carbine**

**Conditions:** On a 25-meter range, given an M4 or M4A1 carbine; 18 rounds of 5.56-mm ammunition; a 25-meter zero target; and sandbags for support.

**Standards:** Fire and adjust sights on the M4 or M4A1 carbine so that a three-round shot group(s) centered on the white dot at the center of the zero target uses 18 rounds or less.

**Performance Steps**

1. Establish a mechanical zero for the carbine.
  - a. Flip up the unmarked, long-range aperture on the rear sight.

*Note:* Do not move the front sight post at this time.

- b. Center the rear sight aperture by turning the windage knob left or right. Align the index mark on the 0-2 aperture with the center line on the windage scale and the mark on the receiver.

- c. Rotate the elevation knob counterclockwise (down) until the range scale stops on the 300-meter mark (6/3). Take the rear sight all the way down until you hear the last whole "click" before it bottoms out.

- d. Rotate the elevation knob two clicks clockwise (up) past the 300-meter setting. Leave the elevation knob on the 300-meter setting (6/3). Make any further elevation corrections to the front sight post only.

*Note:* The sight picture is obtained by aligning the rear sight and the front sight with the proper aiming point for your target. The sight picture depends on sight alignment and placement of the aiming point.

2. Establish a correct sight picture.
  - a. Check to ensure that the carbine side of the 25-meter target is facing you.
  - b. Assume a supported fighting position.
  - c. Load the weapon.
  - d. Align the sights.
    - (1) Center the top of the front sight post in the center of the rear sight.
    - (2) Draw an imaginary horizontal line through the center of the rear aperture so that the top of the front sight post touches the line.
    - (3) Draw an imaginary vertical line through the center of the rear aperture that bisects the front sight post.
    - (4) Verify the sight picture.

*Note:* When you concentrate on the front sight post, the rear sight aperture will be blurred.

## Performance Steps

- e. Align the aiming point.
  - (1) Aim at target center.
  - (2) Position the top of the front sight post center mass of the scaled silhouette target.
  - (3) Confirm that an imaginary vertical line drawn through the center of the front sight post splits the target.
  - (4) Confirm that an imaginary horizontal line drawn through the top of the front sight post splits the target.
3. Establish a three-round shot group 4 centimeters or less in diameter.
  - a. Fire a three-round shot group at the target.
  - b. Triangulate the shot group on the target.
  - c. Repeat step a and step b until the shot group is 4 centimeters or less in diameter.

*Note:* Vertical and horizontal lines divide the target. It also has pictures of the front and rear sights with a direction arrow to assist you with adjusting the sights.

4. Adjust the sights to move the shot group to the white dot in the center of the target.

*Note:* Do not adjust the sights if the shot group meets the standard.

- a. If your shot group is not in the center of the bull's eye, use the squares on the target to calculate the number of clicks required to move your next shot group close to the white dot. The numbered squares around the edges of the target each represent a click on the sight.
  - (1) Elevation. One click will move the strike of the bullet up or down one square on the target sheet.
    - (a) To move the shot group down, rotate the front sight post clockwise.
    - (b) To move the shot group up, rotate the front sight post counterclockwise.
  - (2) Windage. Three clicks will move the strike of the bullet one square left or right.
    - (a) To move the shot group to the left, turn the windage knob counterclockwise.
    - (b) To move the shot group to the right, turn the windage knob clockwise.
- b. Keep track of adjustments.
- c. Fire a three-round shot group.
- d. Repeat step a until the shot group centers on the white dot in the center of the target.

## Performance Steps

e. Rotate the rear sight elevation knob counterclockwise (down) two clicks to the 300-meter setting. The weapon is zeroed for 300-meter battle sight.

f. Compute and record battle-sight zero. See the example shown in figure 071-100-0001-1.

COMPUTATION		EXAMPLES	
		FRONT	REAR
Begin with mechanical zero (or previous battle-sight zero)			Centered
Compute first adjustment	Add clicks right or up	-(D)2	+(R)5
	Subtract clicks left or down		
Compute second adjustment (Include additional corrections if necessary)		+(U)5	-(L)1
Calculate battle-sight zero (Total)		U3	R4

Figure 071-100-0001-1. Example of battlesight zero computation

**Evaluation Preparation:** *Setup:* On a 25-meter firing range, the Soldier has an assigned rifle and magazine. Give the Soldier 18 rounds of 5.56-mm ball ammunition and a sandbag for support.

**Note:** You can train rifle marksmanship skills using *any* and all rifle marksmanship training devices (such as Weaponeer, Basic Rifle Marksmanship, DVC 07-57). The live-fire evaluation of a Soldier's ability to zero the rifle requires firing on the standard zero range. The performance of this task for the common task test (CTT) can be done in conjunction with live-fire on the standard zero range or during a unit weapon qualification firing cycle.

**Brief Soldier:** Tell the Soldier to battle-sight zero the rifle using no more than 18 rounds. Provide a scenario that requires the Soldier to establish a mechanical zero.

Performance Measures	GO	NO GO
1. Established a mechanical zero for the carbine.	_____	_____
a. Flipped up the unmarked, long-range aperture on the rear sight.		
b. Centered the rear sight aperture by turning the windage knob left or right.		
c. Rotated the elevation knob counterclockwise (down) until the range scale stopped on the 300-meter mark (6/3).		
d. Rotated the elevation knob two clicks clockwise (up) past the 300-meter setting.		
2. Established a correct sight picture.	_____	_____
a. Checked to ensure the carbine side of the 25-meter target was faced you.		
b. Assumed a supported fighting position.		

Performance Measures	GO	NO GO
c. Loaded the weapon.		
d. Aligned the sights.		
e. Aligned the aiming point.		
3. Established a three-round shot group 4 centimeters or less in diameter.	_____	_____
a. Fired a three-round shot group at the target.		
b. Triangulated the shot group on the target.		
c. Repeated step a and step b until the shot group measured 4 centimeters or less in diameter.		
4. Adjusted the sights to move the shot group center to the white dot in the center of the target.	_____	_____
a. If your shot group was not in the center of the bull's eye, used the squares on the target to calculate the number of clicks required to move your next shot group close to the white dot. (The squares are numbered around the edges of the target to help you see how many clicks you need to move the shot group to the white dot.)		
b. Tracked adjustments.		
c. Fired a three-round shot group.		
d. Repeated until a shot group centered on the white dot in the center of the target.		
e. Rotated the rear sight elevation knob counterclockwise (down) two clicks to the 300-meter setting.		
f. Computed and recorded battlesight zero.		

**Evaluation Guidance:** Refer to chapter 1, paragraph 1-9e, (1) and (2).

### References

#### Required:

**Related:** TM 9-1005-319-10

## 071-100-0003

### Engage Targets with an M4 or M4A1 Carbine

**Conditions:** Given an M4 or M4A1 carbine, magazines, ammunition, individual combat equipment, and stationary or moving targets (personnel or equipment) at engageable ranges.

**Standards:** Detect and determine range to targets. Fire the M4 or M4A1 carbine, engage targets in the assigned sector of fire, and apply correct marksmanship



fundamentals and target engagement techniques so that each target is hit or suppressed.

---

### Performance Steps

---

1. Assume an appropriate firing position based on the situation. The firing position should protect you from enemy fire and observation, yet allow you to place effective fire on targets in your sector of fire.
    - a. Foxhole. Advantages: best when available. Disadvantages: no overhead cover.
    - b. Prone. Advantages: steady, easy to assume, low silhouette, and easily adapted to use of cover and support. Disadvantages: effectiveness can be limited by terrain and vegetation irregularities.
    - c. Prone supported. Advantages: steadier than prone; other advantages the same as prone. Disadvantages: same as prone.
    - d. Kneeling. Advantages: used when firing from behind something; used on ground that is level or gently sloping upward. Disadvantage: exposed to small arms fire.
    - e. Kneeling supported. Advantages: steadier than kneeling; other advantages the same as kneeling. Disadvantages: exposed to small arms fire.
    - f. Standing. Advantages: used in assault to surprise targets or when other positions are not appropriate. Disadvantages: exposed to small arms fire.
  2. Identify targets in your designated sector of fire.
  3. Determine range to a target.
    - a. Your M4 or M4A1 carbine sights can be used to estimate range to targets(s). Viewed through the front sight, a man-sized target appears—
      - (1) Twice the width as the front sight post at about 90 meters.
      - (2) The same width as the front sight post at about 175 meters.
      - (3) Half the width of the front sight post at about 350 meters.
  4. Load and fire on targets using appropriate engagement techniques.
    - a. Load the weapon.
    - b. Use the appropriate aiming technique.
      - (1) Engage a stationary target using reference points or sighting points.
      - (2) Engage a target moving towards you as you would a stationary target.
      - (3) Engage a target moving laterally, using the new single lead technique, by placing the trailing edge of the front sight post at the center of the target. This method causes the lead to increase automatically as the range increases.
-

## Performance Steps

- (4) Engage multiple targets by first firing at the one presenting the greatest danger (usually the closest) and then rapidly proceeding to the next target.
- c. Use the quick-fire technique when there is no time to properly aim. Use this technique on targets within 30 meters of your location. (This technique is most effective in urban terrain or heavy bush.)
- (1) Use the standing position.
  - (2) Use the raised stock well, looking 2 or 3 inches above the sights, on a plane that is level with the barrel.
  - (3) Look at the target, NOT at the sights.
- d. Fire on the targets until they are destroyed or until you receive an order to cease fire.

**Evaluation Preparation:** *Setup:* On a live-fire range, provide sufficient quantities of equipment and ammunition to support the number of Soldiers tested. Have each Soldier use his/her own rifle and magazine.

*Brief Soldier:* Tell Soldier that he/she is to detect and engage targets in his/her sector, and when asked, state the range to the target.

Performance Measures	GO	NO GO
1. Assumed an appropriate firing position based on the situation.	_____	_____
2. Identified targets in your designated sector of fire.	_____	_____
3. Determined the range to a target.	_____	_____
4. Loaded and fired on targets using the appropriate engagement techniques.	_____	_____

**Evaluation Guidance:** Refer to chapter 1, paragraph 1-9e, (1) and (2).

### References

#### Required:

**Related:** FM 21-75, FM 3-22.9, and TM 9-1005-319-10

## 071-100-0004

### Maintain an M4 or M4A1 Carbine

**Conditions:** Given an M4 or M4A1 carbine, magazine, 5.56-mm ammunition, and small-arms accessory case with the following cleaning materials: clean wiping rags; bore brush; chamber brush; toothbrush; cleaning rod; small arms swabs; pipe cleaners; cleaner, lubricant, and preservative (CLP); lubricating oil, arctic weather (LAW); and carbine bore cleaner.

**Standards:** Clean, inspect, and lubricate the carbine and magazine so that they function correctly; clean and inspect the ammunition; turn in any unserviceable ammunition.

## Performance Steps

1. Clear the carbine.
  - a. Remove the magazine from the carbine. If there is one present.
  - b. Cock the carbine.
  - c. Turn the selector to SAFE.

*Note:* The selector cannot be turned to SAFE unless the carbine is cocked.

- d. Lock the bolt open.
    - (1) Pull the charging handle rearward.
    - (2) Press the bottom of the bolt catch.
    - (3) Allow the bolt to move forward until it engages the bolt catch.
    - (4) Return the charging handle to the forward position.
    - (5) Ensure the selector is on SAFE.
  - e. Check the receiver and chamber to ensure that they do not contain ammunition.
2. Disassemble the carbine.

### CAUTION

Do not use a screwdriver or any other tool when removing the handguards. Doing so may damage the handguards, slip ring, or both.

### WARNING

Use care not to bend or dent the gas tube while removing the handguards.

- a. Remove the sling.
- b. Remove the handguards only if you can see dirt or corrosion through the vent holes. Handguards are interchangeable because they are identical.

### CAUTION

Use only hand pressure to disengage the pivot and takedown pins. Force other than hand pressure may cause damage to the weapon so that replacement of the weapon is required. Push the pivot and takedown pins only far enough to disengage the upper receiver from the lower receiver.

- c. Push the takedown pin as far as it will go and pivot the upper receiver from the lower receiver.
- d. Push the receiver pivot pin.
- e. Separate the upper and lower receivers.
- f. Pull back the charging handle.
- g. Remove the bolt carrier and bolt.
- h. Remove the charging handle.

**CAUTION**

Do not fully remove the round nuts from the threaded studs. The threaded studs are flared on the end to prohibit removal. However, if the nuts are inadvertently removed, they may be reinstalled.

- i. Remove the carrying handle assembly. Loosen the round nuts on the left side of the carrying handle approximately four turns. Loosen the clamping bar from the left side of the upper receiver and lift off of the carrying handle.
- j. Remove the firing pin retaining pin.
- k. Put the bolt assembly in the locked position by pushing in the bolt.
- l. Remove the firing pin by allowing it to drop out of the rear of the bolt carrier and into your hand.
- m. Remove the bolt cam pin by turning it  $\frac{1}{4}$  turn and lifting it out.
- n. Pull the bolt assembly from the carrier.

*Note:* Perform steps o through q only when the parts are dirty or damaged.

- o. Press the rear of the extractor pin to check the spring function. Report any weak springs to the unit armorer for replacement.
- p. Remove the extractor pin by pushing it out with the firing pin (use care not to damage the firing pin).
- q. Lift out the extractor and spring, taking care that the spring does not separate from the extractor.
- r. Release the buffer by pressing the buffer and depressing the retainer.
- s. Remove the buffer and action spring separating the buffer from the spring.
- t. Extend the buttstock assembly to full open. The M4/M4A1 has a four position buttstock—closed,  $\frac{1}{2}$  open,  $\frac{3}{4}$  open, and full open.
- u. Grasp the lock lever in the area of the retaining nut, pull downward, and slide the buttstock to the rear to separate the buttstock assembly from the lower receiver extension.

**3. Clean the carbine.**

- a. Upper receiver group.
  - (1) Use small arms swabs, CLP, and bore brush to clean the bore.
  - (2) Use rags, cleaning brush, and CLP to remove powder fouling, corrosion, dirt, and rust from other areas.
  - (3) Clean the bolt lugs with CLP and the chamber brush.
  - (4) Use CLP and the bore brush to clean the barrel locking lugs and gas tube.
- b. Lower receiver group.

## Performance Steps

- (1) Remove powder fouling, corrosion, and dirt with rags, cleaning brush, and CLP.
- (2) Clean the buffer tube and buttstock tube with a rag attached to the holder.
- (3) Clean the buffer action spring and the inside lower receiver extension with a brush and rags.
- c. Bolt carrier group.
  - (1) Clean the outer and inner surfaces of bolt carrier with rags and CLP.
  - (2) Clean the carrier key (use a worn bore brush).
  - (3) Clean the firing pin recess and firing pin with brush and CLP.
  - (4) Clean the firing pin hole with pipe cleaner and CLP.
  - (5) Clean carbon deposits and dirt from the locking lugs with a cleaning brush and CLP.
  - (6) Clean the areas behind the bolt ring and under the lip of the extractor with a brush and CLP.
4. Inspect the carbine for serviceability.
  - a. Upper receiver group.
    - (1) Check for free movement of the forward assist assembly.
    - (2) Check for a broken or damaged ejection port cover.
    - (3) Check the rear sight windage and elevation knob for damage and looseness.
    - (4) Check the carrying handle assembly for missing or damaged parts and ensure the handle assembly will mount to the upper receiver.
    - (5) Check the front sight assembly for damage.
    - (6) Inspect the bore and chamber for pitting or obstructions.
    - (7) Inspect the bolt lugs for cracks and burrs.
    - (8) Check for free movement of the slip ring.
    - (9) Check the compensator for proper alignment.

*Note:* The compensator has five slots. The third or middle slot should line up with the front sight post. If not, turn in for maintenance.

    - (10) Check the bolt guide rails for chips and burrs.
  - b. Lower receiver.
    - (1) Check the trigger mechanism for missing or damaged parts.
    - (2) Check the bolt catch for free movement.
    - (3) Check the magazine release button for free movement.
    - (4) Check the buttstock assembly for dents, and rust and ensure proper operation of the retaining nut and the lock-release lever.
    - (5) Check the action spring and buffer for damage.
  - c. Bolt carrier group.
    - (1) Check the bolt carrier for chips, burrs, and cracks.
    - (2) Check the bolt for cracks or fractures, especially in the cam pin hole area. Bolts that contain pits in the firing pin hole need replacing.

## Performance Steps

- (3) Check the firing pin retaining pin for bends and excessive wear.
- (4) Check the firing pin for bends, cracks, and blunted or sharp end.
- (5) Check the cam pin for cracks and chips.
- (6) Check the extractor for chipped or broken edges in the area of the lip that engages the cartridge rim. Check to ensure the rubber insert is inside the extractor spring.

d. Report and turn in unserviceable parts for maintenance.

5. Lubricate the carbine.

*Note:* Under all but the coldest arctic conditions, CLP is the lubricant to use on the carbine. Between +10 degrees Fahrenheit and -10 degrees Fahrenheit, either CLP or LAW can be used. For -35 degrees Fahrenheit or lower, use LAW only.

*Note:* Lightly lube means apply a film of lubricant barely visible to the eye.

*Note:* Generously lube means apply the lubricant heavily enough so that it can be spread with the finger.

a. Upper receiver and carrying handle.

(1) Upper receiver. Lightly lube the inside of the receiver, bore, chamber, locking lugs, outer surfaces of the barrel and front sight, and mating surface for the carrying handle.

(2) Carrying handle. Apply a drop or two of lubricant to both threaded studs. Lightly lube the clamping bar and both round nuts. Lightly lube the mating surface.

(3) Front sight detent. Depress and apply two or three drops of CLP to the front sight detent. Depress several times to work the lube into the spring.

(4) Adjustable the rear sights. Use one or two drops of CLP. Rotate the following parts to ensure the lubricant is spread evenly above and below:

- Elevation screw shaft.
- Elevation knob.
- Windage knob.
- Windage screw

b. Lower receiver group.

(1) Lightly lube inside and outside the lower receiver extension, buffer, and action spring. Lightly lube the inside buttstock assembly. Generously lube the buttstock lock-release lever and retaining pin.

(2) Generously lube the takedown pin, pivot pin, detents, and all other moving parts and their pins.

c. Bolt carrier group.

(1) Lightly lube the charging handle and the inner and outer surfaces of the bolt carrier.

(2) Place one drop of CLP in the carrier key.

(3) Apply a light coat of CLP on the firing pin and firing pin recess in the bolt.

(4) Generously lube the outside of the bolt body, bolt rings, and cam pin area.

## Performance Steps

- (5) Apply a light coat of CLP on the extractor and pin.
6. Assemble the carbine.
  - a. Install the buttstock assembly. Align the buttstock assembly with the lower receiver extension; pull downward on the lock release lever near the retaining pin, and slide the buttstock assembly onto the lower receiver extension.
  - b. Insert the action spring and buffer.
  - c. Insert the extractor and spring.
  - d. Push in the extractor pin.
  - e. Slide the bolt into the carrier.

### WARNING

Be sure the cam pin is installed in the bolt group. If it is not, the carbine can still fire and will explode.

- f. Replace the bolt cam pin.
- g. Drop in and seat the firing pin.
- h. Pull the bolt back.
- i. Replace the retaining pin.
- j. Engage, and then push the charging handle in part of the way.

### WARNING

Do not exchange or switch bolt assemblies from one M4 or M4A1 to another.

- k. Slide in the bolt carrier group.
  - l. Push in the charging handle and the bolt carrier group together.
  - m. Join the upper and lower receivers.
  - n. Engage the receiver pivot pin.
  - o. Close the upper and lower receiver groups. Push in the takedown pin.
  - p. Replace the handguards.
  - q. Replace the sling.
7. Perform a function check on the M4 or M4A1 carbine to determine correct functioning.
  8. Maintain the M16/M4 magazine and ammunition.
    - a. Maintain magazine.

**Performance Steps**

- (1) Disassemble the magazine.
    - Insert the nose of a cartridge into the hole in the base of the magazine and raise the rear of the magazine until the indentation on the base is clear of the magazine.
    - Slide the base forward until free of the tabs.
    - Remove the magazine spring and follower (do not separate).
  - (2) Clean all parts using a rag soaked with CLP. Dry all parts.
  - (3) Inspect parts for damage such as dents and corrosion. If any damage is found, turn in to maintenance.
  - (4) Lubricate the magazine. Lightly lube the spring only.
  - (5) Assemble the magazine.
    - Insert the follower and spring in the magazine tube and jiggle the spring to seat them in the magazine.
    - Slide the base under all four tabs until it is fully seated. Make sure the printing is on the outside.
- b. Maintain the ammunition.**
- (1) Clean ammunition with a clean dry rag.
  - (2) Inspect for and turn in any ammunition with the following defects: corrosion, dented cartridges, cartridges with loose bullets, and cartridges with the bullet pushed in.

**Evaluation Preparation:** *Setup:* Have Soldiers use their own weapons and magazines. Provide swabs; cleaner, lubricant, preservative (CLP); pipe cleaners; lubricating oil; and rifle bore cleaner (the Soldier should not select rifle bore cleaner for use). Also provide several rounds of dummy ammunition if available.

*Brief Soldier:* Tell the Soldier to clean, inspect, and lubricate the weapon and magazine following normal safety practices.

Performance Measures	GO	NO GO
1. Cleared the carbine.	___	___
2. Disassembled the carbine.	___	___
3. Cleaned the weapon using the correct materials.	___	___
4. Inspected for unserviceable parts.	___	___
5. Assembled the carbine.	___	___
6. Performed function check.	___	___
7. Disassembled the magazine.	___	___
8. Cleaned the magazine.	___	___
9. Assembled the magazine	___	___
10. Cleaned the ammunition.	___	___

**Evaluation Guidance:** Refer to chapter 1, paragraph 1-9e, (1) and (2).



## References

### Required:

Related: TM 9-1005-319-10

---

## 071-100-0005

### Perform a Function Check on an M4 or M4A1 Carbine

**Conditions:** Given an M4 or M4A1 carbine that you must confirm is operable.

**Standards:** Perform a function check and ensure that the carbine operates properly with the selector switch in each position.

---

#### Performance Steps

---

1. Check to ensure carbine is clear and the selector lever is on SAFE.
  2. Check M4 or M4A1 carbine with selector lever in the SAFE position.
    - a. Pull the charging handle to the rear and release it.
    - b. Place the selector lever in the SAFE position.
    - c. Squeeze the trigger (the hammer should not fall).
    - d. Stop the function check if the carbine fails to function properly. Turn in malfunctioning carbine to unit armorer.
  3. Check M4 or M4A1 carbine with selector lever in the SEMI position.
    - a. Place the selector lever in the SEMI position.
    - b. Squeeze the trigger, holding it to the rear (the hammer should fall).
    - c. Continue to hold the trigger to the rear while pulling the charging handle to the rear and releasing the charging handle.
    - d. Release the trigger with a slow, smooth motion until the trigger is fully forward (the hammer should not fall).
    - e. Squeeze the trigger (the hammer should fall).
    - f. Stop the function check if the carbine fails to function properly. Turn in malfunctioning carbine to unit armorer.
  4. Check M4A1 carbine with selector lever in the AUTO position.
    - a. Place the selector lever in the AUTO position.
    - b. Pull the charging handle to the rear and release it.
    - c. Squeeze the trigger; the hammer should fall.
    - d. Hold the trigger to the rear and cock the weapon.
    - e. Fully release the trigger; squeeze it to the rear again; and the hammer should not fall.
-

## Performance Steps

- f. Stop the function check if the carbine fails to function properly. Turn in malfunctioning carbine to unit armorer.
5. Check M4 carbine with selector lever in the BURST position.
    - a. Place the selector lever in the BURST position.
    - b. Pull the charging handle to the rear and release it.
    - c. Squeeze the trigger and hold it to the rear; the hammer should fall.
    - d. Continue to hold the trigger to the rear: pull the charging handle to the rear and release it three times.
    - e. Release the trigger.

**Evaluation Preparation:** *Setup:* Have Soldiers use their assigned carbines and magazines.

*Brief Soldier:* Tell the Soldier to perform a function check and to tell the evaluator if the carbine malfunctions.

Performance Measures	GO	NO GO
1. Checked an M4 or M4A1 carbine with the selector lever in the SAFE position; verified the hammer did not fall.	___	___
2. Checked an M4 or M4A1 carbine with the selector lever in the SEMI position; verified the hammer fell.	___	___
<i>Note:</i> Perform either step 3 or 4, as appropriate.		
3. Checked an M4A1 carbine with the selector lever in the AUTO position; verified the hammer did not fall.	___	___
4. Checked an M4 carbine with the selector lever in the BURST position; verified the hammer fell.	___	___
5. Stopped the function check any time the carbine did not function properly and notified the evaluator.	___	___

**Evaluation Guidance:** Refer to chapter 1, paragraph 1-9e, (1) and (2).

### References

#### Required:

**Related:** TM 9-1005-319-10

## 071-100-0006

### Load an M4 or M4A1 Carbine

**Conditions:** Given an M4 or M4A1 carbine with magazines loaded with 5.56-mm ammunition.

**Standards:** Load an M4A1 carbine for semiautomatic and automatic fire or load an M4 carbine for semiautomatic and burst fire. In either case, ensure that a round is chambered and the selector is returned to the SAFE position.

## Performance Steps

1. Load the M4 or M4A1 for semiautomatic fire and the M4A1 for automatic fire.
  - a. Point the carbine muzzle in a safe direction.
  - b. Cock the carbine (this also opens the bolt).
  - c. Place the selector lever on SAFE.
  - d. Open the bolt and check the chamber to ensure it is clear.
  - e. Insert the magazine, pushing it upward until the magazine catch engages the magazine.
  - f. Tap upward on the bottom of the magazine to ensure that it is seated.
  - g. Chamber a round.
    - (1) With the bolt open—
      - (a) Depress the upper portion of the bolt catch to release the bolt.
      - (b) Tap the forward assist to ensure that the bolt is fully forward and locked.

### **WARNING**

The carbine is now loaded. Ensure that it is pointed in a safe direction.

- (2) With the bolt closed—
    - (a) Pull the charging handle to the rear as far as it will go.
    - (b) Release the charging handle. Do not ride it. Let it return on its own.
    - (c) Tap the forward assist to ensure the bolt is fully forward and locked.
  - h. Place the selector lever on the desired mode of fire.
  - i. If the weapon is not to be fired immediately, place selector lever on SAFE and close the ejection port cover.
2. Load the M4 carbine for burst fire.
  - a. Ensure that the weapon is clear and the bolt is forward.
  - b. Point the carbine muzzle in a safe direction.
  - c. Place the selector lever on BURST.
  - d. Squeeze the trigger and hold it in the rear position. Then—
    - (1) Pull the charging handle to the rear and release it three times.
    - (2) Pull the charging handle to the rear one more time; hold it to the rear.
    - (3) Let go of the trigger.

### Performance Steps

- e. Push in on the bottom portion of the bolt catch, locking the bolt in the rear position.
- f. Slide the charging handle all the way forward.
- g. Place the selector lever on SAFE.
- h. Insert a loaded magazine; tap upward on the bottom of the magazine to ensure that it is seated.
- i. Push on the upper portion of the bolt catch to allow the bolt to go forward and chamber a round.
- j. Place the selector lever on BURST to fire 3-round bursts each time the trigger is squeezed.
- k. If the weapon is not to be fired immediately, place the selector lever on SAFE and close the ejection port cover.

**Evaluation Preparation:** *Setup:* Have Soldiers use their assigned weapons and magazines. Provide blank or dummy ammunition.

*Brief Soldier:* Tell the Soldier to load the carbine.

Performance Measures	GO	NO GO
1. Loaded the M4 or M4A1 for semiautomatic fire and the M4A1 for automatic fire.	___	___
2. Loaded the M4 carbine for burst fire.	___	___

**Evaluation Guidance:** Refer to chapter 1, paragraph 1-9e, (1) and (2).

### References

**Required:**

**Related:** TM 9-1005-319-10

## 071-100-0007

### Unload an M4 or M4A1 Carbine

**Conditions:** Given a loaded M4 or M4A1 carbine.

**Standards:** Remove the magazine and all ammunition from the weapon. Ensure that the rifle is clear and the selector lever is on SAFE.

### Performance Steps

1. Remove the magazine.
  - a. Point the rifle muzzle in a safe direction.
  - b. Place the selector lever on SAFE (if the weapon is not cocked, you cannot place the selector lever on SAFE).
  - c. Remove the magazine from the rifle.

### Performance Steps

2. Remove ammunition.
  - a. Lock the bolt open and return the charging handle forward.
  - b. Check the receiver and chamber for ammunition. Remove any ammunition present.
  - c. Press the bottom of the bolt catch, allowing the bolt to go forward.
  - d. Place the selector lever on SAFE.

**Evaluation Preparation:** *Setup:* At a test site, provide an M4 or M4A1 carbine loaded with dummy ammunition.

*Brief Soldier:* Tell the Soldier to unload the carbine.

Performance Measures	GO	NO GO
1. Removed the magazine.	___	___
2. Removed ammunition.	___	___

**Evaluation Guidance:** Refer to chapter 1, paragraph 1-9e, (1) and (2).

### References

#### Required:

**Related:** TM 9-1005-319-10

## 071-100-0008

### Correct Malfunctions of an M4 or M4A1 Carbine

**Conditions:** Given a loaded M4 or M4A1 carbine that has stopped firing and a small-arms accessory case with the following cleaning materials: clean wiping rags; bore brush; chamber brush; tooth brush; cleaning rod; small arms swabs; pipe cleaners; cleaner, lubricant, preservative (CLP); and lubricating oil arctic weather (LAW).

**Standards:** Eliminate the stoppage so that firing resumes.

### Performance Steps

1. Perform immediate action.

**Note:** If your carbine malfunctions, remember S-P-O-R-T-S. This key word will help you remember these actions in sequence: slap, pull, observe, release, tap, shoot.

- a. Slap upward on the magazine to make sure it is properly seated.
- b. Pull the charging handle all the way back.
- c. Observe the ejection of the case or cartridge. Look into the chamber and check for obstructions.
- d. Release the charging handle to feed a new round in the chamber. Do not ride the charging handle.

## Performance Steps

- e. Tap the forward assist.
  - f. Shoot. If the carbine still does not fire, inspect it to determine the cause of the stoppage or malfunction, and take appropriate remedial action.
2. Perform remedial action. If the carbine still fails to fire after performing steps 1a through 1f, check the chamber for a jammed cartridge case.
- a. If a cartridge case is in the chamber, tap it out with a cleaning rod.
  - b. Attempt to fire. If the carbine still fails to fire, perform procedures to correct a mechanical malfunction.
  - c. Correct a mechanical malfunction.
    - (1) Clear the carbine.
    - (2) Disassemble the carbine.
    - (3) Inspect for dirty, corroded, missing, or broken parts.
    - (4) Clean dirty or corroded parts.
    - (5) Replace missing or broken parts.
    - (6) Assemble the carbine.
    - (7) Perform a function check.
    - (8) Load and fire the carbine.

**Evaluation Preparation:** *Setup:* Provide an M4 or M4A1 carbine loaded with dummy ammunition.

*Brief Soldier:* Tell the Soldier that the rifle has stopped firing. Tell the Soldier that the weapon is cool and that he/she is to perform the immediate or remedial actions on the rifle. All steps must be performed in the proper sequence.

Performance Measures	GO	NO GO
1. Performed immediate action.	___	___
2. Performed remedial action.	___	___

**Evaluation Guidance:** Refer to chapter 1, paragraph 1-9e, (1) and (2).

### References

#### Required:

**Related:** TM 9-1005-319-10

**SUBJECT AREA 17: SIGHTS, NIGHT, DAY, AIMING DEVICES**

## 071-008-0007

### Engage Targets with an M16-Series Rifle Using an AN/PAS-13-Series Thermal Weapon Sight

**Conditions:** Given an M16-series rifle with a mounted and zeroed AN/PAS-13 series thermal weapon sight (TWS), loaded magazines with 5.56-mm ammunition, threat targets, and a requirement to engage such targets.

**Standards:** Detect and determine the range to targets; fire the M16-series rifle to engage targets in the assigned sector of fire; and apply correct marksmanship fundamentals and target engagement techniques so that each target is hit or suppressed.

---

**Performance Steps**

---

1. Place TWS into operation.
  2. Assume an appropriate firing position based on the situation. The firing position should protect you from enemy fire and observation, yet allow you to place effective fire on targets in your sector of fire.
    - a. Foxhole. Advantages: best when available. Disadvantages: no overhead cover.
    - b. Prone. Advantages: steady, easy to assume, low silhouette, and easily adapted to use of cover and support. Disadvantages: effectiveness can be limited by terrain and vegetation irregularities.
    - c. Prone supported. Advantages: steadier than prone; other advantages the same as prone. Disadvantages: same as prone.
    - d. Kneeling. Advantages: used when firing from behind something; used on ground that is level or gently sloping upward. Disadvantage: exposed to small arms fire.
    - e. Kneeling supported. Advantages: steadier than kneeling; other advantages the same as kneeling. Disadvantages: exposure to small arms fire.
    - f. Standing. Advantages: used in assault to surprise targets or when other positions are not appropriate. Disadvantages: unstable and allows more exposure to small arms fire.
  3. Identify targets in your designated sector of fire.
  4. Load the weapon.
  5. Acquire targets using the TWS reticule. Use the small dots shown in a horizontal row to the right of the reticule center as the aiming points for M16-series rifles.
    - a. Personnel: Place the target on the horizontal line and match its height with one of the vertical lines. Measurement is made from the horizontal line to the top (or bottom) of each vertical line for the range indicated.
    - b. Tank: When viewed from the side, place the left edge of the tank at the left side of the horizontal line. Read the range to the tank from the scale at the right edge of the tank. When viewed from the front or rear, use one-half of the indicated range value (since the width of the tank is approximately one-half of the length of the tank).
  6. Fire on the target(s) until they are destroyed or until you receive an order to cease fire.
-

**Evaluation Preparation:** *Setup:* Evaluate this task on a live-fire range. Provide the Soldier with the equipment and materials in **the** task conditions statement.

*Brief Soldier:* Brief the Soldier on range safety according to the installation standing operating procedures (SOPs). Tell the Soldier to assume the prone supported or supported fighting position. Tell the Soldier you are evaluating his/her ability to place effective fire on targets using the M16-series rifle equipped with the AN/PAS-13 thermal weapon sight.

Performance Measures	GO	NO GO
1. Placed TWS into operation.	___	___
2. Assumed an appropriate firing position based on the situation.	___	___
3. Identified targets in the designated sector of fire.	___	___
4. Loaded the weapon.	___	___
5. Acquired targets using TWS reticle.	___	___
6. Fired on target(s) until they were destroyed or until the order to cease fire was received.	___	___

**Evaluation Guidance:** Refer to chapter 1, paragraph 1-9e, (1) and (2).

**References**

**Required:**

**Related:** FM 21-75 and TM 11-5855-309-12&P

---

## 071-008-0011

### Engage Targets with an M16-Series Rifle Using an AN/PAQ-4-Series Aiming Light

**Conditions:** Given an M16-series rifle with a mounted and zeroed AN/PAQ-4-series aiming light, magazines, ammunition, individual combat equipment, and stationary or moving targets (personnel) at engageable ranges.

**Standards:** Detect and determined range to targets. Fire the weapon and engaged the targets in the assigned sector of fire. Apply correct marksmanship fundamentals and target engagement techniques to hit or suppress the target or force the enemy to move.

#### Performance Steps

1. Assume an appropriate firing position based on the situation. The firing position should protect you from enemy fire and observation, yet allow you to place effective fire on targets in your sector of fire.
  - a. Foxhole. Advantages: best when available. Disadvantages: no overhead cover.
  - b. Prone. Advantages: steady, easy to assume, low silhouette, and easily adapted to use of cover and support. Disadvantages: terrain and vegetation irregularities can limit effectiveness.



## Performance Steps

- c. Prone supported. Advantages: steadier than prone, other advantages the same as prone. Disadvantages: same as prone.
  - d. Kneeling. Advantages: used when firing from behind something, used on ground that is level or gently sloping upward. Disadvantages: exposed to small arms fire.
  - e. Kneeling supported. Advantages: steadier than kneeling, other advantages the same as kneeling. Disadvantages: exposure to small arms fire.
  - f. Standing. Advantages: used in assault to surprise targets or when other positions are not appropriate. Disadvantages: exposure to small arms fire.
2. Identify targets in your designated sector of fire.
  3. Determine the range to a target.
  4. Load and fire on targets using appropriate engagement techniques.
    - a. Load the weapon.
    - b. Use the appropriate aiming technique.

*Note:* When used with the M16A1/A2, the IAL is activated in the #4 ON MOMENTARY position only.

- (1) Press the ON/OFF switch against the weapon handguard to activate the IAL. The IAL will project an infrared pulsing spot toward the target.
  - (2) Engage the target when the IAL is on the desired point of impact.
  - (3) Engage a stationary target using reference points or sighting points.
  - (4) Engage a target moving toward you the same as you would a stationary target.
  - (5) Engage a target moving laterally using the new single-lead technique by placing the trailing edge of the front sight post at the center of the target. This method causes the lead to increase automatically as the range increases.
  - (6) Engage multiple targets by first firing at the one presenting the greatest danger (usually the closest) and then rapidly proceeding to the next target.
- c. Use the quick-fire technique when you do not have time to aim properly. Use this technique on targets within 30 meters of your location. (This technique works best in urban terrain or heavy bush.)
    - (1) Use the standing position.
    - (2) Use the raised stockwell, looking 2 or 3 inches above the sights on a plane that is level with the barrel.
    - (3) Look at the target and not at the sights.
  - d. Fire on the targets until you destroy them or until you receive an order to cease fire.

**Evaluation Preparation:** *Setup:* At a live-fire range, provide the equipment and materials listed in the task conditions statement. Turn off the sight after the evaluation.

*Brief Soldier:* Tell the Soldier to engage all targets in his/her assigned sector.

Performance Measures	GO	NO GO
1. Assumed an appropriate firing position based on the situation.	___	___
2. Identified targets in your designated sector of fire.	___	___
3. Determined the range to a target.	___	___
4. Loaded and fired on targets using the appropriate engagement techniques.	___	___

**Evaluation Guidance:** Refer to chapter 1, paragraph 1-9e, (1) and (2).

**References**

**Required:**

**Related:** FM 23-9 and TM 11-5855-301-12&P

## 071-010-0002

### Mount a Night Vision Sight, AN/PVS-4, on an M249 Machine Gun

**Conditions:** Given a cleared M249 machine gun; an AN/PVS-4 mounting bracket assembly for the M249 machine gun; a night vision sight, AN/PVS-4; and a requirement to mount the night vision sight, AN/PVS-4, on the M249 machine gun.

**Standards:** Attach and secure the mounting bracket assembly and night vision sight, AN/PVS-4, to the M249 machine gun.

<b>Performance Steps</b>
--------------------------

**CAUTION**

When mounting an AN/PVS-4 night sight on a mounting bracket, align the mounting screw hole on the sight so it fits flush against the mounting bracket.

1. Install the mounting bracket assembly (figure 071-010-0002-1).

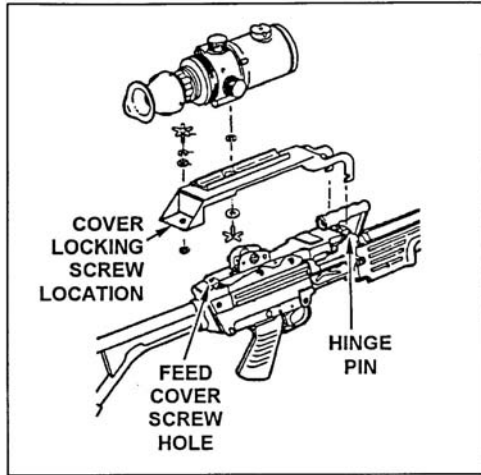

Figure 071-010-0002-1. Installation of mounting bracket assembly

- a. Hook the mounting bracket feet around the feed cover pin and position the bracket on top of the weapon.
  - b. Turn the mounting bracket locking screw into the feed cover screw hole to secure the bracket.
2. Install the sight on the mounting bracket on the weapon.
  - a. Place the sight on the mounting bracket. Align the mounting screw hole on the sight flush against the mounting bracket locking screw.
  - b. Tighten the sight mounting bracket locking screw to secure the night sight to the bracket.

**Evaluation Preparation:** *Setup:* At the test site, provide the Soldier with all the equipment given in the task conditions statement.

*Brief Soldier:* Tell the Soldier that he/she must mount night vision sight, AN/PVS-4, on the M249 machine gun.

Performance Measures	GO	NO GO
1. Installed the mounting bracket on the weapon.	___	___
2. Installed the nightsight on the mounting bracket.	___	___

**Evaluation Guidance:** Refer to chapter 1, paragraph 1-9e, (1) and (2).

**References**

**Required:**

**Related:** FM 3-22.68 and TM 11-5855-213-10

# 071-101-0003

## Dismount a Night Vision Sight, AN/PVS-4, from an M249 Machine Gun

**Conditions:** Given an M249 machine gun with a mounted night vision sight, AN/PVS-4; carrying case for the AN/PVS-4; and a requirement to remove the AN/PVS-4 from the M249 machine gun.

**Standards:** Remove the night vision sight, AN/PVS-4, and mounting bracket assembly from the M249 machine without damage to the equipment. Stow the AN/PVS-4 in the carrying bag.

### Performance Steps

1. Remove the AN/PVS-4 night vision sight from the mounting bracket assembly.
  - a. Loosen the sight mounting screw by turning it counterclockwise until it is free of the sight.
  - b. Remove the sight from the mounting bracket.
2. Remove the mounting bracket assembly.
  - a. Loosen the mounting bracket screw until it is free of the feed cover mechanism.
  - b. Lift the mounting bracket assembly from the M249.
3. Stow the AN/PVS-4 night vision sight and mounting bracket assembly.
  - a. Remove the batteries from the sight.
  - b. Place the sight and bracket into the carrying case.

**Evaluation Preparation:** *Setup:* At the test site, provide the Soldier with all the equipment given in the task conditions statement.

*Brief Soldier:* Tell the Soldier to remove and stow the night vision sight, AN/PVS-4, and mounting bracket assembly without damage to the equipment.

Performance Measures	GO	NO GO
1. Removed the AN/PVS-4 from the mounting bracket assembly.	___	___
2. Removed the mounting bracket assembly.	___	___
3. Stowed the night vision sight, AN/PVS-4, and mounting bracket assembly in the carrying bag.	___	___

**Evaluation Guidance:** Refer to chapter 1, paragraph 1-9e, (1) and (2).

### References

#### Required:

**Related:** FM 3-22.68 and TM 11-5855-213-10

---

## 071-010-0007

### Engage Targets with an M249 Machine Gun Using a Night Vision Sight, AN/PVS-4

**Conditions:** During darkness, given an M249 machine gun equipped with a mounted night vision sight, AN/PVS-4, that has been zeroed to the gun; linked 5.56-mm ammunition; engageable targets in the assigned sector of fire; and a requirement to engage the targets.

**Standards:** Fire the M249 machine gun to effectively engage targets in the assigned sector of fire. Apply correct M249 machine gun target engagement techniques using the night vision sight, AN/PVS-4. Engage and hit each target.

#### Performance Steps

1. Place the night vision sight, AN/PVS-4, into operation.
2. Assume a bipod-supported prone position or a bipod-supported fighting position. (These are the best positions for delivering effective M249 fire on targets when using the AN/PVS-4).
3. Detect and estimate the range to the target.
4. Acquire a good sight picture. Adjust the weapon to place the correct aiming point (based on range to target) on the center base of the target.
5. Use the center point between the two horizontal lines in the middle of the reticle as the aiming point for ranges 0 to 300 meters.

**Note:** Aiming points for ranges from 300 to 800 meters appear as small dots in a vertical line down through the center of the reticle.

- a. Use aiming points 4 and 6 (400 and 600 meters) to fire at 400- and 600-meter targets, respectively.
  - b. Use aiming point 8 (800 meters) to fire at 700-meter targets.
  - c. Use aiming point 10 (1,000 meters) to fire at 800-meter targets.
6. Fire the weapon in three-round bursts at the rate of fire appropriate for the size of the target. Use correct trigger manipulation techniques (pull the trigger straight to the rear and release it).
  7. Apply the correct engagement technique based on target types.
    - a. Fixed fire. This is fire delivered against a point target (against one aiming point) when the depth and width of the beaten zone covers the target completely.
    - b. Traversing fire. This is fire distributed in width by successive changes in direction by moving the muzzle of the weapon to the left or right to distribute fire laterally. To make minor changes in direction, shift the shoulders to the right or left to locate successive aiming points throughout the width of the target area. For major changes, move the elbows and align the body to remain directly behind the gun.

## Performance Steps

**c.** Searching fire. This is fire distributed in width by successive changes in elevation through moving the muzzle of the weapon up or down to distribute fire in depth and choosing successive aiming points throughout the target area. To make changes in elevation, move elbows closer together (this lowers the muzzle) or farther apart (this raises the muzzle).

**d.** Traversing and searching fire. This is fire distributed in width and depth by successive changes in direction and elevation. Combining traversing and searching fire provides good target coverage. Make adjustments the same way you would for traversing or searching fire by moving the muzzle of the weapon to the left or right to distribute fire laterally. To make minor changes in direction, shift the shoulders to the right or left and choose successive aiming points throughout the width of the target area. For major changes, move the elbows and align the body to remain directly behind the gun.

**8.** Use observation of fire and adjustment of fire to place effective fire on the target.

**a.** Observation of fire. Observe bursts of fire by noting the strike of the rounds in the target area or by observing tracers in flight.

**b.** Adjustment of fire. Use the adjusted aiming point method to quickly adjust fires without adjusting the sight. If the initial burst misses the target, rapidly select a new aiming point the same distance from the center of impact of the initial burst, but in the opposite direction. Fire a second burst.

**9.** Apply fire correctly to engage specific targets.

**a.** Point target. Engage point targets with fixed fire.

**b.** Area target. Initially aim at the midpoint of the target area. Traverse and search to either flank, then back to the opposite flank.

**c.** Linear target. Initially aim at the midpoint of the target. Traverse fire from one flank to the other to cover the entire target.

**d.** Deep target. Initially aim at the midpoint of the target, unless another portion of the target is more critical or presents a greater threat. Search down to an aiming point in front of the near end, then back up to an aiming point beyond the far end.

**e.** Linear target with depth. Initially aim at the midpoint of the target, unless another portion of the target is more critical or presents a greater threat. Traverse and search to the flank closest to your position, then back to the other flank to cover the entire target.

**f.** Moving target. To hit a moving target, estimate the speed of the target and the lead required to hit it. Fire, then track the target as it moves. Adjust the lead by observing tracers and bullet strikes.

**Evaluation Preparation:** *Setup:* Evaluate this task on a live-fire range. Have the Soldier fire table III, tasks 2 through 6 (FM 23-14, page 5-49). Evaluate the Soldier's ability to use correct engagement techniques to engage specific targets. Provide the Soldier with equipment and materials required to fire table III, tasks 2 through 6.

*Brief Soldier:* Brief the Soldier on range safety, according to the installation standing operating procedure (SOP). Tell the Soldier to assume the bipod-supported prone position or the bipod-supported fighting position. Tell him/her that you are evaluating his/her ability to place effective fire on targets using the AN/PVS-4-equipped M249 machine gun.

Performance Measures	GO	NO GO
1. Placed a night vision sight, AN/PVS-4, into operation.	___	___
2. Assumed a correct bipod-supported prone position or bipod-supported fighting position.	___	___
3. Detected and estimated the range to the target.	___	___
4. Placed effective fire on targets in three-round bursts at a rate of fire appropriate for the size of the target.	___	___
5. Applied correct engagement techniques based on the types of targets.	___	___
6. Applied fire correctly to engage specific targets.	___	___

**Evaluation Guidance:** Refer to chapter 1, paragraph 1-9e, (1) and (2).

#### References

#### Required:

**Related:** FM 23-14

## 071-010-0008

### Mount an AN/PAS-13 Thermal Weapon Sight on an M249 Machine Gun

**Conditions:** Given a cleared M249 machine gun, a night vision sight, AN/PAS-13 thermal weapon sight (TWS), and a requirement to mount the night vision sight, AN/PAS-13 on the M249 machine gun.

**Standards:** Attach and secure the night vision sight, AN/PAS-13 to the M249 machine gun.

#### Performance Steps

#### WARNING

Ensure that the weapon is not loaded and the safety is on before installing the sight on the weapon. A loaded weapon may accidentally discharge, causing injury or death.

1. Install the TWS hinge pin.
  - a. Remove the retaining clip from the TWS hinge pin on M249 bracket and remove the TWS hinge pin.

## Performance Steps

- b. Remove the retaining clip from the M249 hinge pin.
- c. Squeeze the feed tray cover latches and swing the feed tray cover completely forward.
- d. Hold the feed tray cover in the fully raised position. Use the TWS hinge pin to push on the M249 hinge pin, pushing right to left. As the M249 hinge pin is being pushed out, push in the TWS hinge pin.
- e. Adjust the position of the TWS hinge pin so the groove in the TWS hinge pin is aligned with the slot in the feed tray cover. Install the retaining clip.
- f. Squeeze the feed tray cover latches and lower the feed tray cover until closed.
- g. Place the M249 hinge pin in the hole of the bracket. Align the groove in the M249 hinge pin with the hole in the bracket and install the retaining clip.

**Note:** Remove the shipping plug from the threaded hole of the feed tray cover.

2. Secure the mounting bracket to the cover.
  - a. Loosen the thumbscrews.
  - b. Place the grooves of bracket over the ends of the TWS hinge pin and lower the bracket on the feed tray cover of the M249.
  - c. Install the bolt of the bracket into the threaded hole of the feed tray cover. Hand tighten the thumbwheel and thumbscrews.
  - d. Lower the carrying handle.

### CAUTION

When raising or lowering the feed tray cover with the TWS installed, avoid slamming the TWS into the heat shield or slamming the feed tray cover closed.

3. Install the TWS on rail.
  - a. Loosen the knob on the mount.
  - b. Select the slot on the rail for mounting. Any slot may be used as long as the mount does not hang over the edge of the rail.
  - c. Place the bar of the mount in the slot of the rail and hand tighten the knob on the mount until a clicking noise is heard.

**Evaluation Preparation:** *Setup:* At the test site, provide the Soldier with all the equipment given in the task condition statement.

*Brief Soldier:* Tell the Soldier that he/she must mount the thermal weapon sight, AN/PAS-13 on the M249 machine gun.

Performance Measures	GO	NO GO
1. Checked to ensure the weapon was clear.	___	___
2. Installed the sight on the M249 machine gun.	___	___



**Evaluation Guidance:** Refer to chapter 1, paragraph 1-9e, (1) and (2).

**References**

**Required:**

**Related:** TM 11-5855-302-12&P and TM 11-5855-309-12&P

---

## **071-010-0009**

### **Dismount an AN/PAS-13 Thermal Weapon Sight from an M249 Machine Gun**

**Conditions:** Given a cleared M249 machine gun with a mounted AN/PAS-13 thermal weapon sight (TWS) and TWS carrying case with basic issue items. The TWS brightness control switch is at the OFF position, and the battery is installed.

**Standards:** Remove the TWS from the M249 machine gun without damage to the equipment, and stow the TWS and battery correctly in the carrying case.

#### **Performance Steps**

#### **WARNING**

Ensure that the weapon is not loaded and that the safety switch is on before removing the TWS bracket from the weapon. A loaded weapon may accidentally discharge, causing injury or death.

#### **CAUTION**

Avoid handling or carrying the TWS by the eyecup, objective lens cover, or the battery cover latch. Any one of these items may detach from the system, causing it to drop.

1. Check to ensure the M249 is clear and the safety is on.
2. Remove the TWS from the M249.
  - a. Secure the TWS with one hand to prevent it from falling, and loosen the knob on mount by turning counterclockwise.
  - b. Remove the TWS from the rail.
3. Remove the M249 bracket.
  - a. Unscrew the thumbwheel from the M249.
  - b. Loosen the thumbscrews on the bracket and lift the bracket off of the M249.
4. Install the M249 hinge pin.
  - a. Remove the retaining clip from the M249 hinge pin on the bracket and remove the M249 hinge pin.
  - b. Remove the retaining clip from the TWS hinge pin.
  - c. Squeeze the feed tray cover latches and swing the feed tray cover completely forward.

## Performance Steps

- d. Hold the feed tray cover in the fully raised position. Use the M249 hinge pin to push on the TWS hinge pin, pushing right to left. As the TWS hinge pin is being pushed out, push in the M249 hinge pin.
  - e. Adjust the position of M249 hinge pin so the groove in the hinge pin is aligned with the slot in the feed tray cover. Install the retaining pin.
  - f. Squeeze the feed tray cover latches and lower the feed tray cover until closed.
  - g. Place the TWS hinge pin in the hole of the bracket. Align the groove in the TWS hinge pin with the hole in the bracket and install the retaining clip.
5. Stow the TWS and component parts.
- a. Ensure the brightness knob is at the OFF position.
  - b. Ensure the objective lens cover is closed.
  - c. Remove the battery; close and secure battery door.
  - d. Stow the TWS and battery in their proper compartments in the carrying case.
  - e. Place the weapon bracket in the pouch of the carrying case.
  - f. Close and zip the carrying case.

**Evaluation Preparation:** *Setup:* At the test sight, provide the Soldier with all the equipment given in the task conditions statement.

*Brief Soldier:* Tell the Soldier to remove the thermal weapon sight, AN/PAS-13 from the M249 machine gun.

Performance Measures	GO	NO GO
1. Ensured that the weapon was clear.	___	___
2. Removed the TWS from the weapon.	___	___
3. Stowed the TWS and components.	___	___

**Evaluation Guidance:** Refer to chapter 1, paragraph 1-9e, (1) and (2).

### References

### Required:

**Related:** TM 11-5855-301-12&P and TM 11-5855-309-12&P

## 071-010-0011

### Engage Targets with an M249 Machine Gun Using an AN/PAS-13 Thermal Weapon Sight

**Conditions:** Given an M249 machine gun with a mounted and zeroed AN/PAS-13 thermal weapon sight (TWS), linked 5.56-mm ammunition, threat targets, and a requirement to engage such targets.

**Standards:** Detect and determine the range to targets. Fire the M249 machine gun and engage targets in the assigned sector of fire. Apply correct marksmanship fundamentals and target engagement techniques so that each target is hit or suppressed.

**Performance Steps**

1. Place the TWS into operation.
2. Assume an appropriate firing position based on the situation. The firing position should protect you from enemy fire and observation, yet allow you to place effective fire on targets in your sector of fire.
  - a. Prone position, bipod-supported. Advantages: steady, easy to assume, low silhouette, and easily adapted to use of cover and support. Disadvantages: effectiveness can be limited by terrain and vegetation irregularities.
  - b. Fighting position, bipod-supported. Advantages: best when available.
3. Identify targets in your designated sector of fire.
4. Load the weapon.
5. Acquire targets using the TWS reticle.
  - a. Personnel: Place the target on the horizontal line and match its height with one of the vertical lines. Measurement is made from the horizontal line to the top (or bottom) of each vertical line for the range indicated. The vertical line of a crosshair reflects the height of a 5-foot man at the specified range.
  - b. Tank: When viewed from the side, place the left edge of a tank at the left side of the horizontal line. Read the range to the tank from the scale at the right edge of the tank. When viewed from the front or rear, use one-half of the indicated range value (since width of the tank is approximately one-half of the length of the tank). The horizontal line of a cross hair reflects the width of a 10-foot tank at the specified range.
  - c. The firing aiming point of each cross hair is the point of intersection of the vertical and horizontal lines.
6. Fire on target(s) until destroyed or until you receive an order to cease fire.

**Evaluation Preparation:** *Setup:* Evaluate this task on a live-fire range. Evaluate the Soldier's ability to use correct engagement techniques to engage specific types of targets. Provide the Soldier with the equipment and materials in the task conditions statement.

*Brief Soldier:* Brief the Soldier on range safety according to the installation standing operating procedure (SOP). Tell the Soldier to assume the bipod-supported prone position or the bipod-supported fighting position. Tell the Soldier you are evaluating his/her ability to place effective fire on targets using the AN/PAS-13-equipped M249 machine gun.

Performance Measures	GO	NO GO
1. Placed the TWS into operation.	___	___

Performance Measures	GO	NO GO
2. Assumed a suitable firing position.	___	___
3. Acquired targets.	___	___
4. Engaged targets using the correct M249 firing techniques.	___	___

**Evaluation Guidance:** Refer to chapter 1, paragraph 1-9e, (1) and (2).

### References

#### Required:

**Related:** FM 3-22.68, TM 11-5855-302-12&P, and TM 11-5855-309-12&P

## 071-022-0008

### Mount a Night Vision Sight, AN/TVS-5, on a Caliber .50 M2 Machine Gun

**Conditions:** In a combat environment, given a mounted caliber .50 M2 machine gun; an operational night vision sight, AN/TVS-5, with all required accessories in a storage container; and a mounting bracket.

**Standards:** Secure the mounting bracket to the receiver group so that the cover closes. Mount and secure the night vision sight, AN/TVS-5, with the lever screw.

#### Performance Steps

1. Remove the sight from its storage container.
  2. Conduct an inspection of the AN/TVS-5 and its accessories and perform operator maintenance as required.
  3. Ensure that the machine gun's rear sight is in the down position.
  4. Release the catch on the left side of the cartridge cover and raise the machine gun's cover group to the upright position.
  5. Position the mounting bracket over the breech of the machine gun and slide it rearward until it stops.
  6. Push the three locking cams to the rear to secure the bracket.
- Note:* The side cam should be pushed first, then the two on top.
7. Close the cartridge cover.
  8. Install the sight on the mounting bracket assembly by aligning the scribe lines on the sight with the scribe lines on the bracket.
  9. Place the sight in the groove at the top of the bracket.
  10. Tighten the lever screw to secure the sight to the bracket.

**Evaluation Preparation:** *Setup:* At the test site, provide the Soldier with all the equipment given in the task conditions statement.

*Brief Soldier:* Tell the Soldier to mount the night vision sight, AN/TVS-5, on the caliber .50 M2 machine gun.

Performance Measures	GO	NO GO
1. Removed the sight from its storage container.	_____	_____
2. Conducted an inspection of the AN/TVS-5 and its accessories and performed operator maintenance as required.	_____	_____
3. Ensured that the machine gun's rear sight was in the down position.	_____	_____
4. Released the catch on the left side of the cartridge cover and raised the machine gun's cover group to the upright position.	_____	_____
5. Positioned the mounting bracket over the breech of the machine gun and slid it rearward until it stopped.	_____	_____
6. Pushed the three locking cams to the rear to secure the bracket.	_____	_____
<i>Note:</i> The side cam should have been pushed first, and then the two on the top.		
7. Closed the cartridge cover.	_____	_____
8. Installed the sight on the mounting bracket assembly by aligning the scribe lines on the sight with the scribe lines on the bracket.	_____	_____
9. Placed the sight in the groove at the top of the bracket.	_____	_____
10. Tightened the lever screw and secured the sight to the bracket.	_____	_____

**Evaluation Guidance:** Refer to chapter 1, paragraph 1-9e, (1) and (2).

**References**

**Required:**

**Related:** FM 3-22.65 and TM 11-5855-214-10

**071-022-0009**

**Dismount a Night Vision Sight, AN/TVS-5, from a Caliber .50 M2 Machine Gun**

**Conditions:** Given a vehicle- or ground-mounted caliber .50 M2 machine gun equipped with a night vision sight, AN/TVS-5; a requirement to remove the night vision sight, AN/TVS-5, from the caliber .50 M2 machine gun; a night vision sight, AN/TVS-5, carrying and storage case; and a requirement to properly stow the AN/TVS-5.

**Standards:** Remove the mounting bracket assembly and the night vision sight, AN/TVS-5, from the caliber .50 M2 machine gun without damage to the equipment, and stow in the carrying and storage case.

## Performance Steps

1. Loosen the lever screw assembly.
2. Remove the sight from the mounting bracket and correctly stow it in the carrying and storage case.
3. Open and raise the cover of the caliber .50 M2 machine gun.
4. Unlock the three locking cams on the mounting bracket.
5. Remove the mounting bracket assembly and correctly stow it in the carrying and storage case.
6. Close the cover of the caliber .50 M2 machine gun.
7. Close and secure the carrying and storage case.

**Evaluation Preparation:** *Setup:* At the test site, provide all the equipment given in the task conditions statement.

*Brief Soldier:* Tell the Soldier to remove the night vision sight, AN/TVS-5, from the caliber .50 M2 machine gun.

Performance Measures	GO	NO GO
1. Loosened the lever screw assembly.	___	___
2. Removed the sight from the mounting bracket and correctly stowed it in the carrying and storage case.	___	___
3. Opened and raised the cover of the caliber .50 M2 machine gun.	___	___
4. Unlocked the three locking cams on the mounting bracket.	___	___
5. Removed the mounting bracket assembly and correctly stowed it in the carrying and storage case.	___	___
6. Closed the cover of the caliber .50 M2 machine gun.	___	___
7. Closed and secured the carrying and storage case.	___	___

**Evaluation Guidance:** Refer to chapter 1, paragraph 1-9e, (1) and (2).

### References

### Required:

**Related:** FM 3-22.65 and TM 11-5855-214-10

## 071-022-0017

### Mount an AN/PAS-13 Thermal Weapon Sight on a Caliber .50 M2 Machine Gun

**Conditions:** Given a cleared caliber .50 M2 machine gun, a AN/PAS-13 thermal weapon sight (TWS), and a requirement to mount the AN/PAS-13 on the caliber .50 M2 machine gun.

**Standards:** Attach and secure the AN/PAS-13 TWS to the caliber .50 M2 machine gun.

**Performance Steps**

**WARNING**

Ensure that the weapon is not loaded and the safety is on before installing the sight to the weapon. A loaded weapon may accidentally discharge, causing injury or death.

1. Mount the M2 bracket on the caliber .50 M2 machine gun.
  - a. Fold the rear sight forward to the storage position.
  - b. Release the cover latch at the side of the cover and fully raise the cover.
  - c. Release the three locking cams on the bracket.
  - d. Place the bracket over the breech of the caliber .50 M2 machine gun.

*Note:* If the bracket sticks before reaching the position, rock the bracket up and down while sliding.

- e. Slide the bracket over the ledge of the caliber .50 M2 machine gun until the inside edge of the bracket touches the front edge of the rear sight base.
  - f. Swing the side locking cam towards the rear of the caliber .50 M2 machine gun.
  - g. Lower the cover until the cover latch engages.
  - h. Loosen the locking knob and swing the range lever to the near position. Hand tighten the knob.
2. Install the TWS on the rail.
  - a. Loosen the knob on the mount.
  - b. Select the slot on the rail for mounting. Any slot may be used as long as the mount does not hang over the edge of the rail.
  - c. Place the bar of the mount in the slot of the rail and hand tighten the knob on the mount until a clicking noise is heard.

**Evaluation Preparation:** *Setup:* At the test site, provide the Soldier with all the equipment given in the task conditions statement.

*Brief Soldier:* Tell the Soldier to mount the AN/PAS-13 TWS on the caliber .50 M2 machine gun.

Performance Measures	GO	NO GO
1. Ensured that the weapon was cleared.	___	___
2. Installed the sight on the caliber .50 M2 machine gun.	___	___

**Evaluation Guidance:** Refer to chapter 1, paragraph 1-9e, (1) and (2).

## References

### Required:

**Related:** TM 11-5855-302-12&P and TM 11-5855-309-12&P

---

## 071-022-0018

### Dismount an AN/PAS-13 Thermal Weapon Sight from a Caliber .50 Machine Gun

**Conditions:** Given a cleared caliber .50 M2 machine gun with a mounted AN/PAS-13 thermal weapon sight (TWS) with the brightness control switch in the OFF position and the battery installed; and a TWS carrying case with basic issue items.

**Standards:** Remove the TWS from the caliber .50 M2 machine gun without damaging the equipment. Stow the TWS and the battery in the correct place in the carrying case.

#### Performance Steps

#### WARNING

Ensure that the weapon is not loaded and the safety is on before removing the bracket from the weapon. A loaded weapon may accidentally discharge, causing injury or death.

#### CAUTION

Avoid handling or carrying the weapon by the eyecup, the objective lens cover, or the battery cover latch. Any one of these items may accidentally detach from the system, causing it to drop.

1. Check to ensure that the caliber .50 M2 machine gun is clear and the safety is on.
2. Remove the TWS from the caliber .50 M2 machine gun.
  - a. Secure the TWS with one hand to prevent it from falling and loosen the knob on the mount by turning counterclockwise.
  - b. Remove the TWS from the rail.
3. Remove the M2 bracket from the caliber .50 M2 machine gun.
  - a. Release the two top locking cams.
  - b. Release the side locking cam.
4. Stow the TWS and component parts.
  - a. Ensure the brightness knob is at the OFF position.
  - b. Ensure the objective lens cover is closed.
  - c. Remove the battery, close and secure battery door.
  - d. Stow the TWS and battery in their proper compartments in the carrying case.



### Performance Steps

- e. Place the weapon bracket in the pouch carrying case.
- f. Close and zip the carrying case.

**Evaluation Preparation:** *Setup:* At the test site, provide the Soldier with all the equipment given in the task conditions statement.

*Brief Soldier:* Tell the Soldier to remove the AN/PAS-13 TWS from the caliber .50 M2 machine gun.

Performance Measures	GO	NO GO
1. Checked to ensure that the weapon was clear.	___	___
2. Removed the TWS from the weapon.	___	___
3. Stowed the TWS and component parts.	___	___

**Evaluation Guidance:** Refer to chapter 1, paragraph 1-9e, (1) and (2).

### References

#### Required:

**Related:** TM 11-5855-302-12&P and TM 11-5855-309-12&P

## 071-022-0020

### Engage Targets with a Caliber .50 M2 Machine Gun Using an AN/PAS-13 Thermal Weapon Sight

**Conditions:** Given a tripod-mounted caliber .50 M2 machine gun, a mounted and zeroed AN/PAS-13 thermal weapon sight (TWS), linked .50-caliber ammunition, threat targets, and a requirement to engage such targets.

**Standards:** Detect and determine the range to the targets; fire the caliber .50 M2 machine gun to engage targets in the assigned sector of fire; and apply marksmanship fundamentals and target engagement techniques so each target is hit or suppressed.

### Performance Steps

1. Place the TWS into operation.
2. Assume an appropriate firing position based on the situation. This firing position should protect you from enemy fire and observation, yet allow you to place effective fire on targets in your sector of fire.
  - a. Tripod-supported prone position. Advantages: steady, easy to assume, low silhouette, and easily adapted to use of cover and support. Disadvantages: effectiveness can be limited by terrain and vegetation irregularities.
  - b. Tripod-supported fighting position. Advantages: best when available.
3. Identify targets in your designated sector of fire.
4. Load the weapon.
5. Acquire targets using the TWS reticle.

## Performance Steps

- a. Personnel: Place the target on the horizontal line and match its height with one of the vertical lines. Measurement is made from the horizontal line to the top (or bottom) of each vertical line for the range indicated. The vertical line reflects the height of a 5-foot man at the specified range.
  - b. Tank: When viewed from the side, place the left edge of a tank at the left side of the horizontal line. Read the range to the tank from the scale at the right edge of the tank. When viewed from the front or rear, use one-half of the indicated range value (since width of the tank is approximately one-half of the length of the tank). The horizontal line of a crosshair reflects the width of a 10-foot tank at the specified range.
  - c. The firing aiming point of each crosshair is the point of intersection of the vertical and horizontal lines.
6. Fire on target(s) until destroyed or until you receive an order to cease fire.

**Evaluation Preparation:** *Setup:* Evaluate this task on a live-fire range. Evaluate the Soldier's ability to use the correct engagement techniques for specific types of targets. Provide the Soldier with the equipment and materials in the task conditions statement.

*Brief Soldier:* Brief the Soldier on range safety according to the installation standing operating procedure (SOP), and tell the Soldier to engage each target.

Performance Measures	GO	NO GO
1. Placed the TWS into operation.	___	___
2. Assumed a suitable firing position.	___	___
3. Acquired targets.	___	___
4. Engaged the targets using the correct caliber .50 M2 machine gun firing techniques.	___	___

**Evaluation Guidance:** Refer to chapter 1, paragraph 1-9e, (1) and (2).

### References

#### Required:

**Related:** TM 11-5855-302-12&P and TM 11-5855-309-12&P

## 071-025-0027

### Mount an AN/PEQ-2A-Series Aiming Light on an M240B Machine Gun

**Conditions:** Given an M240B machine gun, AN/PEQ-2A-series aiming light, a preassembled AN/PEQ-2A insight rail grabber bracket, and the requirement to mount the aiming light to the M240B.

**Standards:** Mount the AN/PEQ-2A securely to the M240B machine gun without damage to the equipment.

## Performance Steps

### WARNING

Make sure the weapon is CLEAR and on SAFE before proceeding.

1. Mount the AN/PEQ-2A on the top cover rail using the preassembled AN/PEQ-2A insight rail grabber bracket.
2. Mount the bracket to the AN/PEQ-2A using the thumbscrew on the AN/PEQ-2A.
3. Loosen the clamping knob until the rail grabber has sufficient space to fit over the top cover rail. Tighten the clamping knob until you hear two clicks.
4. Place the AN/PEQ-2A at a position on the rail that is most convenient for the operator.
5. Install the remote switch in a convenient location using the provided cable hangers. Use the retainer straps to secure the remote switch cable to the weapon.

**Evaluation Preparation:** *Setup:* At the test site, provide the Soldier with all the equipment given in the task conditions statement.

*Brief Soldier:* Tell the Soldier to mount the AN/PEQ-2 on the M240B machine gun.

Performance Measures	GO	NO GO
1. Installed the aiming light on the weapon.	___	___

**Evaluation Guidance:** Refer to chapter 1, paragraph 1-9e, (1) and (2).

### References

#### Required:

**Related:** TM 11-5855-301-12&P

## 071-025-0028

### Dismount an AN/PEQ-2A-Series Aiming Light from an M240B Machine Gun

**Conditions:** Given an M240B machine gun with a mounted AN/PEQ-2A-series aiming light and carrying bag. The AN/PEQ-2A is in the OFF position, with batteries installed.

**Standards:** Remove the AN/PEQ-2A from the machine gun without damage to the equipment. Stow the AN/PEQ-2A, battery or batteries, and mounting knob assembly in the correct place in the carrying case.

## Performance Steps

1. Check to ensure that the machine gun is clear and on "S" (SAFE).
2. Remove the AN/PEQ-2A.
  - a. Secure the AN/PEQ-2A with one hand to prevent it from falling when the mounting knob assembly is removed.

### Performance Steps

- b. Rotate the mounting knob assembly counterclockwise until the assembly is free.
  - c. Remove the mounting knob assembly and AN/PEQ-2A from the machine gun.
3. Stow the AN/PEQ-2A and components.
  - a. Ensure that the mode selector is in the OFF position.
  - b. Ensure that the lens caps are over the respective output ports.
  - c. Remove the batteries.
  - d. Stow the AN/PEQ-2A and battery or batteries in the carrying case.

**Evaluation Preparation:** *Setup:* At the test site, provide the Soldier with all the materials given in the task conditions statement.

*Brief Soldier:* Tell the Soldier that he/she must remove and stow the AN/PEQ-2A without damage to the equipment.

Performance Measures	GO	NO GO
1. Removed the aiming light from the weapon.	___	___
2. Stowed the aiming light and components.	___	___

**Evaluation Guidance:** Refer to chapter 1, paragraph 1-9e, 1 and 2.

### References

#### Required:

**Related:** FM 3-22.68 and TM 11-5855-308-12&P

## 071-025-0030

### Engage Targets with an M240B Machine Gun Using an AN/PEQ-2A-Series Aiming Light

**Conditions:** Given an M240B with a mounted AN/PEQ-2A that has been zeroed. You have an assigned sector of fire, 7.62-mm ammunition, and a requirement to engage threat targets in your sector.

**Standards:** Fire the M240B to effectively engage targets in the assigned sector of fire and apply the correct M240B target-engagement techniques using the AN/PEQ-2A so that you hit each target.

### Performance Steps

1. Place the AN/PEQ-2A into operation.
2. Assume a suitable firing position. Based on the situation, assume the position that allows you to observe and engage targets, yet minimize your exposure to enemy fire.

## Performance Steps

- a. Tripod firing. A number of firing positions can be used based on the situation (prone, sitting, or kneeling, or standing if firing from a prepared position).
  - b. Bipod firing. Prone-supported position and bipod-supported fighting position are the best positions for delivering effective fire on targets when using the AN/PEQ-2A. Assume these positions when possible.
3. Acquire targets.
- a. Detect and estimate the range to the target.
  - b. Acquire a good sight picture on the target and adjust the weapon to place the correct aiming point (based on range to target) on the center base of the target.
4. Engage targets using the correct M240B firing techniques.

**Evaluation Preparation:** *Setup:* Evaluate this task on a live-fire range. Evaluate the Soldier's ability to use correct engagement techniques to engage specific types of targets. Provide the Soldier with the equipment in the task conditions statement.

*Brief Soldier:* Brief the Soldier on range safety according to the installation standing operating procedure (SOP). Tell the Soldier to assume a bipod-supported prone position or the bipod-supported fighting position. Tell him/her that you are evaluating his/her ability to place effective fire on targets using the AN/PEQ-2A-equipped M240B machine gun.

Performance Measures	GO	NO GO
1. Placed the AN/PEQ-2A into operation.	_____	_____
2. Assumed a suitable firing position.	_____	_____
3. Acquired targets.	_____	_____
4. Engaged the targets using the correct firing techniques.	_____	_____

**Evaluation Guidance:** Refer to chapter 1, paragraph 1-9e, (1) and (2).

### References

#### Required:

**Related:** FM 3-22.68 and TM 11-5855-308-12&P

## 071-030-0016

### Mount a Night Vision Sight, AN/TVS-5, on an MK19 Machine Gun

**Conditions:** Given an MK19 machine gun, MK 64 gun cradle, traverse and elevating (T&E) mechanism mounted on a vehicle or the M3 tripod; M2 mounting bracket; and night vision sight, AN/TVS-5.

**Standards:** Mount the night vision sight, AN/TVS-5, securely on the MK19 without damage to the equipment.

## Performance Steps

1. Mount the M2 mounting bracket on the MK19.
  - a. Slide the M2 mounting bracket over the rear sight housing from the muzzle end of the gun.

*Note:* You must lock the locking cams in sequence.
  - b. Lock the M2 mounting bracket locking cams by swinging them to the rear.
    - (1) Lock the side cam.
    - (2) Lock the left top cam.
    - (3) Lock the right top cam.
2. Mount the AN/TVS-5 on the M2 mounting bracket.
  - a. Position the AN/TVS-5 on the mounting bracket in the groove at the top rear of the mounting bracket so that the scribe line on the bracket is aligned with the scribe line on the sight mounting adapter.
  - b. Insert the lever screw from the bottom of the bracket into the sight mounting bracket.
  - c. Tighten the lever screw.

**Evaluation Preparation:** *Setup:* A mounted MK19, an AN/TVS-5, and an M2 mounting bracket is required at each test site.

*Brief Soldier:* Tell the Soldier to mount the AN/TVS-5 on the MK19.

Performance Measures	GO	NO GO
1. Mounted the M2 mounting bracket on the MK 19.	___	___
2. Mounted the AN/TVS-5 on the M2 mounting bracket.	___	___

**Evaluation Guidance:** Refer to chapter 1, paragraph 1-9e, (1) and (2).

### References

#### Required:

**Related:** FM 3-22.27 and TM 11-5855-214-10

## 071-030-0017

### Dismount a Night Vision Sight, AN/TVS-5, from an MK19 Machine Gun

**Conditions:** Given an MK19 machine gun with a mounted night vision sight, AN/TVS-5.

**Standards:** Remove the night vision sight, AN/TVS-5, and mounting bracket from the MK19 without damage to the equipment.

## Performance Steps

1. Remove the lever screw.
2. Remove the AN/TVS-5 from the mounting bracket.

### Performance Steps

3. Unlock the mounting bracket locking cams in sequence.
  - a. Unlock the right top cam.
  - b. Unlock the left top cam.
  - c. Unlock the side cam.
4. Remove the mounting bracket from the MK 19.

**Evaluation Preparation:** *Setup:* An MK19 with a mounted night vision sight, AN/TVS-5, is required at each test site.

*Brief Soldier:* Tell the Soldier to dismount the AN/TVS-5 from the MK19.

Performance Measures	GO	NO GO
1. Removed the lever screw.	___	___
2. Removed the AN/TVS-5 from the mounting bracket.	___	___
3. Unlocked the mounting bracket locking cams in sequence. <ol style="list-style-type: none"><li>a. Unlocked the right top cam.</li><li>b. Unlocked the left top cam.</li><li>c. Unlocked the side cam.</li></ol>	___	___
4. Removed the mounting bracket from the MK 19.	___	___

**Evaluation Guidance:** Refer to chapter 1, paragraph 1-9e, (1) and (2).

### References

### Required:

**Related:** FM 3-22.27 and TM 11-5855-214-10

## 071-030-0019

### Engage Targets with an MK19 Machine Gun Using a Night Vision Sight, AN/TVS-5

**Conditions:** During darkness, given an MK19 machine gun equipped with night vision sight, AN/TVS-5, and mounted on an M3 tripod or vehicle carrier; linked 40-mm grenade ammunition; targets at engageable ranges; targets that could be likely enemy locations (woodlines, hedgerows, buildings); and a requirement to engage such targets.

**Standards:** Destroy, disable, or neutralize targets.

### Performance Steps

1. Assume a firing position.
2. Sight through the night vision sight, AN/TVS-5, and determine range to the target.

### Performance Steps

3. Based on range to the target, place the correct aiming point on the target.
4. Lay the weapon on the target using the correct sight alignment, correct sight picture, and the following engagement techniques:
  - a. Linear targets. Lay the gun on center of mass of the target and use traversing fire to cover the target area.
  - b. Linear targets with depth. Lay the gun on the center of mass of the target. Use traversing and searching fire to cover the target area, covering the side closest to the gun position first.
  - c. Deep targets. Lay the gun on the center of mass of the target area. Search down to the near end and then up to the far end.
5. Adjust fire by observing the strike of the projectiles into the target area.

**Evaluation Preparation:** *Setup:* An MK19 with traversing and elevation (T&E) mechanism and feed throat assembly, tripod-mounted with the M36A2 ring mount and M66 ring is required at each test station.

*Brief Soldier:* Tell the Soldier to place the night vision sight, AN/TVS-5, into operation and engage targets with the MK19.

Performance Measures	GO	NO GO
1. Placed the AN/TVS-5 into operation.	___	___
2. Assumed a suitable firing position.	___	___
3. Acquired targets.	___	___
4. Engaged the targets using the correct MK19 firing techniques.	___	___

**Evaluation Guidance:** Refer to chapter 1, paragraph 1-9e, (1) and (2).

### References

#### Required:

**Related:** FM 3-22.27 and TM 9-1010-230-10

## 071-100-0017

### Mount an AN/PAQ-4-Series Aiming Light on an M4 or M4A1 Carbine

**Conditions:** Given a cleared M4 or M4A1 carbine and an AN/PAQ-4-series aiming light.

**Standards:** Attach and secure the AN/PAQ-4 to the M4 or M4A1 carbine without damage to equipment.

### Performance Steps

1. Clamp the M4 mounting bracket to the barrel of the M4 or M4A1 with the knob on the right, positioning the aiming light vertically on the side of the weapon.



## Performance Steps

### WARNING

Make sure the weapon is clear and on SAFE before proceeding.

- a. Fully loosen the bracket knob and place the bracket on the M4 carbine so that the jaws surround the barrel, and so the notch at the rear of the bracket engages the front sight post.
  - b. Hand tighten the knob. Fold down the metal ring.
  - c. Turn the ON/OFF switch counterclockwise (CCW) to the #1 OFF/STORAGE position.
  - d. Position the aiming light on the bracket mounting rail.
2. Hand tighten the thumbscrew to secure the aiming light.

**Evaluation Preparation:** *Setup:* At the test site, provide all equipment and materials given in the task conditions and statement.

*Brief Soldier:* Tell the Soldier to mount the AN/PAQ-4-series aiming light on an M4 or M4A1 carbine.

Performance Measures	GO	NO GO
1. Mounted the AN/PAQ-4 to an M4 or M4A1.	___	___
a. Fully loosened the bracket knob and placed the bracket on the M4 carbine so that the jaws surrounded the barrel, and so that the notch at the rear of the bracket engaged the front sight post.		
b. Hand tightened the knob. Folded down the metal ring.		
c. Turned the ON/OFF switch counterclockwise to the #1 OFF/STORAGE position.		
d. Positioned the aiming light on the bracket mounting rail.		
2. Hand tightened the thumbscrew to secure the aiming light.	___	___

**Evaluation Guidance:** Refer to chapter 1, paragraph 1-9e, (1) and (2).

### References

### Required:

**Related:** TM 11-5855-301-12&P

---

## 071-100-0020

### Zero an AN/PAQ-4-Series Aiming Light to an M4 or M4A1 Carbine

**Conditions:** Given an AN/PAQ-4-series aiming light mounted on an M4 or M4A1 carbine and an M16A2 25-meter zeroing target.

**Standards:** Zero the AN/PAQ-4 to the M4 or M4A1 carbine it is mounted on. Fire the weapon and hit the designated strike zone with two out of three rounds.

#### Performance Steps

1. Boresight the AN/PAQ-4 to the M4.

a. Check the alignment of the borelight.

(1) Place the appropriate mandrel with the borelight attached in the muzzle of the weapon.

(2) Turn on the borelight so that the laser dot strikes the target (offset) 10 meters away.

(3) Slowly rotate the borelight one-half of a turn (180 degrees) while watching the dot made by the laser on the target area. If the dot remains stationary, the laser is boresighted. If the dot rotates in a circle adjust the windage or elevation or both until the dot remains stationary or rotates on itself no more than 1 centimeter.

b. Adjust the borelight (if necessary).

(1) Move the target to a distance of 2 meters.

(2) Mark the location of the laser dot.

(3) Slowly rotate the borelight one-half of a turn.

(4) Note the new location of the laser dot.

(5) Adjust the windage and elevation until the laser dot moves halfway back to its original location.

(6) Continue the procedure until the laser dot remains stationary (or spins upon itself within 1 centimeter) when the borelight is rotated.

(7) Move the target to a distance of 10 meters, and recheck the boresight.

c. Boresight the AN/PAQ-4 to the M4.

(1) Position the weapon so the borelight strikes the small dot on the boresight target.

(2) Zero the aiming light by turning both windage and elevation knobs (for the pointer and illuminator) fully clockwise until they stop. Rotate counterclockwise five and one-half turns. Align the white dot on the adjuster with the center of the front adjuster flange.

(3) Adjust the aiming light until the emitted laser is on the appropriate dot on the boresight target. The weapon is boresighted when the laser borelight is on the small dot and the emitted laser is on the cross.

**Note:** You must use a night vision goggle in order to see the dot from the laser. Boresight zeroing must be conducted at 10 meters.

2. Zeroing.

---

### Performance Steps

- a. When the weapon is sighted precisely center of mass of the 25-meter target, the beam looks dimmer. Fire a round.
- b. Choose the appropriate 25-meter strike zone for the weapon you are using and draw the strike zone on the 25-meter zero target.
- c. Staple the 25-meter zero target on an E-type silhouette and cut a 4-centimeter square out of the center through both the target paper and the E-type silhouette. Then place the target on the 25-meter range.
- d. Fire a three-round shot group. Remember to fire when the infrared aiming light beam goes through the 4-centimeter cutout in the target (the beam will appear dimmer).
- e. Triangulate the three-round shot group. Adjust the windage and elevation knobs on the aiming light to move the impact of the rounds to the designated strike zone.
- f. Repeat steps d and e until five out of six rounds from two consecutive shot groups hit within the designated strike zone.

**Evaluation Preparation:** *Setup:* At the test site, provide the Soldier with all the equipment given in the task conditions statement.

*Brief Soldier:* Tell the Soldier that he/she must zero the AN/PAQ-4 to an M4 or M4A1 carbine.

Performance Measures	GO	NO GO
1. Placed the AN/PAQ-4-series aiming light into operation.	___	___
2. Zeroed the aiming light to the M4 or M4A1 rifle.	___	___

**Evaluation Guidance:** Refer to chapter 1, paragraph 1-9e, (1) and (2).

#### References

#### Required:

**Related:** FM 21-75, FM 3-22.9, and TM 11-5855-301-12&P

## 071-705-0001

### Maintain an M68 Sight

**Conditions:** Given an M68 sight with components, battery (OE890) DL1/3N, clean water, cleaning tissues, and a requirement to perform required unit maintenance on the sight.

**Standards:** Clean and inspect the sight, components, and accessories for serviceability; report unserviceable items to the supervisor. Comply with all warnings and cautions.

### Performance Steps

1. Clean the M68 sight.

## Performance Steps

- a. Remove large particles from the exposed lens surfaces by first blowing on the surfaces. Blow as much dust and dirt as possible from the exposed lens surfaces.
  - b. When all visible particles of dust and dirt have been removed, moisten a piece of lens paper, then gently wipe over the lens surface. Dry with clean lens paper.
2. Inspect the M68 sight, quick release, and mount for conditions indicated.
- a. Look through the sight. Inspect for visual obstruction of the target image, dust, dirt, pits or moisture on the optical surfaces, and loose or broken optical elements.
  - b. Ensure that the battery cap is present and that the battery cap's threads are clean and undamaged. Inspect the O-ring and the spring in the battery cap.
  - c. Ensure that the red dot is visible when the rotary switch is set to one of the operating positions.
  - d. Check the mounting bracket for damage that will prevent the sight from being installed.
  - e. Ensure that both the adjustment caps are present and that the threads are clean and undamaged.
  - f. Ensure that both the lens covers are present and can be snapped in place.
  - g. Check the mount for damage that will prevent it from being installed on the M16A2.
  - h. Check the mount for damage that would prevent installation of the sight.

**Evaluation Preparation:** *Setup:* Provide the Soldier with the equipment and materials listed in the task condition statement.

*Brief Soldier:* Tell the Soldier to inspect the sight and components for completeness and serviceability and to clean them as required.

Performance Measures	GO	NO GO
1. Cleaned the M68 and components; used the correct cleaning techniques.	___	___
2. Inspected the sight and components for serviceability.	___	___

**Evaluation Guidance:** Refer to chapter 1, paragraph 1-9e, (1) and (2).

### References

#### Required:

**Related:** TM 9-1240-413-12&P

---

## 071-705-0002

### Operate an M68 Sight

**Conditions:** Given an M68 sight with components and battery (3 volt, DL1/3N) mounted on an M16A2 rifle or an M4/M4A1 carbine.

**Standards:** Prepare and correctly place the M68 sight into operation.

#### Performance Steps

1. Install the battery.
  - a. Remove the battery cap by turning it counterclockwise.
  - b. Insert the battery with the positive end (+) toward the cap.

#### CAUTION

Before installing the battery cap, inspect the threads on the battery housing and battery cap to ensure that they are free of moisture and dirt and that the O-ring in the battery cap is present. Failure to do so could result in the loss of power and shorten battery life.

- c. Install the battery cap by turning clockwise until snug. Hand tighten only.
    - d. Open the rear lens cover. Turn the rotary switch clockwise and look through the rear lens. Verify that the red dot is present. If red dot is not present, replace the battery. When finished, turn the rotary switch counterclockwise to the OFF position, and then close the rear lens cover.
2. Light adjustment:

#### WARNING

At higher intensity settings, the red dot is visible through the front of the sight. For night vision operations, close the front lens cover before turning the rotary switch clockwise to positions 1 or 2. Check the light for the proper intensity before opening the front lens cover. Close the front lens cover before turning the rotary switch counterclockwise to the OFF position. Failure to follow this warning could reveal your position to the enemy.

**Note:** The sight is equipped with 10 positions: one OFF position and 9 positions for different dot intensity settings.

- a. Turn the rotary switch clockwise to make light adjustments. The first two positions are low intensity for night vision operations. The third position is the lowest daytime setting. The last position is the extra high-intensity (EHI) setting.
    - b. Close the lens cover and turn the rotary switch counterclockwise to the OFF position when the sight is not being used.
3. Sighting:
  - a. Two-eyes-open method (preferred). Position the head so that you can focus one eye on the red dot and can scan downrange with the other eye. Place the red dot on the center of mass of the target and engage.

## Performance Steps

b. One-eye-open method. With the nonfiring eye closed, look through the sight to ensure that the red dot can be seen clearly. Place the red dot on the center of mass of the target and engage.

**Note:** The aiming method used to zero must also be used to engage targets. The weapon must not be canted during aiming or firing.

**Evaluation Preparation:** *Setup:* At the test site, provide the Soldier with all the equipment given in the task conditions statement.

*Brief Soldier:* Tell the Soldier to place the M68 sight into operation.

Performance Measures	GO	NO GO
1. Installed the battery.	___	___
2. Set the light adjustment to the proper setting.	___	___
3. Used the proper sighting method.	___	___

**Evaluation Guidance:** Refer to chapter 1, paragraph 1-9e, (1) and (2).

## References

### Required:

**Related:** TM 9-1240-413-12&P

## 071-705-0003

### Zero an M68 Sight

**Conditions:** Given an M68 sight, a zeroed M16-series rifle, a zeroed M4 carbine, a zeroed M4 modular weapon system, components, battery (0E890) DL1/3N, 25-meter range, and the appropriate ammunition.

**Standards:** Zero an M68 sight by firing accurately at a zeroed target, and impact the of center mass with a three-round shot group upon zero confirmation.

## Performance Steps

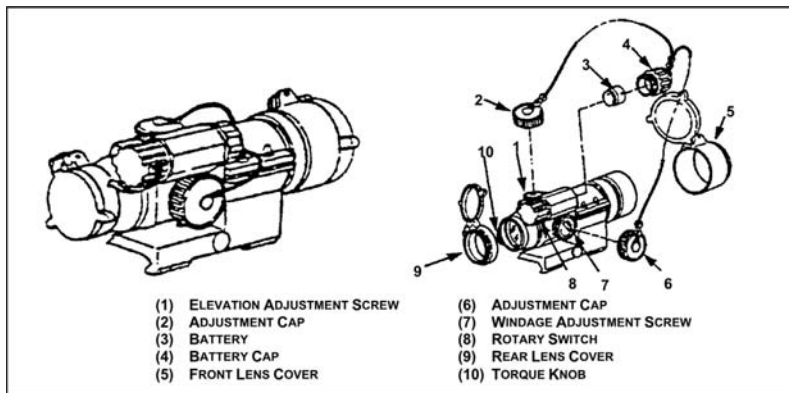

Figure 071-705-0003-1. M68, close combat optic

1. Place an M68 sight into operation.

## Performance Steps

### 2. Zero the M68 sight:

- a. Open the front and rear lens covers (figure 071-705-0003-1).
- b. Turn the rotary switch clockwise until the red dot intensity contrasts suitably with the target background.
- c. Look through the sight to get a rough estimate of the zeroing adjustment required. When looking through the iron sights, the red dot should appear on top of the front sight post.
- d. If adjustment is required, remove adjustment screw caps from adjustment screws by turning them counterclockwise (Figure 071-705-0003-1).  
*Note:* Each click of the adjustment screw makes a 4-millimeter movement of the point of impact at 25 meters ( $\frac{1}{2}$  minute of adjustment [MOA]).
- e. Insert an adjustment tool (coin, screwdriver, or knife) into the adjustment screw slot. Turn the adjustment screw as follows:
  - (1) To move the point of impact to the right, turn the windage adjustment screw counterclockwise.
  - (2) To move the point of impact to the left, turn the windage adjustment screw clockwise.
  - (3) To move the point of impact up, turn the elevation adjustment screw counterclockwise.
  - (4) To move the point of impact down, turn the elevation adjustment screw clockwise.
- f. Repeat step (c) through step (e) until the sight is roughly zeroed.
- g. Confirm zeroing by firing at least three shots at a zeroing target. Check the impact points on the zeroing target to confirm accuracy.  
*Note:* After initial firing, check to ensure that the mount and sight (M16-series or M4-series) are secure. On the M16-series, hand tighten the mounting bolt on the mount, then hand tighten the torque knob on the sight until it snaps twice. On the M4-series, hand tighten the torque knob on the sight until it snaps twice.
- h. If zeroing is accurate, fire three more shots to confirm. If zero is not accurate, repeat step (e) through step (g) until zeroing is complete.
- i. Install the adjustment cap by rotating clockwise, and then hand tighten the cap.

***Note:*** Sight picture—place the red dot on center of mass of the target and engage.

**Evaluation Preparation:** *Setup:* When the borelight is unavailable, use the iron sights on a zeroed weapon to zero the M68 sight. On an M4-series carbine, reconfirm zero if the M68 sight is moved to a different slot on the rail.

*Brief Soldier:* Tell the Soldier that each click of the adjustment screw moves the point of impact  $\frac{1}{2}$  MOA at 25 meters, and that he/she must use the same aiming method (one or both eyes open) to zero that he/she uses to engage targets.

Performance Measures	GO	NO GO
1. Opened the lens covers and turned the rotary switch clockwise until the red dot intensity contrasted suitably with the target background on the M68 sight.	___	___
2. Looked through the sight to get a rough estimate of the zeroing adjustment required.	___	___
3. Removed (if required) the adjustment screw caps from the adjustment screws by turning them counterclockwise.	___	___
4. Inserted (if required) an adjustment tool (coin, screwdriver, knife) into the adjustment screw slot and made the appropriate adjustments.	___	___
5. Zeroed the M68 sight by firing and striking the zero target center of mass with a three-round shot group.	___	___
6. Confirmed zero by firing another three-round shot group at a zero target, checked the impact points on the target, confirmed accuracy.	___	___
7. Installed the adjustment (did not use tools) caps by rotating clockwise and hand tightened.	___	___

**Evaluation Guidance:** Refer to chapter 1, paragraph 1-9e, (1) and (2).

#### References

#### Required:

**Related:** FM 3-22.9, TM 9-1005-319-10, and TM 9-1240-413-12&P

## 071-705-0004

### Boresight an M68 Sight

**Conditions:** Given an M68 sight with components, boresight target, and battery (0E890) DL1/3N.

**Standards:** Center the red dot of an M68 sight on the black dot of the boresight target, center of mass.

#### Performance Steps

1. Check the alignment of the borelight.
  - a. Place the appropriate mandrel (with borelight attached) into the muzzle of the weapon.
  - b. Turn on the borelight so the laser beam strikes the boresight target offset 10 meters away.
  - c. Slowly rotate the borelight one-half of a turn (180 degrees), while watching the beam on the target area (note any circular pattern made).
  - d. If the beam remains stationary, the laser is boresighted; go to step 3.





**10-METER BORESIGHT TARGET**

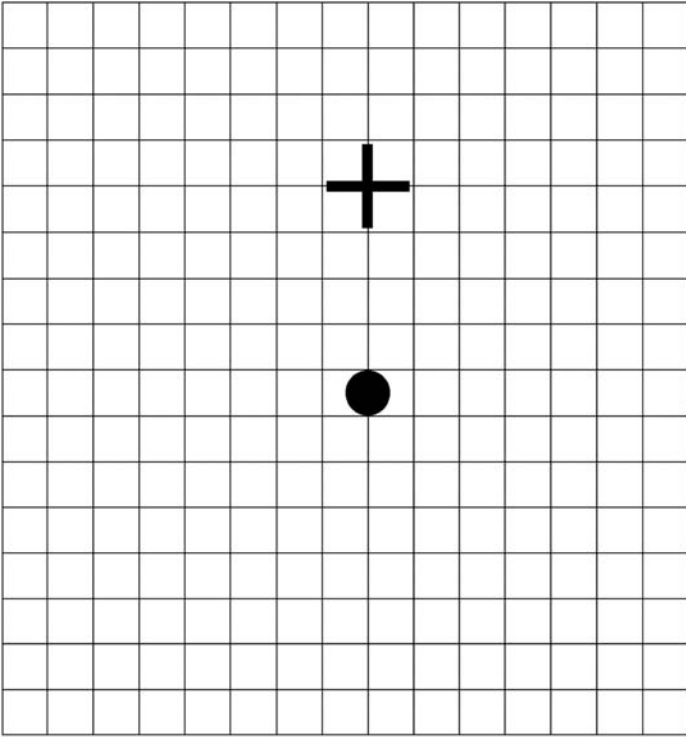

At a range of 10 meters aim at the cross and adjust the CCO so that the bore light strikes the dot.

**Figure 071-705-0004-1. 10-meter boresight target for M16-series rifle**

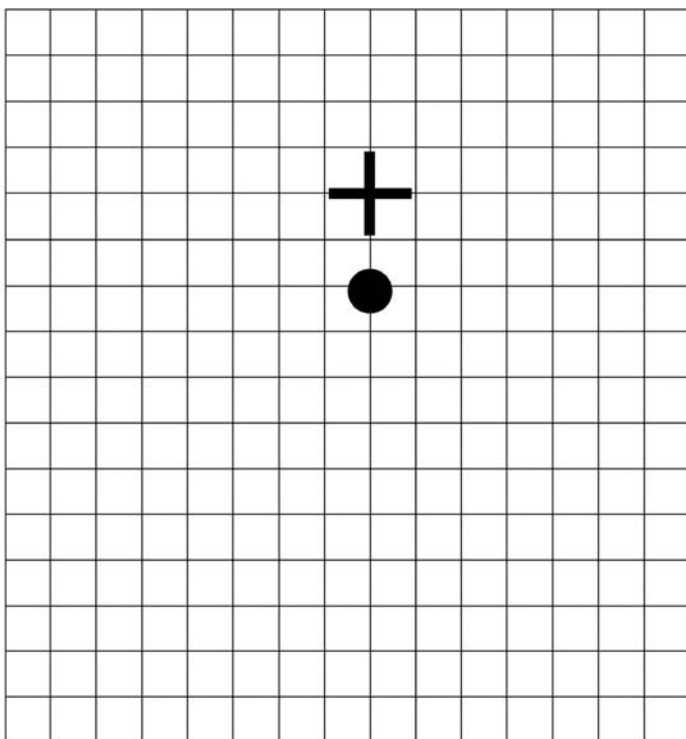
**10-METER BORESIGHT TARGET**

At a range of 10 meters aim at the cross and adjust the CCO so that the bore light strikes the dot.

**Figure 071-705-0004-2. 10-meter boresight target for M4-series carbine**

- b.** Position the weapon so the borelight strikes the black dot on the boresight target.
  - c.** Adjust the M68 sight until the red dot centers on the cross on the boresight target offset.
  - d.** The weapon is boresighted when the laser borelight is on the black dot, and the red dot (from the M68 sight) centers on the cross.
- 4.** Adjust the M68 sight as follows:
-

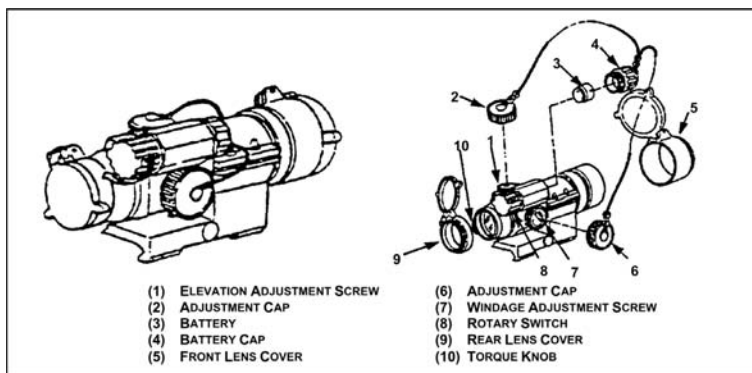

Figure 071-705-0004-3. M68, close combat optic

- a. Elevation adjustment screw (figure 071-705-0003-1): One click at 25 meters equals 4 millimeters; clockwise equals down.
- b. Windage adjustment screw (figure 071-705-0003-1): One click at 25 meters equals 4 millimeters; clockwise equals left.
- c. Rotary switch—10 positions (figure 071-705-0003-1):
  - (1) Position 1 equals OFF.
  - (2) Position 2 equals NIGHT.
  - (3) Positions 3 through 10 equal daytime intensity.

**Evaluation Preparation:** *Setup:* Before boresighting the weapon and M68 sight, zero the iron sights as outlined in FM 3-22.9.

*Brief Soldier:* Tell the Soldier to boresight the weapon without damaging equipment or injuring personnel.

*Note:* At ranges of 150 meters and beyond, the effects of parallax are minimal. However, at ranges within 25 meters, parallax exists and the firer must keep the red dot centered while boresighting or zeroing.

Performance Measures	GO	NO GO
1. Checked the alignment of the borelight.	_____	_____
2. Adjusted the borelight (if necessary).	_____	_____
3. Boresighted the M68 sight to the weapon.	_____	_____
4. Made appropriate sight adjustments.	_____	_____

**Evaluation Guidance:** Refer to chapter 1, paragraph 1-9e, (1) and (2).

**References**

**Required:**

**Related:** FM 3-22.9 and TM 9-1240-413-12&P

## 071-004-0001

### Maintain an M9 Pistol

**Conditions:** Given an M9 pistol with components (M12 or M7 holster, magazine, and ammunition pocket); 9-mm ammunition; cleaner lubricant, and preservative (CLP); lubricating oil arctic weather (LAW); lubricating oil semifluid (LSA); bore brush; wiping rags; M4 cleaning rod (a one-section handle and a swab holder); and small arms cleaning swabs.

**Standards:** Clean and lubricate an M9 pistol and magazine; inspect parts; turn in unserviceable parts for maintenance; assemble the pistol; ensure that the pistol is operational; clean and inspect ammunition for serviceability; and turn in unserviceable ammunition.

#### Performance Steps

1. Clear the pistol.
  - a. Place the safety lever in the SAFE position.
  - b. Hold the pistol in the raised pistol position.
  - c. Depress the magazine release button; remove the magazine from the pistol.
  - d. Pull the slide to the rear; remove any chambered round.
  - e. Push the slide stop up, locking the slide to the rear.
  - f. Look into the chamber to ensure that it is empty.
2. Disassemble the pistol and magazine.
  - a. Depress the slide stop and let the slide go forward.
  - b. With your right hand, hold the pistol with the muzzle slightly raised.
  - c. With your forefinger, press the disassembly lever button (figure 071-004-0001-1).

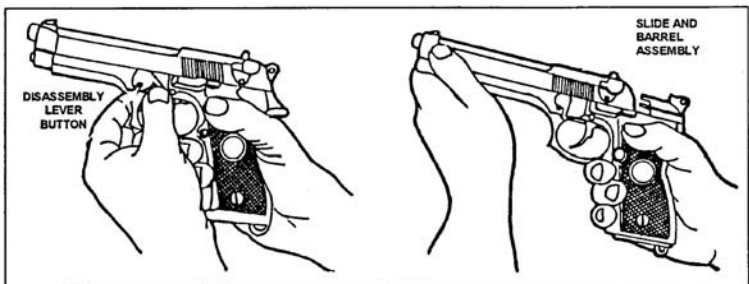
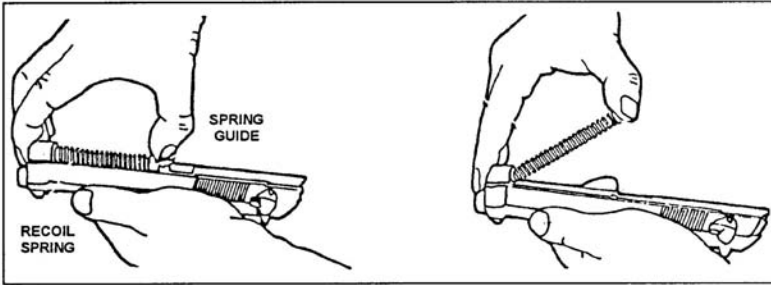

Figure 071-004-0001-1. Disassembly lever button

## Performance Steps

- d. Rotate the disassembly lever downward until it stops.
- e. Pull the slide and barrel assembly forward (figure 071-004-0001-1), and remove it from the receiver.
- f. Slightly compress the recoil spring and spring guide. At the same time, lift them up and remove them, allowing the recoil spring to stretch slowly (figure 071-004-0001-2).



**Figure 071-004-0001-2. Removal of the recoil spring and spring guide**

- g. Separate the recoil spring from the spring guide.
- h. Push in on the locking block plunger while pushing the barrel forward slightly. Lift and remove the locking block and barrel assembly from the slide (figure 071-004-0001-3).

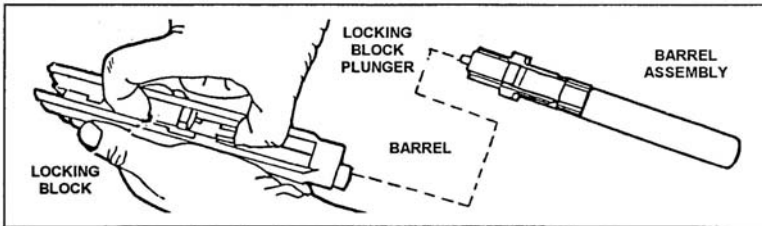

**Figure 071-004-0001-3. Removal of the locking block and barrel assembly**

- i. Disassemble the magazine (figure 071-004-0001-4).

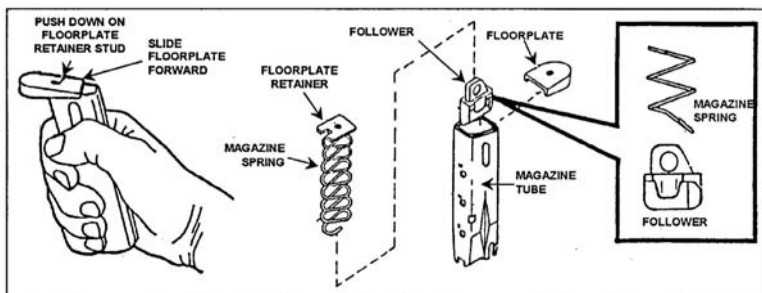

Figure 071-004-0001-4. Disassembly of the magazine

- (1) Grasp the magazine firmly, with the floor plate up and the back of the magazine tube against the palm of your hand.
  - (2) Depress the locking block to make the locking block plunger protrude.
  - (3) Using the locking block plunger, push down on the floor plate retainer stud.
  - (4) Slide the floor plate slightly forward with your thumb.
  - (5) While removing the floor plate, use your thumb to keep pressure on the magazine spring.
  - (6) Remove the floor plate retainer, the magazine spring, and the follower from the magazine tube.
  - (7) Remove the magazine spring from the follower.
  - (8) Remove the floor plate retainer from the magazine spring.
3. Clean the pistol and magazine.

**CAUTION**

Use the bore brush to clean only the bore. Using it on any other part of the pistol will cause damage.

- a. Slide assembly.
  - (1) Clean the slide assembly with a cloth. Use CLP on a soft brush to remove excess dirt and carbon.
  - (2) Wipe the slide assembly dry with a clean cloth.
- b. Barrel assembly.
  - (1) Attach a bore brush to a cleaning rod. Moisten the bore brush with CLP and insert it into the chamber end of the barrel. Make sure the brush completely clears the muzzle before pulling it back through the bore. Repeat this procedure several times to loosen carbon deposits.
  - (2) To clean and dry the barrel, push a clean swab through the bore. Repeat as necessary with fresh swabs until a swab comes out clean.
  - (3) Clean the locking block with a soft brush.
  - (4) Clean the recoil spring and spring guide with CLP and a soft brush or cloth.

## Performance Steps

c. Receiver assembly. Wipe the receiver assembly clean with a cloth and, if needed, a soft brush.

d. Magazine (figure 071-004-0001-4).

(1) Wipe the magazine tube and the follower with CLP, a cloth, and a soft brush.

(2) Clean the magazine spring, floor plate retainer, and floor plate with a clean cloth.

e. Holster. Remove dirt from the exterior with a stiff brush. Wipe the interior with a clean cloth.

f. Ammunition. If ammunition gets wet or dirty, clean it and remove corrosion from it immediately using a dry cloth.

4. Inspect for serviceability.

a. Slide assembly.

(1) Check to ensure that the ambidextrous safety moves freely.

(2) Check the firing block for damage.

(3) Check the rear sight for looseness.

b. Barrel assembly.

(1) Inspect the bore and chamber for pitting or obstructions.

(2) Check the locking block plunger to ensure the locking block moves freely.

(3) Inspect the locking lugs for cracks and burrs.

c. Recoil spring and recoil spring guide.

(1) Check the recoil spring to ensure that it is not bent or damaged.

(2) Check the recoil spring to ensure that it is straight and free of cracks and burrs.

d. Receiver assembly.

(1) Check for bends, chips, and cracks.

(2) Check to ensure that the slide stop and magazine stop move freely.

(3) Check the guide rails for excessive wear, burr, cracks, or chips.

e. Magazine assembly (figure 071-004-0001-4).

(1) Check for damage to the spring and follower.

(2) Inspect the magazine lips to ensure they are not bent excessively and to ensure they have no cracks and burrs.

(3) Check to ensure that the magazine tube is not bent.

f. Ammunition.

(1) Check for damaged or corroded ammunition. Turn in heavily corroded or damaged ammunition.

(2) Check to ensure that the ammunition is free of oil and grease.

5. Lubricate the pistol and magazine.



## Performance Steps

**Note:** CLP, LSA, and LAW are the only lubricants authorized for this pistol.

**Note:** You can use CLP and LSA interchangeably.

**Note:** Before firing, remove excess lubricant from the bore.

- a. Lubricate all parts with a light coat of LSA or CLP at temperatures above -10 degrees Fahrenheit, or LAW at temperatures below +10 degrees Fahrenheit.
  - b. Do not mix LAW with other lubricants.
6. Assemble the pistol (figure 071-004-0001-5).

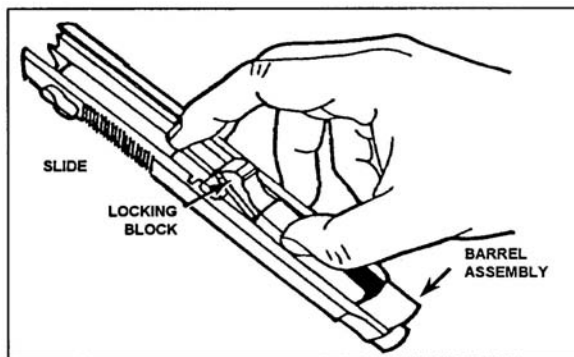

Figure 071-004-0001-5. Insertion of the barrel assembly

- a. Grasp the slide with the bottom facing up.
- b. With the other hand, grasp the barrel assembly with the locking block facing up.
- c. Insert the muzzle into the forward end of the slide. At the same time, lower the rear of the barrel assembly by moving the barrel slightly downward with light thumb pressure. The barrel will fall into place.
- d. Insert the recoil spring guide into the recoil spring (figure 071-004-0001-6).

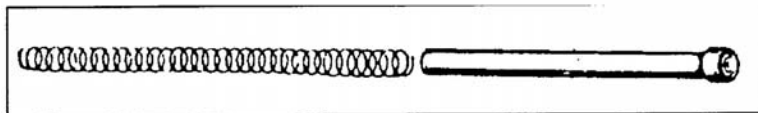

Figure 071-004-0001-6. Recoil spring and spring guide

- e. Insert the end of the recoil spring and the recoil spring guide into the recoil spring housing. At the same time, compress the recoil spring and lower the spring guide until it is fully seated on the locking block cutaway (figure 071-004-0001-7).

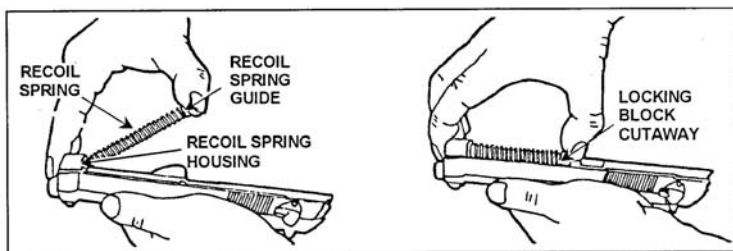

Figure 071-004-0001-7. Insertion of the recoil spring and guide

**CAUTION**

Be sure that the hammer is uncocked and firing pin block lever is in the down position. If the hammer is cocked, carefully and manually lower the hammer. Do not pull the trigger while placing the slide onto the receiver.

- f. Push the firing pin block lever down. Grasp the slide and barrel assembly with the sights up, and align the slide on the receiver assembly guide rails (figure 071-004-0001-8).

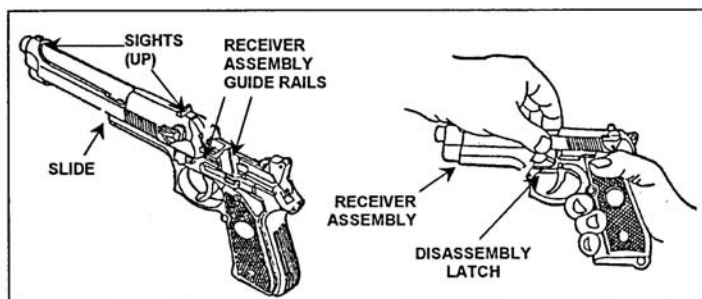

Figure 071-004-0001-8. Final assembly

- g. Push until the rear of the slide is a short distance beyond the rear of the receiver assembly and hold. At the same time, rotate the disassembly latch lever upward. A click indicates a positive lock (figure 071-004-0001-8).

- h. Assemble the magazine.

(1) Insert the follower into the top coil of the magazine spring. Make sure the notches on the follower and magazine tube are on the same side.

(2) Insert the magazine spring with the follower into the magazine tube.

(3) Turn the magazine bottom up, with its backside against the palm of the hand. Attach and center the floor plate retainer on the bottom spring coil.

**CAUTION**

After inserting the magazine spring, keep tension on it with your thumb. Be careful not to place the lips of the magazine tube on a hard surface while you reassemble the magazine.

### Performance Steps

- (4) Push and hold the magazine spring and floor plate retainer down. At the same time, slide the floor plate over the sidewalls until it seats fully.
- (5) Carefully insert the magazine into the pistol well. You will hear a click when it locks into position.

### WARNING

Make sure the pistol is clear and unloaded.

7. Perform a function check.

**Evaluation Preparation:** *Setup:* At the test site, provide a field table with all the equipment given in the task conditions statement.

*Brief Soldier:* Tell the Soldier to clear, disassemble, clean, inspect, lubricate, assemble, and perform a function check on the weapon.

Performance Measures	GO	NO GO
1. Cleared the pistol.	___	___
2. Disassembled the pistol and magazine without damaging any parts.	___	___
3. Cleaned the pistol, components, and ammunition.	___	___
4. Inspected the pistol, components, and ammunition for defects.	___	___
5. Correctly lubricated the pistol and magazine.	___	___
6. Assembled the pistol and magazine in the correct sequence.	___	___
7. Performed a function check.	___	___

**Evaluation Guidance:** Refer to chapter 1, paragraph 1-9e, (1) and (2).

### References

**Required:**

**Related:** TM 9-1005-317-10

## 071-004-0003

### Load an M9 Pistol

**Conditions:** Given an unloaded M9 pistol and a separate magazine loaded with M9 ammunition.

**Standards:** Correctly load the magazine and ammunition into the pistol; ensure that the safety lever is in the safe position.

## Performance Steps

### WARNING

The M9 pistol has single- and double-action firing modes. When the safety is set to FIRE, squeezing the trigger will automatically cock and fire the pistol (this is the double-action mode).

Keep your finger away from the trigger until you intend to fire.

1. Place the safety lever in the SAFE position.
2. Insert the loaded magazine into the pistol's magazine well until you hear a click when the magazine seats fully.
3. Point the pistol in a safe direction (usually at the target or skyward).
4. Retract the slide fully and release it. This strips a cartridge from the magazine and chambers it.

**Evaluation Preparation:** *Setup:* At the test site, provide the equipment listed in the task conditions statement. Use dummy rounds to evaluate this task.

*Brief Soldier:* Tell the Soldier to load the M9 pistol so it will fire a round when he/she squeezes the trigger.

Performance Measures	GO	NO GO
1. Placed the safety lever in the SAFE position.	___	___
2. Inserted the loaded magazine into the magazine well.	___	___
3. Pointed the pistol in a safe direction (usually at the target or skyward).	___	___
4. Retracted and released the slide to chamber a cartridge from the magazine.	___	___

**Evaluation Guidance:** Refer to chapter 1, paragraph 1-9e, (1) and (2).

### References

#### Required:

**Related:** TM 9-1005-317-10

## 071-004-0004

### Unload an M9 Pistol

**Conditions:** Given an M9 pistol loaded with rounds.

**Standards:** Correctly remove the magazine and ammunition from the pistol; remove all rounds from the magazine; and ensure that the pistol safety lever is in the SAFE position.

**WARNING**

The M9 pistol will fire in the single- or double-action mode. With the safety in the FIRE position, squeezing the trigger automatically cocks and fires the pistol. This is the double-action mode of firing the pistol. Keep your finger away from the trigger unless you intend to fire.

1. Remove the magazine and the ammunition from the pistol.
  - a. Place the safety lever in the SAFE position.
  - b. Depress the magazine release button, and remove the magazine from the pistol.
  - c. Point the pistol in a safe direction (usually at the target or skyward).
  - d. Retract the slide fully to remove the chambered cartridge.
  - e. Lock the slide to the rear using the slide stop. Visually inspect the chamber to make sure it is empty.
  - f. Release the slide. Ensure that the safety lever is in the SAFE position.
2. Remove the ammunition from the magazine.
  - a. With one hand, hold the magazine upright, front end forward. With your thumb, firmly press down on the cartridge rim, and push forward. As the cartridge moves forward, tip the forward end of it up and out with your index finger.
  - b. Repeat the above steps until the magazine is empty.

**Evaluation Preparation:** *Setup:* At the test site, provide the equipment listed in the task conditions statement. Use dummy rounds to evaluate this task.

*Brief Soldier:* Tell the Soldier to unload the M9 pistol and remove all ammunition from the magazine.

Performance Measures	GO	NO GO
1. Removed the magazine and ammunition from the pistol.	___	___
2. Removed ammunition from the magazine.	___	___

**Evaluation Guidance:** Refer to chapter 1, paragraph 1-9e, (1) and (2).

**References**

**Required:**

**Related:** TM 9-1005-317-10

---

# 071-004-0005

## Correct Malfunctions of an M9 Pistol

**Conditions:** Given an M9 pistol; a loaded magazine with 9-mm ammunition; cleaner, lubricant, and preservative (CLP); lubricating oil arctic weather (LAW); lubricating oil, semifluid, automatic weapon (LSA); bore brush; wiping rags; M4 cleaning rod (handle with one section and a swab holder); and small arms cleaning swabs.

**Standards:** Without damage to the pistol, eliminate malfunctions caused by faulty action of either the pistol or the ammunition while in an environment that requires engaging targets.

### Performance Steps

#### WARNING

Always keep the pistol pointed in a safe direction during the following procedures.

1. Perform immediate action.

a. When the slide is fully forward and the pistol fails to fire, apply immediate action as follows:

- (1) Ensure that the safety lever is in the FIRE position.
- (2) Squeeze the trigger again.
- (3) If the pistol does not fire, ensure that the magazine is fully seated, and then retract the slide to the rear, and release.
- (4) Squeeze the trigger.
- (5) If the pistol still does not fire, remove the magazine and retract the slide to eject the chambered cartridge. Insert a new magazine, retract the slide, and release to chamber another cartridge.
- (6) Squeeze the trigger.
- (7) If the pistol does not fire, replace the ammunition.
- (8) If the pistol fails to fire again, clear the pistol and perform

remedial action according to step 2.

b. When the slide is not fully seated forward, remove the finger from the trigger. With the other hand, try to push the slide fully forward. If the slide will not move forward, proceed as follows:

- (1) Place the safety lever in the SAFE position.
- (2) Remove the magazine.
- (3) Grasp the slide and retract it to the rear, locking it with the slide

stop.

- (4) Inspect the chamber and remove any obstructions.
- (5) Insert another loaded magazine into the pistol.
- (6) Release the slide.
- (7) Place the safety lever in the FIRE position, aim, and squeeze the

trigger.

- (8) If the pistol does not fire, clear the pistol and perform remedial action according to step 2.

## Performance Steps

2. Perform remedial action.
  - a. Ensure that the pistol is clear.
  - b. Disassemble the pistol and inspect for dirty, corroded, missing, or damaged parts.
  - c. Clean dirty or corroded parts. Replace missing or damaged parts.
  - d. Lubricate and assemble the pistol.
  - e. Inspect the magazine for damaged parts. Replace the magazine if necessary.
  - f. Check for dirty or damaged ammunition. Clean or replace the ammunition.
  - g. Perform a function check.
  - h. Load the pistol and try to fire.
  - i. If the pistol does not fire, clear the pistol and notify your supervisor.

**Evaluation Preparation:** *Setup:* Provide equipment and materials listed in the task conditions statement. Use performance steps in the training outline to evaluate performance of the task.

*Brief Soldier:* Tell the Soldier the pistol stopped firing and to perform immediate and remedial action on the pistol.

Performance Measures	GO	NO GO
1. Performed immediate action.	_____	_____
2. Performed remedial action.	_____	_____

**Evaluation Guidance:** Refer to chapter 1, paragraph 1-9e, (1) and (2).

### References

#### Required:

**Related:** TM 9-1005-317-10

## 071-004-0006

### Engage Targets with an M9 Pistol

**Conditions:** Given an M9 pistol and one or more magazines loaded with 9-mm ammunition.

**Standards:** Apply the correct M9 target engagement techniques and engage hostile targets.

## Performance Steps

1. Identify the target(s). The most likely target you will engage is an enemy soldier on foot.

## Performance Steps

### 2. Apply the fundamentals of quick fire.

**Note:** To fire quickly without using the pistol sights, use the pistol as an extension of your arm.

- a. To use the pistol grip, hold the pistol in your nonfiring hand. Form a "V" with the thumb and forefinger of your firing hand.
- b. Place the pistol in the "V" with the sights in line with your firing arm.
- c. Hold your upper arm close to your body, and your forearm at about a 45-degree angle.
- d. Wrap your lower three fingers around the grip, putting equal pressure to the rear with all three fingers (figure 071-004-0006-1).
- e. Place your thumb alongside the pistol without applying any pressure.
- f. Place your trigger finger on the trigger so that it can be pulled to the rear.
- g. Tightly grip the pistol until your hand begins to tremble. Relax until the trembling stops. At this point, you have applied the necessary pressure for a solid grip.



**Figure 071-004-0006-1. Pistol ready position, one-handed grip**

**Note:** If you relax any of your three fingers on the grip, you must reapply the entire grip.

### 3. Choose one of the following supported or unsupported grips:

- a. Supported grip. The only supported grip is the one-hand grip (figure 071-004-0006-2). Begin by gripping the weapon as described. Allow the thumb of your firing hand to rest without pressure beside your weapon. Place your trigger finger, between the tip and the second joint, on the trigger, so you can squeeze the trigger to the rear. Your trigger finger must work independently of your other fingers.



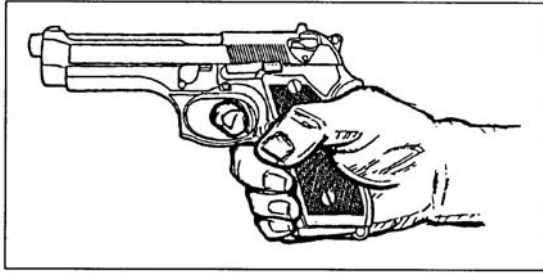

Figure 071-004-0006-2. One-hand grip

b. Unsupported grips. You may use any of three nonfiring hand grips to support your firing hand (figures 071-004-0006-3, 071-004-0006-4, and 071-004-0006-5).

(1) Fist grip (figure 071-004-0006-3). Begin by gripping the weapon as previously described. Firmly close the fingers of your nonfiring hand over the fingers of your firing hand. Make sure the index finger of your nonfiring hand is between the middle finger of your firing hand and the guard. Place your nonfiring thumb beside your firing thumb.

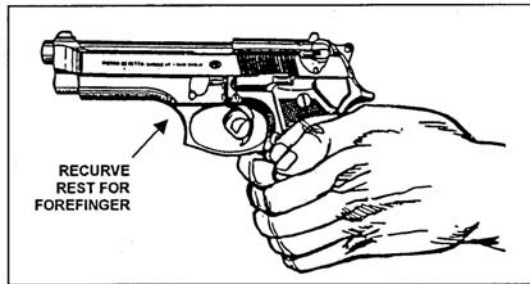

Figure 071-004-0006-3. Fist grip

*Note:* The M9 pistol has a recurved trigger guard, which allows you to place the index finger of your nonfiring hand on the front of the trigger guard if you wish.

(2) Palm-supported grip (figure 071-004-0006-4). Begin by gripping the weapon as previously described. Place your nonfiring hand under your firing hand. Wrap your nonfiring fingers around the back of your firing hand. Place your nonfiring thumb over the middle finger of your firing hand.

---

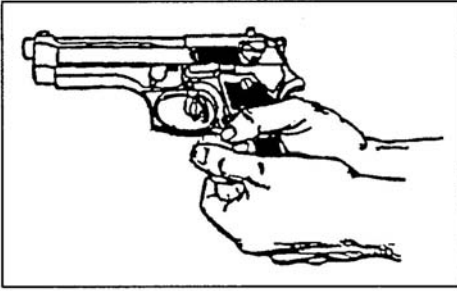

Figure 071-004-0006-4. Palm-supported grip

(3) Weaver grip (figure 071-004-0006-5). Apply this grip the same as the fist grip, but wrap your nonfiring thumb over your firing thumb.

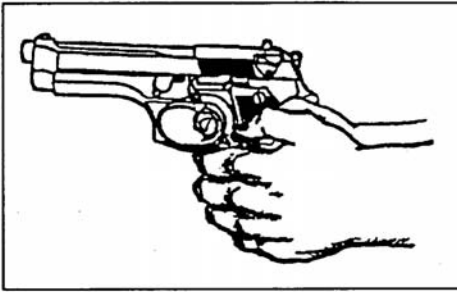

Figure 071-004-0006-5. Weaver grip

4. Select the most stable firing position with the best cover. Consider the following positions:

- a. Prone position (figure 071-004-0006-6). To assume the prone position—
  - (1) Lie flat on the ground, facing the target.
  - (2) Extend your arms to the front with your firing arm locked.
  - (3) Wrap your nonfiring hand around either the wrist or the fingers of your firing hand.
  - (4) Face forward. Keep your head down between your arms and behind the weapon.



Figure 071-004-0006-6. Prone position

## Performance Steps

b. Standing-with-support position (figure 071-004-0006-7). To assume this position—

- (1) Use available cover for support. For example, stand behind a tree or a wall.
- (2) Stand behind a barricade with your firing side in line with the edge of the barricade.
- (3) Place the palm of your nonfiring hand at eye level on the edge of the barricade, and extend your thumb past the edge of the barricade.
- (4) Lock the elbow of your firing arm. Rest your forearm on the extended thumb of your nonfiring hand.
- (5) Move the foot on your nonfiring side forward until your toe touches the bottom of the barricade.

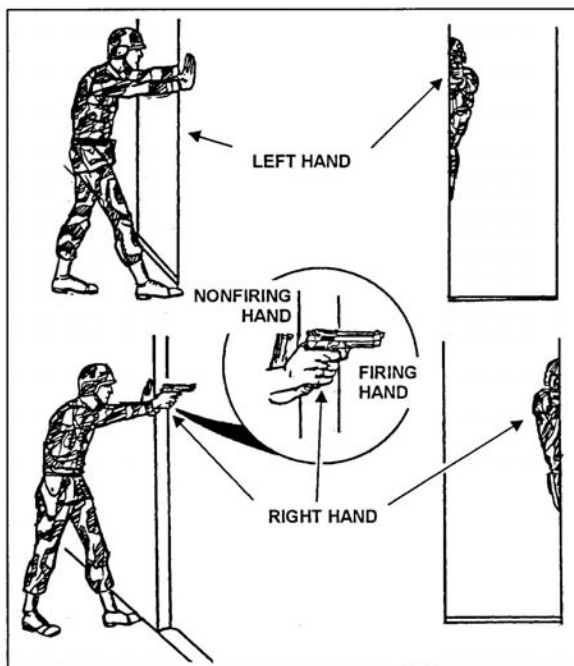

Figure 071-004-0006-7. Standing-with-support position

c. Kneeling (figure 071-004-0006-8). To assume this position—

- (1) Use available cover for support such as a low wall, rocks, or a vehicle that you can fire over.
- (2) Place your firing knee on the ground. Put your left knee down to fire left handed, or your right knee down to fire right handed.
- (3) Bend your other knee. Place the foot on your nonfiring side flat on the ground, pointing toward the target. Extend your arms over available cover, and use it for support.
- (4) Lock the wrist and elbow of your firing arm.

## Performance Steps

(5) Wrap your nonfiring hand around your firing fist or wrist to support your firing arm.

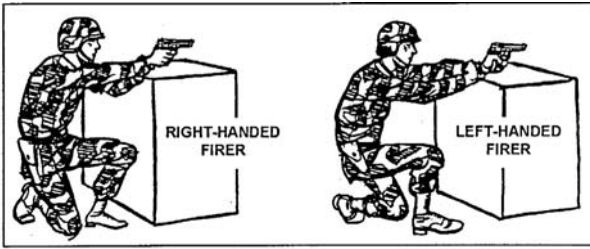
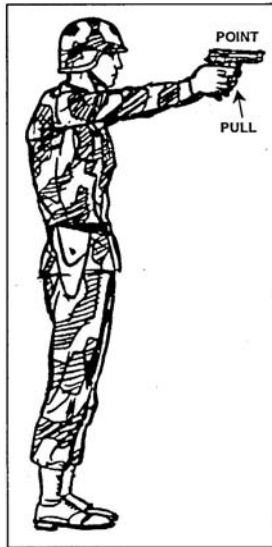

**Figure 071-004-0006-8. Kneeling position**

*Note:* This position could silhouette you, making you a better target. When possible, fire around the sides of walls, rocks, or vehicles instead of over them.

d. Standing-without-support position (figure 071-004-0006-9). To assume this position—

- (1) Face the target.
- (2) Place your feet at a comfortable distance apart.
- (3) Wrap your nonfiring hand around the fist or wrist of your firing hand. Lock the wrist and elbow of your firing arm toward the target.
- (4) Keep your body straight.



**Figure 071-004-0006-9. Standing-without-support position**

e. Crouching (figure 071-004-0006-10). This position is the same as the standing-without-support position, except you must bend your knees slightly. Balance by leaning forward at the waist.

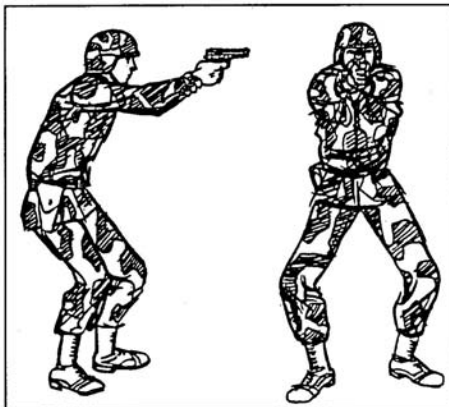

Figure 071-004-0006-10. Crouching position

5. Apply the fundamentals of marksmanship.
  - a. Pistol grip. To obtain a proper pistol grip—
    - (1) Place the pistol in the "V" formed by the thumb and forefinger of your firing hand. Line the sights up with your firing arm. Wrap your lower three fingers around the pistol. Grip with your middle finger under the trigger guard. Exert equal pressure on all three lower fingers to the rear, back through the wrist and forearm (Figure 1).
    - (2) Rest your thumb on top of your middle finger when gripping the pistol. Do not exert any downward pressure.
    - (3) Grip the pistol firmly, but not so firmly that your hand trembles.
  - b. Sight alignment. To sight properly—
    - (1) Align the front sight blade in the rear sight notch so that an equal amount of light shows on either side of the front sight. Ensure that the tops of the front and rear sights are even.
    - (2) Relax as much as possible.
    - (3) Maintain the correct sight alignment, and focus on the front sight.
    - (4) Squeeze the trigger with a steadily increasing pressure straight to the rear, taking care not to disturb the sight alignment until after the hammer falls.

**Note:** When there is more than one target, choose the target that is the greatest danger. This is often the closest target.

**Evaluation Preparation:** *Setup:* Evaluate this task during daylight on a 9-mm combat pistol qualification course. Provide the Soldier with 8 magazines and 52 rounds of live ammunition.

*Brief Soldier:* Tell the Soldier to use his/her own pistol and that he/she must hit 25 of the 30 targets using the correct engagement techniques.

Performance Measures	GO	NO GO
1. Assumed the firing positions.	___	___
a. Assumed the prone position.		
b. Assumed the standing-with-support position.		
c. Assumed the standing-without-support position.		
d. Assumed the kneeling position.		
e. Assumed the crouching position.		
2. Applied the fundamentals of marksmanship.	___	___
3. Engaged the targets:	___	___
a. From the prone position.		
b. From the standing-with-support position.		
c. From the standing-without-support position.		
d. From the kneeling position.		
e. From the crouching position.		

**Evaluation Guidance:** Refer to chapter 1, paragraph 1-9e, (1) and (2).

**References**

**Required:**

**Related:** FM 3-23.35 and TM 9-1005-317-10

**SUBJECT AREA 19: CASUALTY REPORTING AND HANDLING**

**101-515-1997**

**Inter Isolated Remains (After Receiving Authorization)**

**Conditions:** In a tactical situation given authorization from the responsible commander, isolated remains, an entrenching tool, human remains pouch, or shrouding material personal effects bag, a global positioning system (GPS), area map, DD Form 1076 (*Military Operations Record of Personal Effects of Deceased Personnel*) and DD Form 1079 (*Interment/Disinterment Register*), JP 4-06, and a metal stake to mark the site

**Standards:** Inter isolated remains according to JP 4-06.

**Performance Steps**

1. Prepare a burial site large enough to accommodate the human remains to be interred.
  - a. Attempt to locate the grave near the scene of death.
  - b. Inter on high ground away from a water source.

**Performance Steps**

- c. Dig the grave approximately 3 feet deep, 7 feet long, and 2 feet wide.
  - 2. Prepare the human remains for interment.
    - a. Inventory all personal effects found on the remains using DD Form 1076 or a blank sheet of paper.
    - b. Record the name, rank, social security number (SSN), and person(s) conducting the interment on DD Form 1079 or on a blank sheet of paper.
- Note:* If any of the above data cannot be determined, annotate "unknown" in the appropriate space.
- c. Place all personal effects and identification media in a sealed container and place on the remains.
  - d. Shroud the remains using a human remains pouch, poncho, or other suitable material.
  - 3. Inter individual remains.
    - a. Place the remains face up in the grave.
    - b. Refill the grave.
    - c. Mark the head of the grave using stacked rocks, metal stake, or other available item.
  - 4. Using a GPS, if possible, determine the location of the interment and record the 10-digit grid coordinates on DD Form 1079 or a blank sheet of paper.
  - 5. Submit all documents to higher headquarters, along with an incident report containing all relevant information pertaining to the interment.

**Evaluation Preparation:** Use a predetermined site and provide the Soldier with the required material to perform the task. Use a mannequin for training purposes and tell the Soldier to treat the mannequin as if it were an actual fatality.

Performance Measures	GO	NO GO
1. Prepared a burial site large enough to accommodate the number of human remains to be interred.	_____	_____
a. Attempted to locate the grave near the scene of death.		
b. Interred on high ground away from a water source.		
c. Dug the grave approximately 3 feet deep, 7 feet long, and 2 feet wide.		
2. Prepared the human remains for interment.	_____	_____
a. Inventoried all personal effects found on the remains using DD Form 1076 or on a blank sheet of paper.		

Performance Measures	GO	NO GO
b. Recorded name, rank, SSN, and person(s) conducting the interment on DD Form 1079 or a blank sheet of paper.		
c. Placed all personal effects and identification media in a sealed container and placed on the remains.		
d. Shrouded the remains using a human remains pouch, poncho, or other suitable material.		
3. Interred the individual remains.	___	___
a. Placed the remains face up in the grave.		
b. Refilled the grave.		
c. Marked the head of the grave using stacked rocks, metal stake, or other available item.		
4. Used a GPS to determine the location of the interment and recorded the 10-digit grid coordinates on DD Form 1079 or on a blank piece of paper.	___	___
5. Submitted all documents to higher headquarters along with an incident report containing all relevant information pertaining to the interment.	___	___

**Evaluation Guidance:** Refer to chapter 1, paragraph 1-9e, (1) and (2).

### References

**Required:** JP 4-06

**Related:** FM 3-25.26

## 101-515-1998

### Evacuate Isolated Remains

**Conditions:** In a tactical situation given JP 4-06, transportation (vehicle or aircraft), tiedown straps, location of isolated remains to evacuate, a predetermined location to bring the remains, global positioning system (GPS), area map, human remains pouch, personal effects bag, litter, and any recovery documentation.

**Standards:** Evacuate isolated remains according to JP 4-06.

#### Performance Steps

1. Establish the assembly area.
  - a. Record the grid coordinates of the assembly area using a GPS, if available.
  - b. Secure the assembly area.



**Performance Steps**

- c. Move the human remains (feet first) to the assembly area to await transportation.
- d. Contact higher headquarters for transportation assets to evacuate the remains.

*Note:* The request for transportation to evacuate the remains should contain the number of remains and the location of the recovery site. Any available covered transportation assets may be used to evacuate the remains. However, fixed or rotary-wing aircraft are the preferred method to evacuate human remains.

- e. Guard the area to prevent loss of personal effects and equipment, and to keep unauthorized personnel away.
- f. Mark the landing zone if air evacuation is used.

**2. Evacuate the remains or portions of remains and personal effects.**

- a. Secure the remains in a vehicle or an aircraft.

*Note:* Remains are usually carried feet first. On vehicles and rotary-wing aircraft, load human remains feet first. However, on fixed-wing aircraft, load human remains head first with the head towards the front of the aircraft.

- b. Evacuate the remains to the nearest mortuary affairs facility.

**Evaluation Preparation:** Use a predetermined site and provide the Soldier with required equipment to perform the task. Inform the Soldier that a mannequin will be used for training purposes and to treat the mannequin as if it were an actual fatality.

Performance Measures	GO	NO GO
1. Established the assembly area.	_____	_____
a. Recorded the grid coordinates of the assembly area using a GPS, if available.		
b. Secured the assembly area.		
c. Moved the human remains feet first to a central location or assembly area to await transportation.		
d. Contacted higher headquarters for transportation assets to evacuate the remains.		
e. Guarded the area.		
f. Marked the landing zone if air evacuation was used.		
2. Evacuated the remains or portions of the remains and personal effects.	_____	_____
a. Secured the remains in a vehicle or an aircraft.		
b. Evacuated the remains to the nearest mortuary affairs facility.		

**Evaluation Guidance:** Refer to chapter 1, paragraph 1-9e, (1) and (2).

**References**

**Required:** JP 4-06

**Related:**

---

## 101-515-1999

### Recover Isolated Remains

**Conditions:** In a tactical situation given JP 4-06, DD Form 565 (*Statement of Recognition of Deceased*), DD Form 567 (*Record of Search and Recovery*), and DD Form 1074 (*Questionnaire of Local Inhabitants*), a recovery site, compass, paper, pen and pencil, global positioning system (GPS), shrouding material or human remains pouch, personal effects bag and/or zip lock bag, litter, a military map, and a vehicle.

**Standards:** Recover isolated remains according to JP 4-06.

#### Performance Steps

1. Prepare for movement to the recovery site.
  - a. Obtain a briefing from the team leader or noncommissioned officer in charge (NCOIC).
  - b. Perform preventative maintenance checks and services (PMCS) on vehicle(s) prior to movement.
  - c. Load the vehicle according to the load plan.
  - d. Perform a map reconnaissance of the route to the recovery site.
  - e. Determine the azimuth from your location to the recovery site.
  - f. Convert grid azimuth to a magnetic azimuth.
2. Move to the recovery site.
3. Search for and locate the human remains.
  - a. Search during daylight hours only.
  - b. Search with other team members
  - c. Question local inhabitants to gain information relevant to the loss using DD Form 1074 or a blank piece of paper.
  - d. Search open areas at double-arm intervals and heavily vegetated areas at single-arm or close intervals.
  - e. Mark the location of the human remains with a stake and cloth streamer.
  - f. Search a 100-meter area in each direction around the human remains in an attempt to locate additional human remains.
4. Recover the human remains.

**Performance Steps**

- a. Check the human remains for booby-traps and unexploded ordnance.
  - b. Establish tentative identification of the remains by reviewing identification media found on the human remains.
  - c. Interview anyone in the area that can visually identify the human remains and record information on DD Form 565 or a blank piece of paper.
  - d. Place personal effects and identification media found on the human remains in a personal effects bag or sealed container and place the personal effects bag or sealed container securely on the remains.
  - e. Record the believed-to-be (BTB) name of the deceased and other pertinent information regarding the recovery site on DD Form 567 or a blank piece of paper.
  - f. Gather all portions of human remains, dental appliances, teeth, and loose articles. Place each item in a separate container and write a sequential "P" number for each portion or "E" number for each personal effect on the container.
  - g. Place the the remains in a shroud, such as a human remains pouch, poncho, or other suitable material.
  - h. Place all portions of human remains and disassociated personal effects in the human remains pouch or shroud.
  - i. Unload all weapons and remove explosive ordnance from the human remains.
- Note:* Weapons are to be returned to the unit armorer.
- Note:* Record all serial numbers on DD Form 567 or annotate on a blank piece of paper.
- j. Transport all equipment (except weapons) with the human remains.
  - k. Notify the team leader or NCOIC that the human remains are ready for evacuation.

**Evaluation Preparation:** Use a predetermined site and provide the Soldier with the required material to perform the task.

Performance Measures	GO	NO GO
1. Prepared for movement to the recovery site.	_____	_____
a. Obtained a briefing from the team leader or NCOIC.	_____	_____
b. Performed PMCS on vehicle(s) prior to movement.	_____	_____
c. Loaded the vehicle according to the load plan.	_____	_____
d. Performed a map reconnaissance of the route to the recovery site.	_____	_____

Performance Measures	GO	NO GO
e. Determined the azimuth from your location to the recovery site.		
f. Converted grid azimuth to a magnetic azimuth.		
2. Moved to the recovery site.	___	___
3. Searched for and located human remains.	___	___
a. Searched during daylight hours only.		
b. Searched with other team members.		
c. Questioned local inhabitants to gain information relevant to the loss using DD Form 1074 or a blank piece of paper.		
d. Searched open areas at double-arm intervals and heavily vegetated areas at single-arm or close intervals.		
e. Marked the location of the human remains with a stake and cloth streamer.		
f. Searched a 100-meter area in each direction around the human remains in an attempt to locate additional human remains.		
4. Recovered the human remains.	___	___
a. Checked the human remains for booby traps and unexploded ordnance.		
b. Established a tentative identification of the remains by reviewing identification media found on the human remains.		
c. Interviewed anyone in the area that could visually identify the human remains using DD Form 565 or a blank piece of paper.		
d. Placed personal effects and identification media found on the human remains in a personal effects bag or sealed container and placed personal effects bag or sealed container securely on the remains.		
e. Recorded the BTB name of the deceased and other pertinent information regarding the recovery site on DD Form 567 or a blank sheet of paper.		

Performance Measures	GO	NO GO
<p><b>f.</b> Gathered all portions of human remains, dental appliances, teeth, and loose articles. Placed each item in a separate container and wrote a sequential "P" number for each portion or "E" number for each personal effect on the container.</p> <p><b>g.</b> Placed the remains in a shroud, such as a human remains pouch, poncho, or other suitable material.</p> <p><b>h.</b> Placed all portions of human remains and disassociated personal effects in the human remains pouch or shroud.</p> <p><b>i.</b> Unloaded all weapons and remove explosive ordnance from the human remains.</p> <p><b>j.</b> Notified the team leader or NCOIC that the human remains were ready for evacuation.</p>		

**Evaluation Guidance:** Refer to chapter 1, paragraph 1-9e, (1) and (2).

**References**

**Required:** JP 4-06

**Related:** FM 3-25.26

**SUBJECT AREA 20: DEFENSE MEASURES**

## 052-191-1361

### Camouflage Yourself and Your Individual Equipment

**Conditions:** Given load-carrying equipment (LCE), an individual weapon, a Kevlar® helmet with camouflage cover, grass, bushes, trees, pieces of the Lightweight Camouflage Screen System (LCSS), skin paint, and charcoal and/or mud. You are wearing a battle dress uniform (BDU).

**Note:** When this task is performed in a chemical, biological, radiological, and nuclear (CBRN) environment, there will be no change in standards due to mission-oriented protective posture (MOPP) 4.

**Standards:** Camouflage yourself and your individual equipment to prevent detection by visual, near infrared, infrared, ultraviolet, radar, acoustic, and radio sensors.

**Performance Steps**

**1.** Identify critical camouflage considerations. Incorporate an analysis of the following considerations:

**a.** Movement.

**Note:** Movement draws attention, and darkness does not prevent observation. The naked eye and infrared/radar sensors can detect movement.

## Performance Steps

- (1) Minimize movement.
- (2) Move slowly and smoothly when movement is necessary.

### b. Shape.

(1) Use natural or artificial materials to breakup shapes, outlines, and equipment.

(2) Stay in shadows when moving, if possible.

(3) Disguise or distort the shape of your helmet and your body with natural or artificial materials when conducting operations close to the enemy.

c. Light reflection. Cover or remove the following items to eliminate light reflection:

- (1) Mirrors.
- (2) Eye glasses.
- (3) Watch crystals.
- (4) Plastic map cases.
- (5) Starched uniforms.
- (6) Clear plastic garbage bags.
- (7) Dust goggles worn on top of helmets.
- (8) Cigarettes and pipes.
- (9) Red-filtered flashlights.

NOTE: Replace all red filters on flashlights with blue-green filters.

d. Color. Blend individual camouflage with the surroundings or, at a minimum, ensure that objects do not contrast with the background (figure 052-191-1361-1).

*Note:* Change camouflage, as required, when moving from one area to another. What works well in one location may draw fire in another.

## 2. Camouflage your exposed skin.

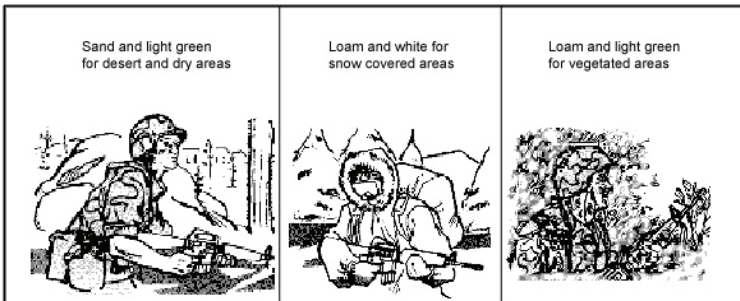

Figure 052-191-1361-1. Colors used for camouflage

*Note:* Exposed skin reflects light.

a. Cover your skin oils, using paint sticks, even if you have very dark skin.

## Performance Steps

*Note:* Paint sticks cover these oils and provide blending with the background.

*Note:* Do not use oils or insect repellent to soften paint sticks. This defeats the purpose of paint sticks by making the skin shiny. Work in pairs when applying paint, because self-application may leave gaps, such as behind the ears.

b. Use the color chart in table 052-191-1361-1 when applying paint on the face.

Table 052-191-1361-1. Color chart

Camouflage Material	Skin Color	Shine Areas	Shadow Areas
	Light or Dark	Forehead, Cheekbones, Ears, Nose, and Chin	Around Eyes, Under Nose, and Under Chin
Loam and Light Green Stick	All troops use in areas with green vegetation	Use loam	Use light green
Sand and Light Green Stick	All troops use in areas lacking green vegetation	Use light green	Use sand
Loam and White Stick	All troops use only in snow-covered terrain	Use loam	Use white
Burnt Cork, Bark Charcoal, or Lamp Black	All troops use if camouflage sticks are not available	Use	Do not use
Light-Color Mud	All troops use if camouflage sticks are not available	Do not use	Use

c. Paint high, shiny areas (forehead, cheekbones, nose, ears, chin) with a dark color.

d. Paint low, shadow areas with a light color.

e. Paint exposed skin on the back of the neck, arms, and hands with an irregular pattern.

### CAUTION

Mud contains bacteria, some of which is harmful and may cause disease or infection. Mud should be considered as a last resort for field expedient paint.

### CAUTION

Expedient paint containing motor oil should be used with extreme caution. Prolonged exposure to motor oil may result in personal injury.

3. Camouflage your BDU and helmet.

a. Roll your sleeves down, and button all buttons.

b. Attach leaves, grass, small branches, or pieces of LCSS to your uniform and helmet (figure 052-191-1361-2).

*Note:* These items will distort shapes and blend colors with the natural background.

*Note:* BDUs provide visual and near-infrared camouflage.

c. Do not starch BDUs because starch counters the infrared properties of the dyes in the BDUs.



Figure 052-191-1361-2. Camouflaged helmet

- d. Replace excessively faded and worn BDUs because camouflage effectiveness is lost.
4. Camouflage your personal equipment.
    - a. Cover or remove shiny items.
    - b. Secure items that rattle or make noise when moved or worn.

**Evaluation Preparation:** *Setup:* Ensure that all materials required in the conditions are available to the Soldier. The buddy system should be used when applying paint to the face.

*Brief Soldier:* Tell the Soldier, in preparation for unit defense, that he/she is to identify critical camouflage considerations, camouflage himself/herself or a buddy's exposed skin with paint sticks, and camouflage his/her individual equipment.

Performance Measures	GO	NO GO
1. Identified critical camouflage considerations.	___	___
2. Camouflaged your exposed skin.	___	___
3. Camouflaged your uniform and helmet.	___	___
4. Camouflaged your personal equipment.	___	___

**Evaluation Guidance:** Refer to chapter 1, paragraph 1-9e, (1) and (2).



## References

### Required:

Related: FM 20-3 and FM 21-75

---

## 071-000-0005

### Prepare a Range Card for a Machine Gun

**Conditions:** During daylight, in a defensive fighting position, given a tripod-mounted machine gun with a traversing and elevating (T&E) mechanism; an assigned primary sector of fire with recognizable targets (either an FPL [final protective line] or PDF [principal direction of fire]); a secondary sector of fire with recognizable targets; blank DA Forms 5517-R (*Standard Range Card*); a pencil; a lensatic compass; and a map of your assigned sector of fire.

**Standards:** Prepare a range card for your position in duplicate; sketch the terrain in your assigned sector of fire; locate and sketch magnetic north, using the appropriate symbol; and sketch sector limits, the gun symbol, an FPL or a PDF, and dead space. In the DATA SECTION, write the weapon, the unit, and other data; sketch terrain features that offer likely targets and number them in priority; and record the range and direction to and the elevation and description of each target.

#### Performance Steps

1. Show the gunner where to place fires on designated targets during limited visibility conditions such as night, fog, or smoke.
2. Provide the gunner conducting a relief in place with all the information he/she needs to respond immediately to enemy action.
3. Provide the platoon leader and company commander with information they need to plan fires.
4. Write all necessary information on the range card. Prepare a duplicate range card for the platoon leader. Include all sketches, symbols (figure 071-000-0005-1) and data on both copies.

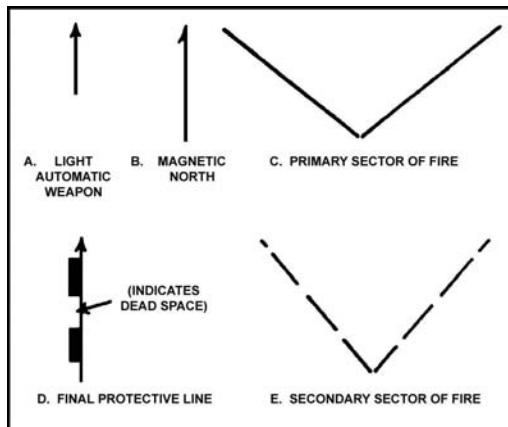

Figure 071-000-0005-1. Symbols

## Performance Steps

- a. On the range card, roughly sketch the terrain in front of the position.
  - (1) Center the machine gun position at the bottom of the sketch.
  - (2) Include any prominent natural and man-made features that a target could use to take cover.
- b. Using the lensatic compass, determine magnetic north.
- c. Write the following information in the top portion of the range card (figure 071-000-0005-2 and figure 071-000-0005-3):

STANDARD RANGE CARD					
For use of this form see FM 7-72. The proponent agency is TRADOC.					
SQUAD <u>2D</u>	May be used for all types of direct fire weapons.				MAGNETIC NORTH 
PLT <u>2D</u>					
CO _____					
DATA SECTION					
POSITION IDENTIFICATION <u>FL93668M4</u>				DATE <u>11 NOV</u>	
WEAPON <u>M60</u>			EACH CIRCLE EQUALS <u>100</u> METERS		
NO.	DIRECTION/DEFLECTION	ELEVATION	RANGE	AMMU	DESCRIPTION
1	<u>L035</u>	<u>0/24</u>	<u>400</u>		<u>PDF (ROAD JUNCTION)</u>
2	<u>R375</u>	<u>-90/15</u>	<u>625</u>		<u>BARN</u>
3	<u>R175</u>	<u>-90/40</u>	<u>725</u>		<u>HEDGE ROW</u>
REMARKS: ① TW 30/R7 ② TW 3/L3 ③ TW 7/R3					

Figure 071-000-0005-2. Primary sector with principal direction of fire

STANDARD RANGE CARD					
For use of this form see FM 7-72. The proponent agency is TRADOC.					
SQD <u>2<sup>D</sup></u>	May be used for all types of direct fire weapons.				MAGNETIC NORTH
PLT <u>2<sup>D</sup></u>					
CO _____					
DATA SECTION					
POSITION IDENTIFICATION			DATE <u>20 APRIL</u>		
WEAPON <u>M 60</u>			EACH CIRCLE EQUALS <u>100</u> METERS		
NO.	DIRECTION/DEFLECTION	ELEVATION	RANGE	AMMO	DESCRIPTION
<u>1</u>	<u>-</u>	<u>+50/3</u>	<u>550</u>		<u>FPL</u>
<u>2</u>	<u>R275</u>	<u>+20/45</u>	<u>525</u>		<u>BARN</u>
<u>3</u>	<u>L102</u>	<u>0/28</u>	<u>425</u>		<u>ROAD JUNCTION</u>
<u>4</u>	<u>L370</u>	<u>0/12</u>	<u>375</u>		<u>BOULDER</u>
REMARKS: <u>① - 4</u> <u>② TN 14/18</u>					

Figure 071-000-0005-3. Primary sector with final protection line

- (1) SQD. Write in the squad's designation.
- (2) PLT. Write in the platoon's designation.
- (3) CO. Write in the company's designation.
- (4) MAGNETIC NORTH. Sketch the direction for magnetic north using the symbol shown in B, figure 071-000-0005-1.

d. Determine the location of the gun position relative to a prominent terrain feature. You could use a hilltop, road junction, or building--in other words, use either a man-made or natural terrain feature.

- (1) Use any terrain feature located within 1,000 meters of the gun.
- (2) If no such feature exists, then, somewhere near the gun position on the sketch, write in the eight-digit map coordinates for your position (figure 071-000-0005-2).
- (3) Use a compass to determine the azimuth in mils or degrees from the terrain feature to the gun position or from the gun position to the terrain feature. Compute the back azimuth from the gun to the feature by adding or subtracting 3,200 mils or 180 degrees.
- (4) Determine the distance between the gun and the feature by pacing or looking at a map.
- (5) Draw the terrain feature in the lower left- or right-hand corner of the card, whichever better shows the terrain feature's position relative to the gun.

## Performance Steps

- (6) Draw a barbed line between the position and the terrain feature.
  - (7) Above the line, record the distance in meters.
  - (8) Below the line, record the azimuth in mils or degrees from the terrain feature to the gun.
  - (9) Use the direction of the arrow's barbs to show the direction of the azimuth.
- e. Sketch the primary sector of fire (C, figure 071-000-0005-1), using either a PDF or an FPL.
- (1) FPL. Use an FPL (figure 071-000-0005-3 DATA SECTION, Item No. 1) only if the position offers a good grazing distance. Base the primary sector of the line of fire. Make the FPL the sector limit closest to friendly troops.
    - (a) Sketch the limits of the primary sector of fire.
    - (b) Sketch an FPL (D, figure 071-000-0005-1) on the sector limit assigned by your leader.
      - (c) Have someone walk the FPL (if the enemy situation permits) to identify and measure dead spaces (section[s] of an FPL where a person drops below the light of sight).
      - (d) Show the dead space(s) on the sketch by a break(s) in the FPL symbol. Write in the ranges to the beginning and end of each dead space(s).
      - (e) Write in the maximum range of graze.
    - (2) PDF. If you cannot identify an FPL, you must assign a PDF (figure 071-000-0005-2 DATA SECTION, item No.1).
      - (a) Sketch the limits of the assigned primary sector of fire; the angle should not exceed 875 mils (the maximum traverse of a tripod-mounted machine gun).
      - (b) Sketch the symbol for a light automatic weapon (A, figure 071-000-0005-1). Orient the symbol toward the most dangerous target in the sector. (Get this information from the platoon leader.)
  - f. Label the targets in the primary sector in their order of priority. Label the FPL or PDF with the number "1" (figure 071-000-0005-2 and figure 071-000-0005-3).
  - g. Sketch the secondary sector of fire (E, figure 071-000-0005-1).
    - (1) Label the range (in meters) from the gun to each target in the secondary sector.
    - (2) Sketch aiming and elevation stakes between the gun position and the target as shown in figure 071-000-0005-2 and figure 071-000-0005-3.
5. Using the T&E mechanism, determine the direction, elevation, and range to each target. Write this information in the DATA SECTION of the range card as follows (figure 071-000-0005-2 and figure 071-000-0005-3):
- a. Center the traversing handwheel on the center mark.

## Performance Steps

b. If assigning an FPL, lay the gun for direction. (For this step, you will not write anything on the range card.)

(1) Lock the traversing slide on the extreme left or right side of the bar, depending on which side of the primary sector the FPL is on.

(2) Align the barrel on the FPL by moving the tripod legs.

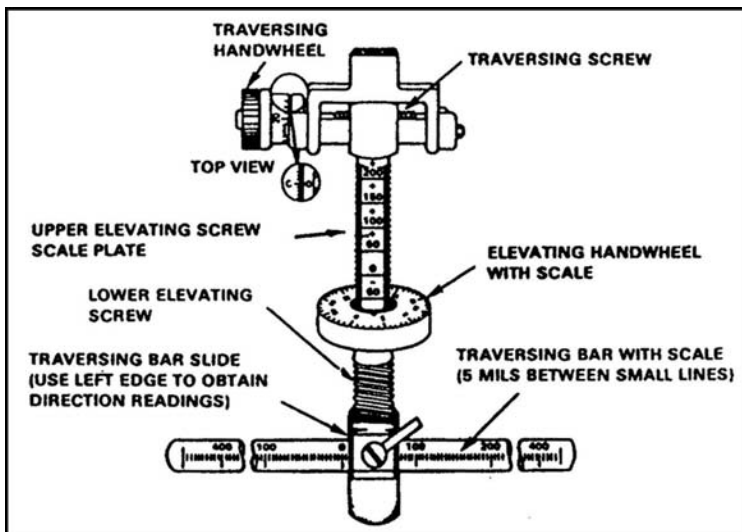

Figure 071-000-0005-4. Traversing and elevating mechanism

c. When assigned a PDF, lay the gun for direction.

(1) Align on the primary sector by traversing the slide to one side.

(2) Move the tripod to align the barrel on the sector limit.

(3) Align on the PDF by traversing the slide until the machine gun is aimed at the center of the target.

d. Fix the tripod legs in place by digging them in or sandbagging them.

e. Determine the direction to each target.

(1) Lay the gun on the base of the target.

(2) Read the direction on the traversing bar at the left edge of the traversing bar slide (figure 071-000-0005-4).

(3) Determine by the direction of the barrel whether the reading is right or left.

f. Determine the elevation for each target.

(1) Lay the gun on the base of the target by rotating the elevating handwheel (figure 071-000-0005-4).

(2) Read the number (including a "+" or "-" sign, unless the number is "0") above the first visible line on the elevating scale. (In figure 071-000-0005-4, this reading is "-50.")

## Performance Steps

- (3) Read, from the elevating handwheel, the number in line with the indicator. (In figure 071-000-0005-4, this reading is "3.")
6. Record the data you found using the T&E mechanism (figure 071-000-0005-4).
- Enter the reading in the ELEVATION column in the DATA SECTION of the range card, separating the two numbers with a slash.
  - Enter the range to each target in the appropriate column in the DATA SECTION.
  - Enter the description of each target in the appropriate column in the DATA SECTION.
  - Fill in the REMARKS block for each target as needed.
  - Enter the width and depth (in mils) of linear targets. The "-4" in figure 071-000-0005-3 REMARKS block means that depressing the barrel 4 mils will cause the strike of the rounds to go to ground level along the FPL.
  - When entering the target width (TW) in the REMARKS block, give the width in mils, and express it in two values. For example, in Figure 071-000-0005-2, Target 3 measures 7 mils wide. The second value, R3, means that if the gunner lays the gun on the target and traverses 3 mils to the right, the point of aim will lay to the right edge of the target. Target 3, Figure 071-000-0005-3, shows the width of the target as 15 mils; traversing 8 mils to the left will move the point of aim to the left edge of the target.
  - Do not determine data for the secondary sector of fire; the gunner will fire the weapon in the bipod mode.
7. Keep one copy of the range card at the machine gun position. Send the other copy to platoon headquarters. Complete range cards for primary positions. Partially prepare range cards for alternate and supplementary positions. Prepare the range card as soon as you arrive in a position, regardless of the expected length of stay. Continually revise the range card the entire time that you occupy the position.

**Evaluation Preparation:** *Setup:* Provide the Soldier with all the equipment needed to prepare a range card: pencil, paper, a stationary firing position, sector of fire, and target reference point designated.

*Brief Soldier:* Tell the Soldier to prepare only one copy of the range card for training purposes.

Performance Measures	GO	NO GO
1. Prepared the range card.	___	___
a. Sketched the terrain located in front of the position.	___	___
b. Determined the direction of magnetic north.	___	___

Performance Measures	GO	NO GO
c. Sketched the direction of magnetic north.	<input type="checkbox"/>	<input type="checkbox"/>
d. Completed the DATA SECTION.	<input type="checkbox"/>	<input type="checkbox"/>
e. Determined the location of the gun position relative to a prominent terrain feature.	<input type="checkbox"/>	<input type="checkbox"/>
f. Sketched the primary sector of fire using either a PDF or an FPL.	<input type="checkbox"/>	<input type="checkbox"/>
g. Labeled the targets.	<input type="checkbox"/>	<input type="checkbox"/>
h. Sketched the secondary sector of fire.	<input type="checkbox"/>	<input type="checkbox"/>
2. Used the T&E mechanism, determined the direction, elevation, and range.	<input type="checkbox"/>	<input type="checkbox"/>
a. Centered the traversing handwheel.	<input type="checkbox"/>	<input type="checkbox"/>
b. Laid the gun for direction.	<input type="checkbox"/>	<input type="checkbox"/>
c. Adjusted the tripod legs.	<input type="checkbox"/>	<input type="checkbox"/>
d. Read the direction to each target.	<input type="checkbox"/>	<input type="checkbox"/>
e. Read the elevation to each target.	<input type="checkbox"/>	<input type="checkbox"/>
3. Used the T&E mechanism to determine data for targets and then recorded it on the range card.	<input type="checkbox"/>	<input type="checkbox"/>
a. Entered the reading for elevation in the ELEVATION block in the DATA SECTION of the range card.	<input type="checkbox"/>	<input type="checkbox"/>
b. Entered the range to the target in the RANGE block in the DATA SECTION of the range card.	<input type="checkbox"/>	<input type="checkbox"/>
c. Described each target in writing.	<input type="checkbox"/>	<input type="checkbox"/>
d. Completed the REMARKS block for each target, as needed.	<input type="checkbox"/>	<input type="checkbox"/>

**Evaluation Guidance:** Refer to chapter 1, paragraph 1-9e, (1) and (2).

**References**

**Required:** FM 3-22.68

**Related:**

**071-326-0550**

**Prepare Positions for Individual and Crew-Served Weapons During an Urban Operation**

**Conditions:** As a firer or crewmember of a crew-served weapon, given a firing position within a building, sector of fire, and material to reinforce the position.

**Standards:** Prepare the position so you can place accurate fire on the enemy within the given sector of fire, with the least possible exposure to and greatest protection from return fire.

**Performance Steps**

*Note:* When a unit is defending in urban terrain, its success depends on the ability of Soldiers within the unit to place accurate fire on the enemy with the least possible exposure to return fire. Therefore, Soldiers must constantly seek and improve firing positions and use them properly.

1. Prepare individual rifle positions.

a. Barricade windows. Improve window firing positions by barricading around the windows (figure 071-326-0550-1). You can cover the window completely, except for a small hole to fire through. When barricading windows—

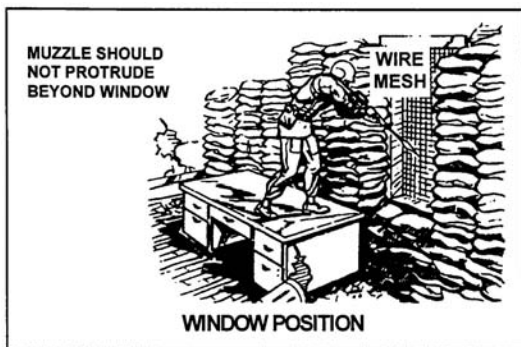

Figure 071-326-0550-1. Barricaded window

- (1) DO NOT barricade only the windows that you plan to use as firing positions. The enemy would figure that out in a hurry.
- (2) DO NOT form neat, square, or rectangular holes; the enemy will spot these, too.
- (3) Prepare barricades with sandbags, materials in the room or torn from the interior walls of the building, or other available material (figure 071-326-0550-2).



Figure 071-326-0550-2. Barricaded firing position



## Performance Steps

**Note:** Do not remove so much material from the interior wall that the building is weakened.

(4) Remove all glass from the window to prevent injury from flying glass.

(5) Leave curtains in place—they will let you see out but keep the enemy from seeing in.

(6) To keep dust from the muzzle blast from revealing your position, place a wet blanket over or wet down any dusty surfaces in front of the weapon's muzzle (figure 071-326-0550-3).

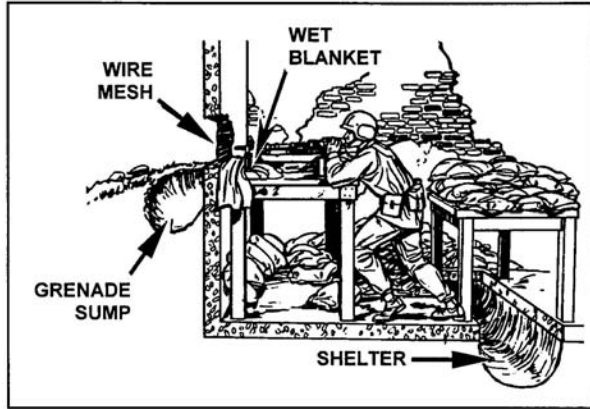

Figure 071-326-0550-3. Prepared automatic weapon position

b. Prepare loopholes. Windows usually make good firing positions, but they might not let you cover your full sector. Prepared loopholes give you alternate firing positions.

(1) Break or blow several small holes in the wall (Figure 071-326-0550-4) so you can observe and engage targets in your sector. Making several holes allows you to move from one to another to deceive the enemy about your location.

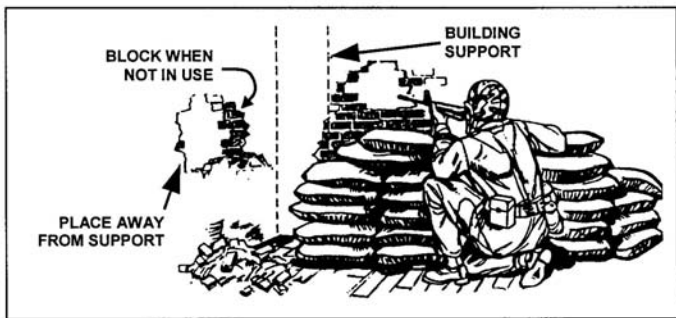
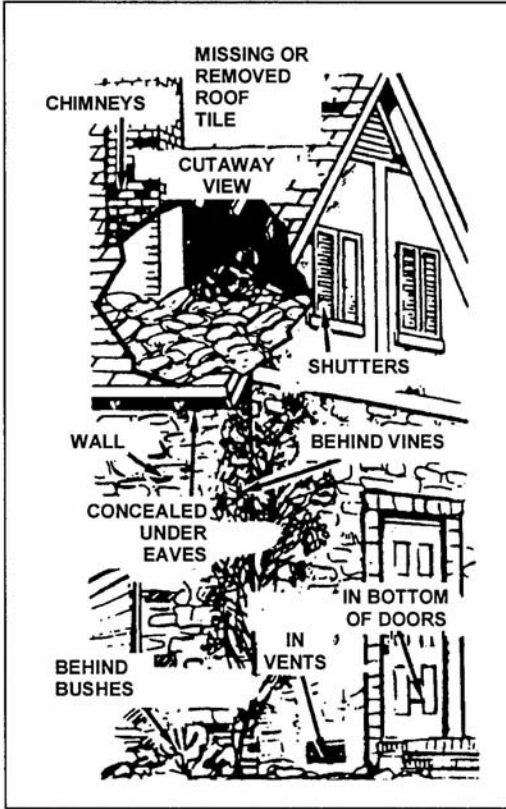

Figure 071-326-0550-4. Loophole position

**Performance Steps**

(2) Camouflage the loopholes by knocking other holes in the wall so the enemy cannot easily determine which one your fire is coming from (figure 071-326-0550-5).



**Figure 071-326-0550-5. Camouflage of loopholes**

(3) Use sandbags or other material to reinforce the walls around loopholes (figure 071-326-0550-6).

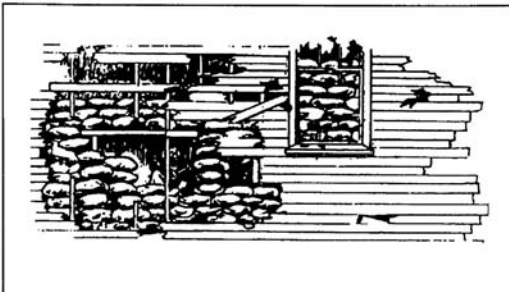

**Figure 071-326-0550-6. Reinforced loopholes**

## Performance Steps

(4) When reinforcing windows or loopholes, place two layers of sandbags on the floor under you. This protects you from an explosion on a lower floor when your position is on the second floor or higher. Use tables, bedsteads, or other available material to give yourself overhead cover from falling debris or from explosions above your position. You can build a blast wall to the rear of your position to protect you from explosions in the room (figure 071-326-0550-7).

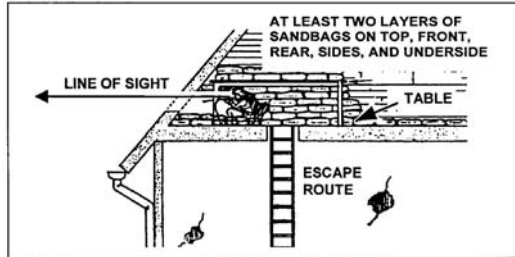

Figure 071-326-0550-7. Reinforced position

c. Prepare sniper positions.

(1) Sniper positions should be on or near the top of the building being defended to allow greater fields of fire (figure 071-326-0550-8).

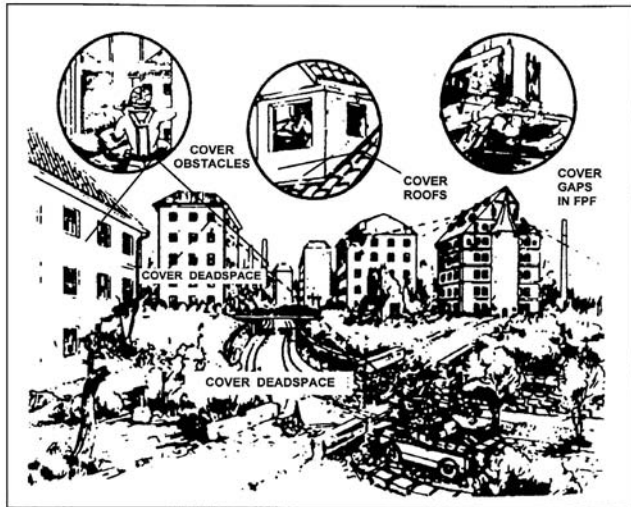

Figure 071-326-0550-8. Sniper positions

(2) A chimney or other structure protruding through the roof of a building provides a good base from which to prepare a sniper position. Remove part of the roofing material. Stand below roof level on a constructed platform. Only your head and shoulders should be above the roofline. This way you can fire around the chimney.

(3) You can use sandbags on the sides of the position to protect your flanks.

## Performance Steps

### 2. Prepare machine gun positions.

a. You can emplace a machine gun position in the same type of position as you would place a position for an individual firer, except that you should avoid windows and doors. The enemy will expect you to emplace weapons at these openings, so those locations would draw the most enemy fire. Since machine guns are less mobile than rifles, they are more difficult to move in case of heavy fires.

b. Emplace machine guns as low as possible, using loopholes behind shrubbery or under doorjamb. You can also use basement windows. By placing the machine gun at a lower level, you can fire grazing fire (figure 071-326-0550-9).

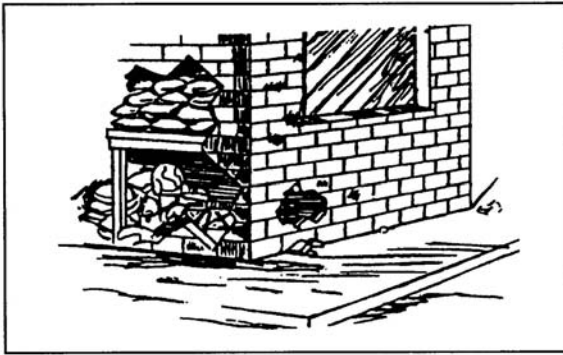

Figure 071-326-0550-9. Low machine gun position

c. Although grazing fire is desirable when employing the machine gun, it is impractical or impossible where destroyed vehicles, rubble, and other obstructions restrict your field of fire. In such cases, emplace the machine gun at a higher location such as loopholes on the second or third floor or in the roof (figure 071-326-0550-10).

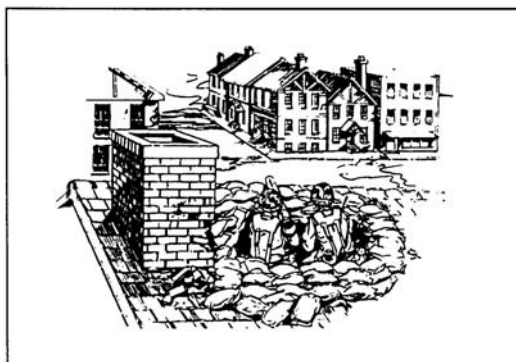

Figure 071-326-0550-10. High machine gun position

## Performance Steps

### 3. Prepare antitank weapons position.

a. Position the antitank weapons (tube launched, optically tracked, wire guided [TOW], Dragon, 90-mm, LAW) on upper stories for long-range coverage (figure 071-326-0550-11).



**Figure 071-326-0550-11. Antitank weapons placement**

*Note:* The maximum depression and elevation limits of the TOW mount plus the minimum firing distance (65 meters) can create a dead space and keep you from engaging close-in targets.

b. Consider backblast when choosing and preparing an antitank weapon location. You cannot fire any antitank weapon from an unvented or enclosed room.

c. When you can, avoid firing from inside a building. However, when you must do so—

- (1) Choose a sturdy building.
- (2) Ensure that the ceiling is at least 7 feet high.
- (3) Ensure that the room's floor size measures at least—
  - (a) TOW or AT4: 17 by 24 feet
  - (b) Dragon: 12 by 15 feet
  - (c) LAW: 4 feet to the back wall
- (4) Ensure that the clearance between the muzzle of the weapon and the opening it is fired from is—
  - (a) TOW: 9 inches
  - (b) Dragon: 6 inches
- (5) Also, ensure that there is an opening at least 20 feet square at the rear of each of these weapons to allow for backblast. An open 3- by 7-foot door is enough.
- (6) Remove all glass from windows and all loose objects from the room.

### Performance Steps

- (7) Ensure that all Soldiers in the room remain forward of the rear of the weapon.
  - (8) Ensure that all Soldiers in the room protect their ears when the weapon is fired.
- d. When emplacing the TOW and Dragon, consider the 65-meter minimum firing distance (arming distance).
  - e. Reinforce antitank weapon positions the same as described in this task for the individual rifle position, except that you need not erect a blast wall.

**Evaluation Preparation: Setup:** At the test site, provide all the materials and equipment listed in the task conditions statement.

**Brief Soldier:** Tell the Soldier to prepare an individual or crew-served weapon position.

Performance Measures	GO	NO GO
1. Prepared individual rifle positions.	___	___
2. Prepared the machine gun positions.	___	___
3. Prepared the antitank weapon positions.	___	___

**Evaluation Guidance:** Refer to chapter 1, paragraph 1-9e, (1) and (2).

### References

#### Required:

**Related:** FM 3-06 and FM 3-06.11

## 071-326-0557

### Select Hasty Firing Positions During an Urban Operation

**Conditions:** As a member of an attacking or defending unit in urban terrain, given a requirement to select hasty firing positions.

**Standards:** Select positions from which to place fire on the enemy while using available cover.

### Performance Steps

**Note:** The success of a mission depends on your ability to place accurate fire on the enemy with the least possible exposure to return fire. Therefore, you must constantly seek covered firing positions and use them properly.

1. Fire around a building or wall.
  - a. Fire around the left corner of the building or wall using the left-handed firing technique (figure 071-326-0557-1).



**Figure 071-326-0557-1. Firing around the left corner of a building**

- b.** Fire around the right corner of the building or wall using the right-handed firing technique (figure 071-326-0557-2).



**Figure 071-326-0557-2. Firing around the right corner of a building**

- c.** Use the prone firing technique, where possible.
  - d.** Fire around the wall, not over it, where possible (figure 071-326-0557-3).
-



Figure 071-326-0557-3. Firing around a wall

2. Fire from a window.

- a. Select firing positions that are well back from the window. They will help conceal your body and your rifle's muzzle (figure 071-326-0557-4).

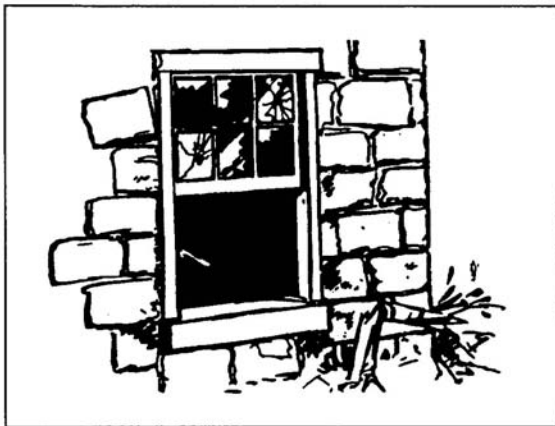

Figure 071-326-0557-4. Firing from a window

- b. Select a kneeling firing position. This will reduce your exposure and prevent silhouetting (figure 071-326-0557-4).

3. Fire from unprepared loopholes. Select firing positions well back from the loophole to conceal your muzzle flash (figure 071-326-0557-5).



## Performance Steps



Figure 071-326-0557-5. Firing from loophole

**Evaluation Preparation:** *Setup:* At the test site, provide all the materials and equipment given in the task conditions statement.

*Brief Soldier:* Tell the Soldier to select positions where he/she can place fire on the enemy while using available cover.

Performance Measures	GO	NO GO
1. Fired around a building or wall.	___	___
2. Fired from a window.	___	___
3. Fired from unprepared loopholes. Selected a position well back from the window.	___	___

**Evaluation Guidance:** Refer to chapter 1, paragraph 1-9e, (1) and (2).

### References

#### Required:

**Related:** FM 3-06 and FM 3-06.11

## 071-326-0608

### Use Visual Signaling Techniques

**Conditions:** Given a requirement to use visual signals while mounted.

**Standards:** Give the proper procedures for each required action.

#### Performance Steps

1. Ensure that the Soldiers you are signaling can see you.
2. Perform the visual signals for combat formations, battle drills, and movement techniques as follows:
  - a. Perform formation signals coil and herringbone (figure 071-326-0608-1 and figure 071-326-0608-2).

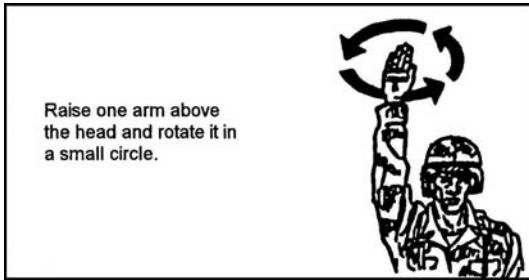

Figure 071-326-0608-1. Coil

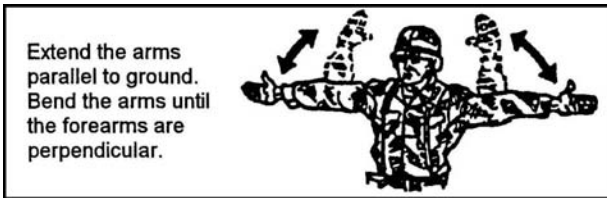

Figure 071-326-0608-2. Herringbone

b. Perform the following drill signals: Contact left, contact right, action right, action left, action front (right, left, or rear), air attack, and nuclear, biological, or chemical attack (figure 071-326-0608-3 through figure 071-326-0608-9).

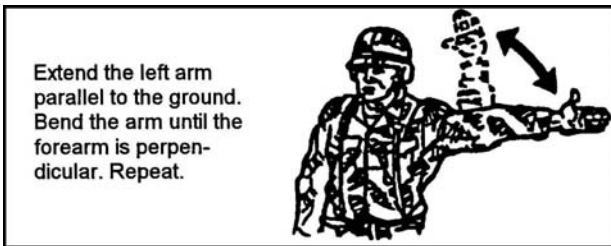

Figure 071-326-0608-3. Contact left

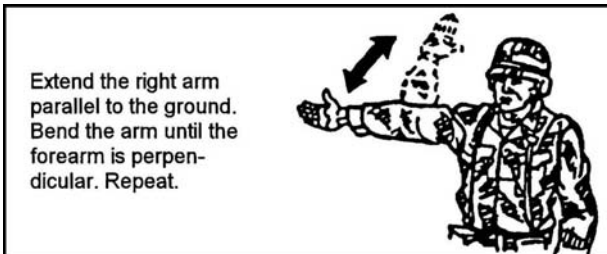

Figure 071-326-0608-4. Contact right



Figure 071-326-0608-5. Action left

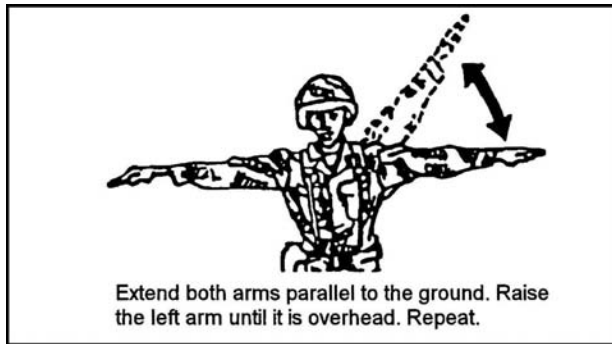

Figure 071-326-0608-6. Action right

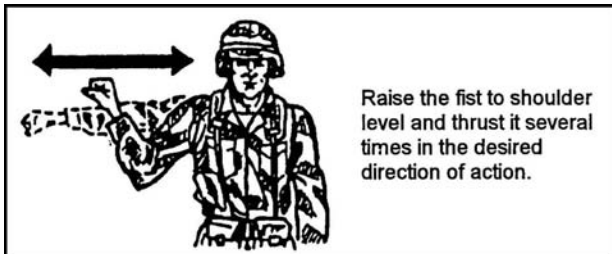

Figure 071-326-0608-7. Action front (right, left, or rear), fight on foot, or assault fire (dismounted troops)

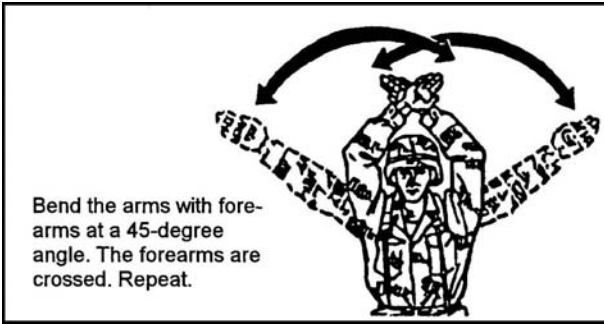

Figure 071-326-0608-8. Air attack

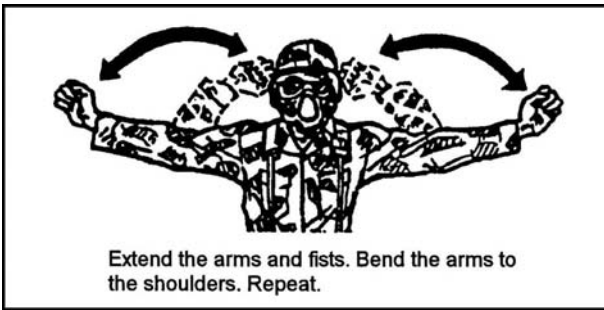

Figure 071-326-0608-9. Chemical, biological, radiological, and nuclear attack

c. Perform the following movement technique signals: Traveling, traveling overwatch, bounding overwatch (figure 071-326-0608-10 through figure 071-326-0608-12).

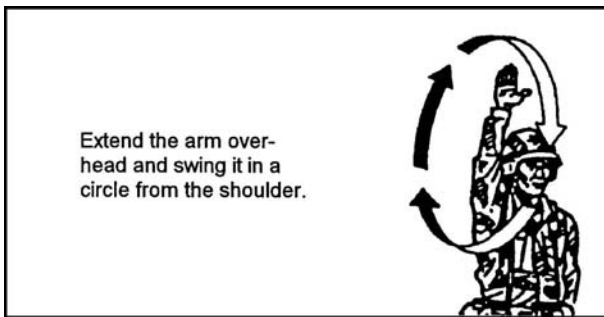

Figure 071-326-0608-10. Traveling

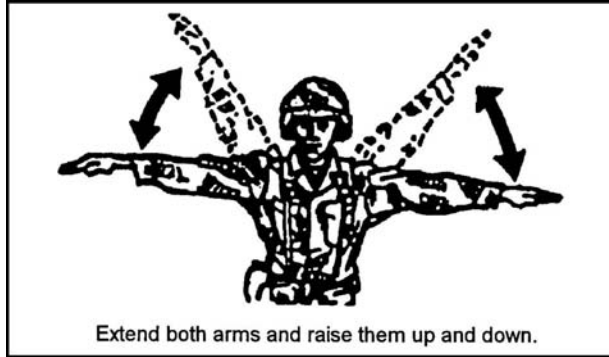

Figure 071-326-0608-11. Traveling overwatch

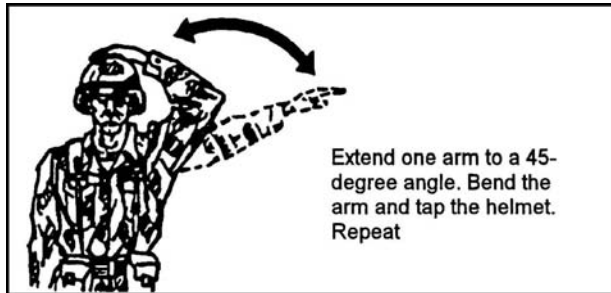

Figure 071-326-0608-12. Bounding overwatch, cover my move

d. Perform vehicle signals: Move to the left; move to the right; move forward; attention; I am ready, or ready to move, are you ready; mount; disregard previous command, or as you were; I do not understand; start engine or prepare to move; halt or stop; increase speed; advance or move out, open up; close up; right or left turn; slow down; move in reverse; close distance between vehicles and stop; stop engines; dismount; neutral steer, stop; button up or unbutton; and message acknowledged (figures 071-326-0608-13 through 071-326-0608-36).

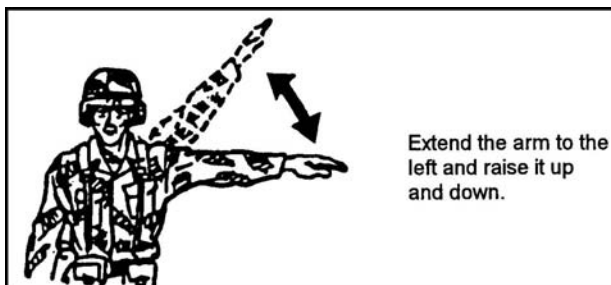

Figure 071-326-0608-13. Move to the left

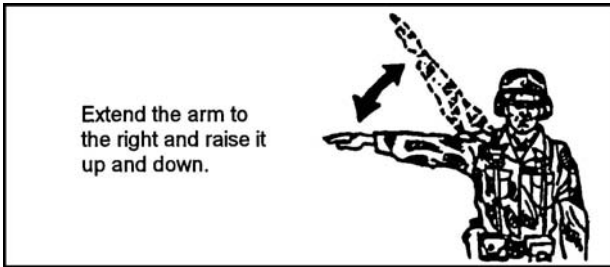

Figure 071-326-0608-14. Move to the right

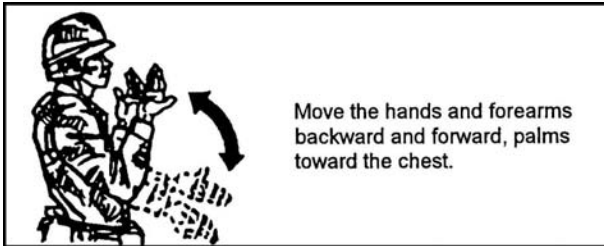

Figure 071-326-0608-15. Move forward

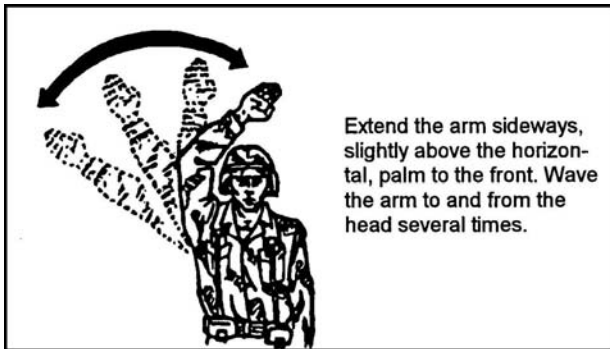

Figure 071-326-0608-16. Attention!

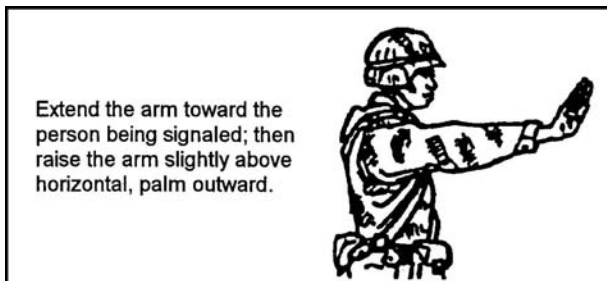

Figure 071-326-0608-17. I am ready, or Ready to move, are you ready?

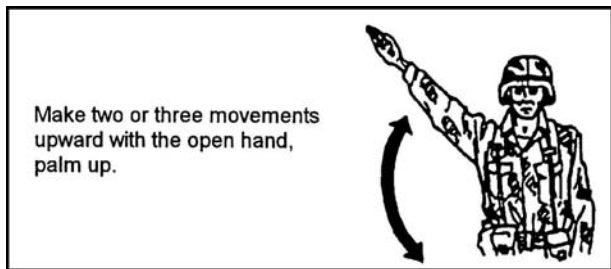

Figure 071-326-0608-18. Mount

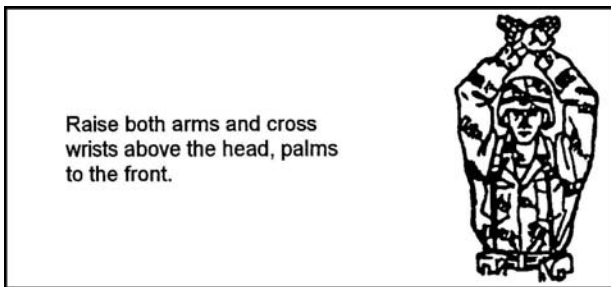

Figure 071-326-0608-19. Disregard previous command, or As you were

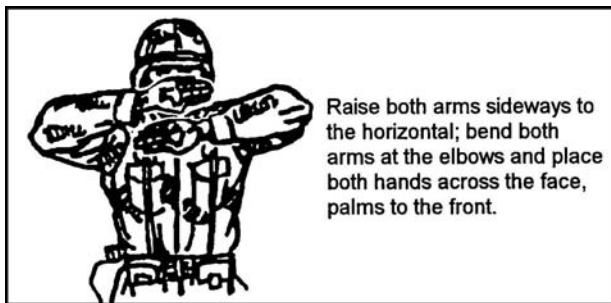

Figure 071-326-0608-20. I do not understand

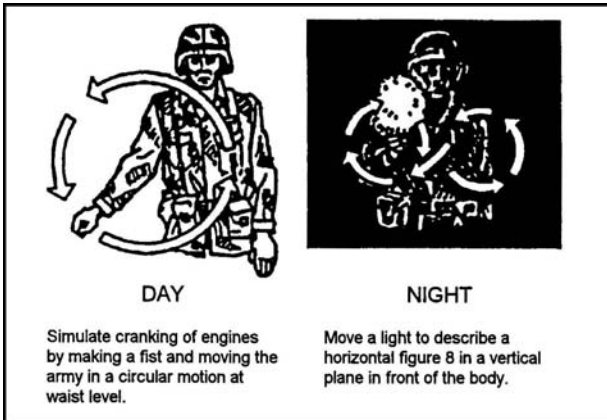

Figure 071-326-0608-21. Start engine, or Prepare to move

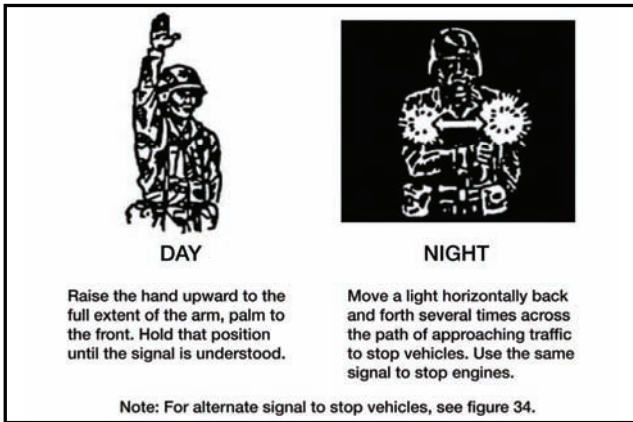

Figure 071-326-0608-22. Halt or stop



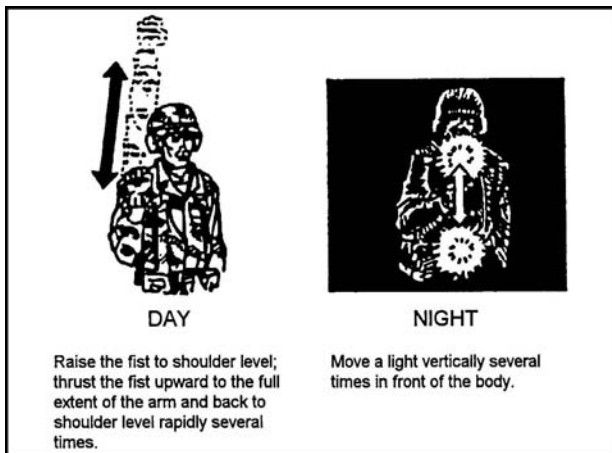

Figure 071-326-0608-23. Increase speed

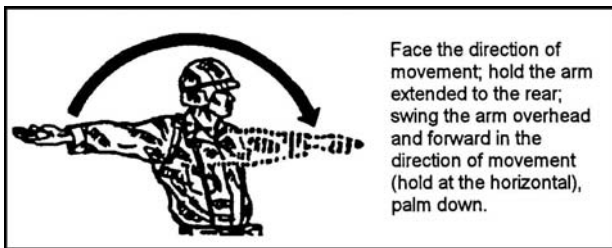

Figure 071-326-0608-24. Advance or move out

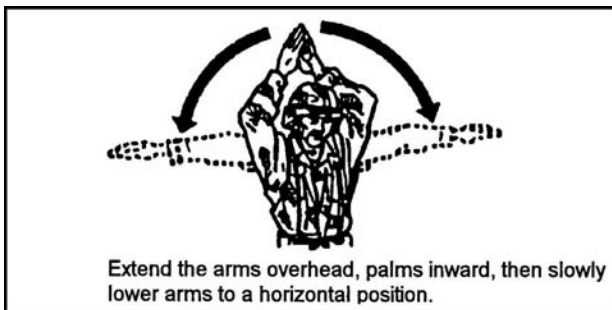

Figure 071-326-0608-25. Open up

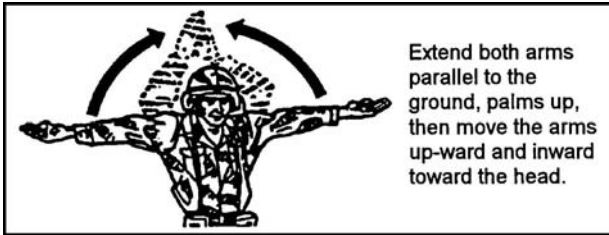

Figure 071-326-0608-26. Close up

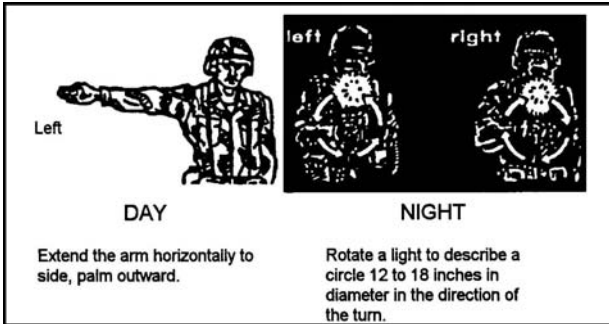

Figure 071-326-0608-27. Right or left turn

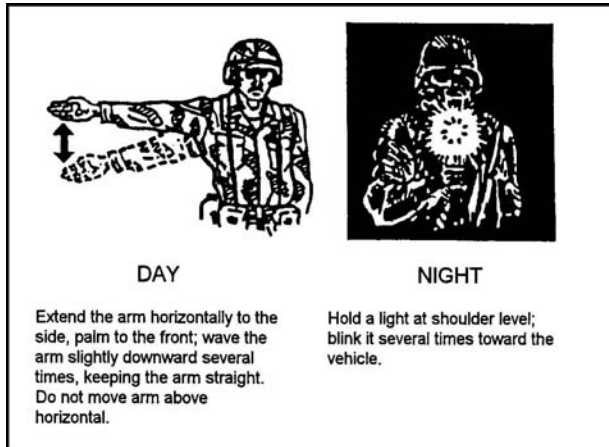

Figure 071-326-0608-28. Slow down

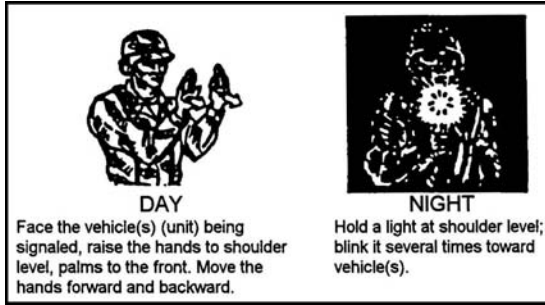

Figure 071-326-0608-29. Move in reverse (for stationary vehicles)



Figure 071-326-0608-30. Close distance between vehicles and stop

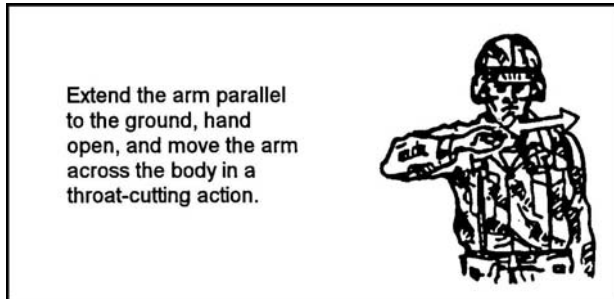

Figure 071-326-0608-31. Stop engines

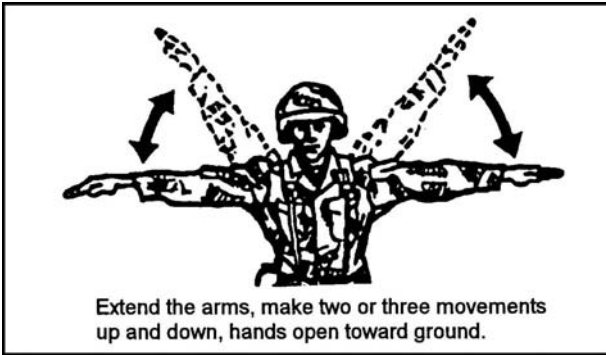

Figure 071-326-0608-32. Dismount

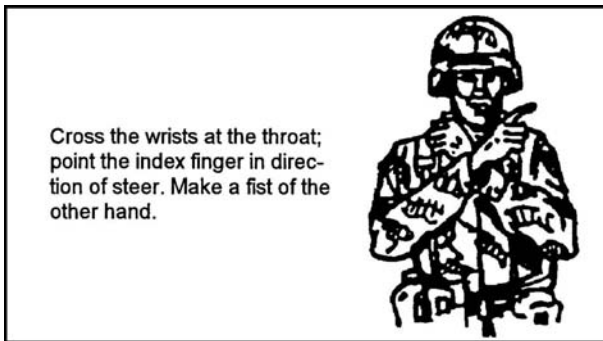

Figure 071-326-0608-33. Neutral steer (tracked vehicles)

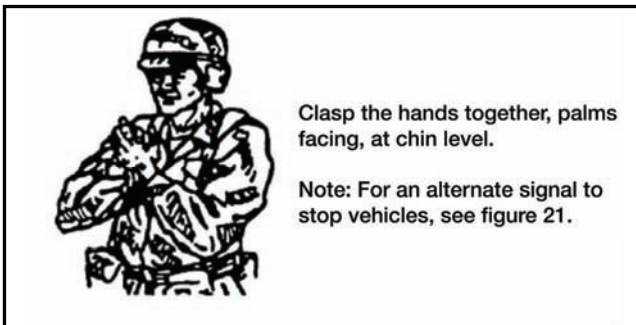

Figure 071-326-0608-34. Stop (alternate signal to stop tracked vehicle)

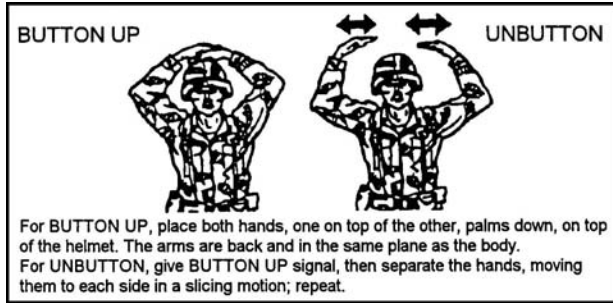

Figure 071-326-0608-35. Button up or unbutton

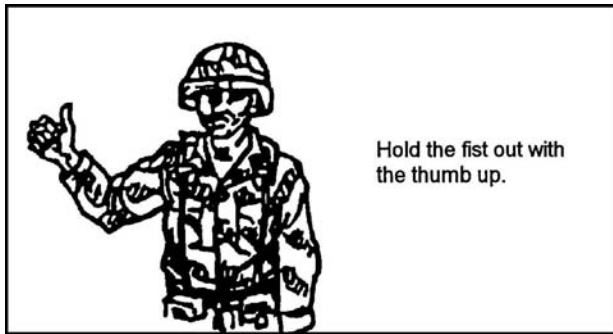

Figure 071-326-0608-36. Message acknowledged

3. Perform flag signals: Single signal flag; mount or dismount; dismount and assault; assemble or close; move out; and nuclear, biological or chemical hazard present (figure 071-326-0608-37 through figure 071-326-0608-43).



Figure 071-326-0608-37. Single signal flag

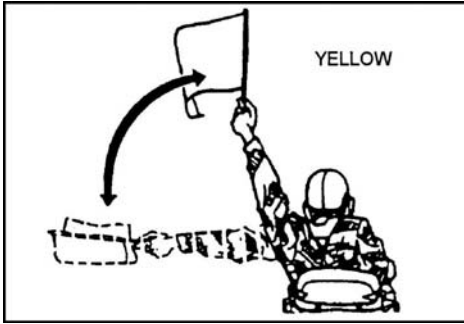

Figure 071-326-0608-38. Mount

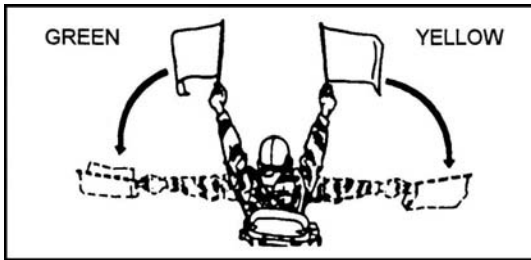

Figure 071-326-0608-39. Dismount

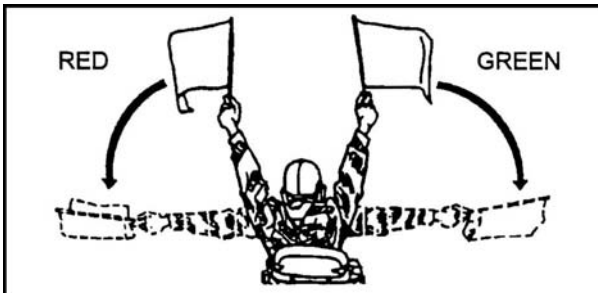

Figure 071-326-0608-40. Dismount and assault

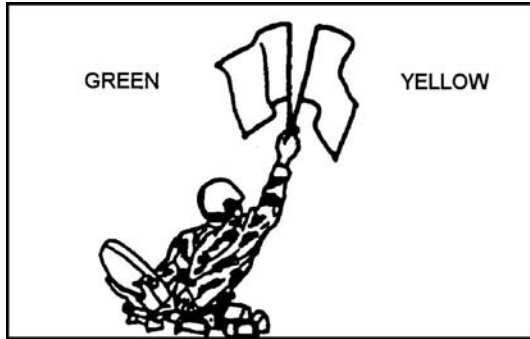

Figure 071-326-0608-41. Assemble or close

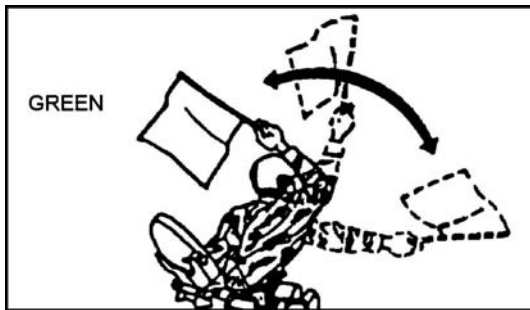

Figure 071-326-0608-42. Move out

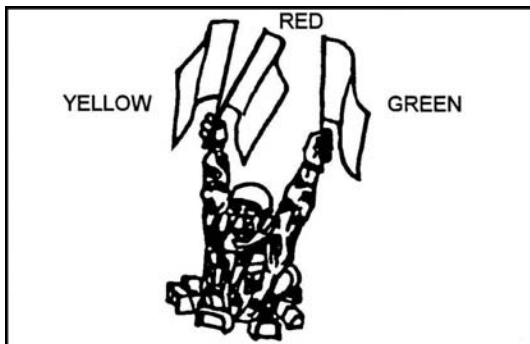

Figure 071-326-0608-43. Chemical, biological, radiological, and nuclear or hazard present

*Note:* When used alone, flag colors have the following meanings:

- Red—danger or enemy in sight.
- Green—all clear, ready, or understood.
- Yellow—disregard or vehicle out of action.

*Note:* In poor visibility, you can use colored chemical lights or flashlights with colored filters in place of flags.

**Evaluation Preparation:** *Setup:* At the test site, provide a set of vehicle-signaling flags and flashlight. From the signals shown in the task, pick 10 to test.

*Brief Soldier:* Tell the Soldier you will give the ten signals, and he/she must correctly execute each one.

Performance Measures	GO	NO GO
1. Executed proper formation signals.	___	___
2. Executed proper drill signals.	___	___
3. Executed proper movement technique signals.	___	___
4. Executed proper signals to control vehicle drivers and crews.	___	___
5. Executed proper flag signals.	___	___

**Evaluation Guidance:** Refer to chapter 1, paragraph 1-9e, (1) and (2).

**References**

**Required:**

**Related:** FM 17-95, FM 21-60, and FM 7-7

## 071-326-5703

### Construct Individual Fighting Positions

**Conditions:** Given load-carrying equipment (LCE) with bayonet, scabbard, entrenching tool, poncho, and M16A1 rifle; a specific location and sector of fire; and logs to construct overhead cover.

**Standards:** 1. Construct a hasty fighting position that gives frontal cover from enemy direct fire and allows you to fire to the front and oblique.

2. Construct a one-Soldier fighting position wide enough for you and your equipment, armpit deep, with frontal and overhead cover at least 18 inches deep, with grenade sumps, and with a floor sloped toward the sumps. Ensure that the position allows you to place fire on your assigned sector.

#### Performance Steps

*Note:* When you first move into battle, you might have little or no time to prepare a position.

1. Prepare a hasty fighting position.
  - a. Select a hasty fighting position that—
    - (1) Is behind whatever cover is available.
    - (2) Provides frontal protection.
    - (3) Allows you to shoot to the front and at an oblique angle.
    - (4) Is in a small depression or a hole at least 18 inches deep.

*Note:* The term "hasty position" does not preclude digging.

- b. In whatever time you have, improve your position by digging or scraping out a prone shelter that gives you some protection (figure 071-326-5703-1).





Figure 071-326-5703-1. Hasty fighting position

2. Prepare a one-Soldier fighting position (figure 071-326-5703-2).



Figure 071-326-5703-2. One-man fighting position

*Note:* This type of position allows flexibility in the use of cover. The hole need only be long enough for you and your equipment. You must be able to shoot to both the front and oblique from behind frontal cover. It does not provide the security that a two-Soldier position does.

- a. Obtain position location and sector of fire from your leader.
- b. Put in sector-of-fire stakes.
- c. Partially clear a field of fire within your sector.
- d. Dig a hasty hole for minimum protection, being careful not to destroy natural camouflage around your position.

## Performance Steps

- e. Save grass clumps for use as camouflage later.

**Note:** At this stage of construction of the position, you should be able to fight effectively in the event of a surprise attack.

- f. Dig in, shaping the hole to fit the natural cover available.

**Note:** Depending on the size and shape of the frontal cover that you are using, you may not be able to dig a rectangular hole.

- (1) Make the foxhole armpit deep (figure 071-326-5703-3).

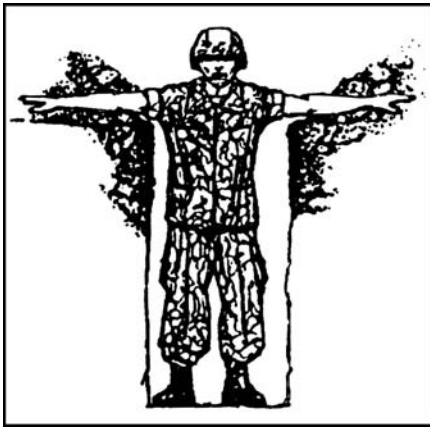

**Figure 071-326-5703-3. Fighting position armpit deep**

**Note:** Frontal cover is important so you can shoot without exposing your head to enemy fire. Ideally, you will have a natural parapet, such as a tree, mound, rock, or stump that will blend with the surrounding terrain available for frontal cover.

- (2) Use the dirt from your hole to build a parapet that—

- (a) Provides frontal cover with at least 45 centimeters (18 inches) of earth between you and the enemy if a natural parapet is not available.

- (b) Is high enough to cover your head.

- (c) Is far enough in front of the hole to allow for elbow rests and sector stakes.

- (3) Modify your position on steep terrain by digging out firing ports at each end of the hole so that the ground between the firing ports then serves as frontal cover for the position (figure 071-326-5703-4).

---



Figure 071-326-5703-4. Fighting position on slope

*Note:* On a steep slope, a Soldier in a hole behind frontal cover cannot shoot attackers without being exposed to enemy fire.

g. Save the remaining dirt for later use as flank, overhead, and rear cover (figure 071-326-5703-5).

---

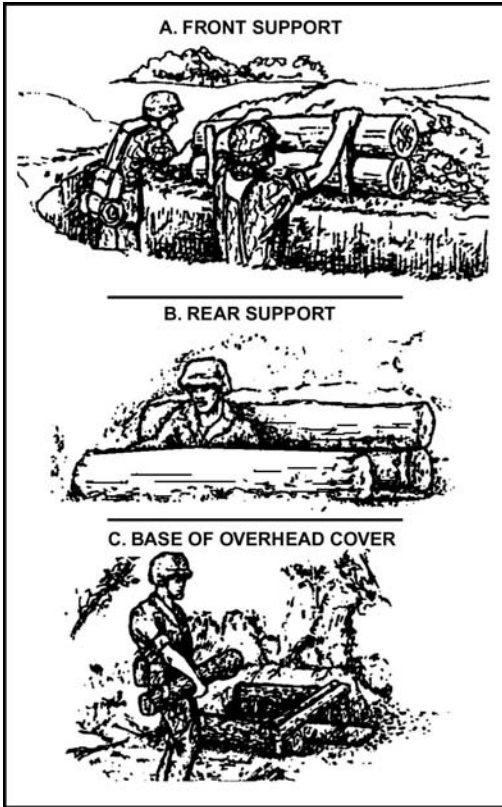

Figure 071-326-5703-5. Constructing overhead cover



Figure 071-326-5703-5. Constructing overhead cover (continued)

- h. Dispose of excess dirt.
  - (1) Carry it away from your position.
  - (2) Camouflage it.
- i. Dig two trench-shaped grenade sumps (figure 071-326-5703-6).

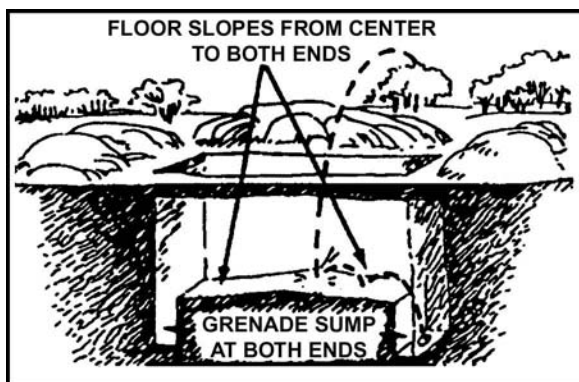

Figure 071-326-5703-6. Two trench-shaped grenade sumps

- (1) Place one at each end of the position.
- (2) Make the trenches as wide as an entrenching tool blade, as deep as the entrenching tool, and as long as the position is wide.

## Performance Steps

- j. Slope the floor toward the sumps (figure 071-326-5703-6).

**Note:** The slope should be steep enough so that a grenade thrown into the position will easily and quickly roll into one of the sumps.

3. Finish clearing the field of fire.
  - a. Clear only what is absolutely necessary.
  - b. Check the observation and field of fire from inside the position.
4. Save any cut foliage, dirt, or grass clumps to camouflage your position.
5. Construct for the fighting position overhead cover that provides the best possible protection from airbursts while allowing you to fight from underneath it.
  - a. Use logs 10 to 15 centimeters (4 to 6 inches) thick for the supports, base, and top.
  - b. Construct front and rear supports that are the same height as the terrain.
  - c. Cover logs with at least 45 centimeters (18 inches) of dirt.
6. Construct flank overhead cover when frontal overhead cover significantly increases the silhouette of the position, making it vulnerable to detection (figure 071-326-5703-7).

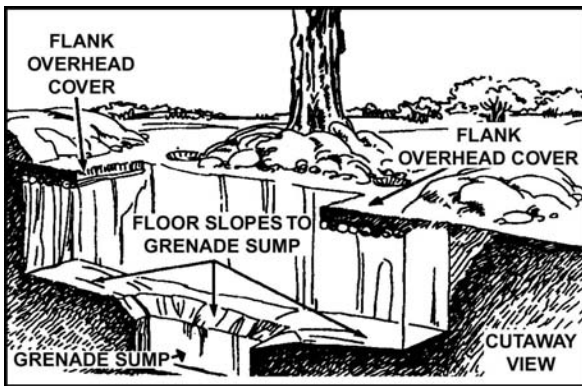

Figure 071-326-5703-7. Flank overhead cover

7. Camouflage your position using available materials, such as grass clumps, foliage, and removed dirt, to make your position blend into surroundings.
8. Check the camouflage by walking out and looking at it from 35 meters away. If you can spot it easily, it needs more work.

**Evaluation Preparation:** *Setup:* Select an area of terrain with varying features such as fences, hedgerows, rocks, trees, and ravines.

*Brief Soldier:* Tell the Soldier the approximate location of enemy positions. Order the Soldier to construct a hasty fighting position and an improved fighting position.

Performance Measures	GO	NO GO
1. Prepared a hasty fighting position.	___	___
2. Prepared a one-man fighting position.	___	___
3. Disposed of excess dirt.	___	___
4. Dug two trench-shaped grenade sumps.	___	___
5. Sloped the floor toward the sumps.	___	___
6. Finished clearing the field of fire.	___	___
7. Constructed the fighting position overhead cover that gave the best possible protection from airbursts while allowing you to fight underneath of it.	___	___
8. Constructed flank overhead cover when frontal overhead cover would have significantly increased the silhouette of the position, making it vulnerable to detection.	___	___
9. Camouflaged your position using available materials so that it was not visible from 35 meters to the front.	___	___

**Evaluation Guidance:** Refer to chapter 1, paragraph 1-9e, (1) and (2).

**References**

**Required:** FM 7-8

**Related:**

## 071-331-0801

### Challenge Persons Entering Your Area

**Conditions:** Given the current challenge and password, a defensive position with a designated sector of fire, an individual weapon, load-carrying equipment (LCE), and the possibility that enemy and friendly personnel could enter the sector.

**Standards:** Detect and halt all personnel in your sector. Challenge each to use the correct challenge. Allow personnel who give the correct password to pass. Detain or capture personnel who give the incorrect password. Prevent the enemy from overhearing the password.

#### Performance Steps

1. One person desires to pass.
  - a. Upon seeing or hearing someone approach your position, command the person to halt before he/she gets close enough to pose a threat. Use a clear voice, just loud enough to be heard.
  - b. When you see a strange Soldier, halt and cover him/her without exposing your position and ask, "Who is there?" Repeat this in a clear, barely audible voice, not loud enough for a nearby enemy to hear.

## Performance Steps

- c. When the stranger identifies himself or herself, such as "Private Willard, messenger," order him or her to advance to be recognized.
  - d. Maintain your concealed position, and keep the stranger covered with your weapon. When the stranger gets within 2 or 3 meters of you, again order him or her to halt.
  - e. Issue the challenge in a soft voice. Wait for the stranger to reply with the correct password. Upon hearing the correct password, give permission to pass if you have no doubt. If a doubt still exists, demand further identification or ask a question only a friendly person would be able to answer.
2. A group desires to pass.
- a. The procedure and precautions for a group are almost the same as for one person. When you see or hear a group approach, order it to halt before its members can move close enough to pose a threat to you.
  - b. The leader of the group should identify the group, such as "Friendly patrol." Since you do not want the whole group to advance at once, order, "Advance one person to be recognized."
  - c. After the leader comes forward to be recognized, issue the challenge.
  - d. Once you receive the correct password, have the rest of the patrol advance one by one and ensure that the leader identifies each person.
  - e. Disarm and detain any person(s) who fails to identify himself/herself to the leader's satisfaction. Then, notify your immediate supervisor.

**Evaluation Preparation:** *Setup:* Simulate a situation in which Soldiers can use the challenge and password. Issue the challenge and password to those who will play the role of friendly troops. Issue both the correct and incorrect passwords to those who will play the roles of unidentified troops. Ask the person playing the intruder(s) to vary his/her responses to challenges.

*Brief Soldier:* Tell the Soldier to challenge all those who approach the defensive position.

Performance Measures	GO	NO GO
1. Said "Halt" before the person was close enough to pose a threat.	___	___
<i>Note:</i> The person has halted.		
2. Said "Who is there?" and kept the unknown individual covered.	___	___
<i>Note:</i> The stranger identified himself/herself.		
3. Said, "Advance to be recognized."	___	___



Performance Measures	GO	NO GO
4. Maintained a concealed position, kept the individual covered, and said, "Halt," when he/she was 2 or 3 meters away.	_____	_____
5. Issued the challenge.	_____	_____
a. Permitted the person to pass if the password was correct.	_____	_____
b. Disarmed (if applicable) and detained the person, if the password was not correct.	_____	_____
c. If still in doubt, asked for further identification or asked a question only a friendly person would be able to answer.	_____	_____

**Evaluation Guidance:** Refer to chapter 1, paragraph 1-9e, (1) and (2).

**References**

**Required:**

**Related:** FM 21-75 and FM 22-6

## 071-331-0815

### Practice Noise, Light, and Litter Discipline

**Conditions:** As a member of an element conducting a tactical mission.

**Standards:** Ensure that—

1. Noise is kept at a minimum.
2. No light is visible to the enemy.
3. The area is free of litter and other evidence of the unit's presence.

#### Performance Steps

1. Comply with noise discipline.
  - a. Avoid all unnecessary vehicular and foot movement.
  - b. Secure (with tape or other materials) metal parts, such as weapon slings, canteen cups, and identification tags, to prevent them from making noise during movement.
  - c. Be careful to avoid restricting the movement of the parts of the weapon that must move in order for you to operate it.
  - d. Talk only when necessary to conduct or explain operations.
  - e. Use radios only when necessary; keep the volume low so only you can hear the radio.
2. Comply with light discipline.
  - a. Do not smoke except when concealed from enemy view.

## Performance Steps

**Note:** Smoking at night should be restricted, as the enemy can see and smell the smoke.

- b.** Conceal flashlights and other light sources so that the light is filtered, for example, under a poncho.
    - c.** Cover anything that reflects light, for example, metal surfaces, vehicles, glass.
    - d.** Use all available natural concealment.
    - e.** Camouflage all vehicles and equipment.
  - 3.** Comply with litter discipline.
    - a.** Take all litter, such as empty food containers, empty ammunition cans or boxes, and old camouflage, to established collection points when occupying a position.
    - b.** Carry all litter with you until you can dispose of it without leaving any trace when moving.

**Evaluation Preparation:** *Setup:* Schedule this exercise in conjunction with field maneuvers or field exercises, or use defensive positions.

Performance Measures	GO	NO GO
1. Complied with noise discipline requirements.	___	___
2. Complied with light discipline requirements.	___	___
3. Complied with litter discipline requirements.	___	___

**Evaluation Guidance:** Refer to chapter 1, paragraph 1-9e, (1) and (2).

### References

**Required:** FM 7-8

**Related:**

## 071-331-0852

### Clear a Field of Fire

**Conditions:** Given a partly completed fighting position with an assigned sector of fire containing thick underbrush and small to medium trees, an entrenching tool and an axe, a specified depth or sector of fire to be cleared, and a designated amount of time in which to clear the field of fire.

**Standards:** Clear the sector of fire out to the specified distance so that—

1. From your position, you can see anyone who moves through your sector of fire.
2. No one moving into your sector of fire would recognize it as a cleared area.

## Performance Steps

1. Estimate how much clearing can be done in the time available.

*Note:* This estimate often determines the nature and extent of the clearing to be undertaken, since a field of fire improperly cleared might afford the enemy better concealment and cover than if you left the area in its natural state.

2. Leave a thin natural screen of vegetation to hide the defensive position so as not to disclose your position by excessive or careless clearing.

3. Clear a narrow lane of fire:

- a. Start near your position, working forward.
- b. Work in an irregular pattern so as not to reveal the weapon's position.
  - (1) Prune trees forward of your position.
    - (a) Remove lower branches of large trees in wooded areas.
    - (b) Cover cuts on trees and bushes with mud, dirt, or snow.
  - (2) Remove or thin dense brush.

*Note:* Brush is never a suitable obstacle, and it obstructs your field of fire.

- (3) Cut weeds only where they obstruct your view.

4. Drag away cut brush, limbs, and weeds to points where they will not be detected by the enemy or furnish the enemy with concealment.

5. Ensure that no trails are made in your sector of fire as lanes are cleared.

**Evaluation Preparation:** *Setup:* Select a suitable section of terrain for the exercise.

*Brief Soldier:* Tell the Soldier how large an area to clear and the amount of time available to clear it.

Performance Measures	GO	NO GO
1. Estimated how much clearing could be done in the time available.	___	___
2. Left a thin natural screen of vegetation to hide the defensive position.	___	___
3. Cleared a narrow lane of fire that began near your position and formed an irregular pattern that did not reveal the weapon's position.	___	___
4. Drag away cut brush, limbs, and weeds to points where they would not be detected by the enemy or furnish the enemy with concealment.	___	___
5. Ensured that no trails were made in the sector of fire as you cleared lanes.	___	___

**Evaluation Guidance:** Refer to chapter 1, paragraph 1-9e, (1) and (2).

## References

### Required:

Related: FM 7-7 and FM 7-8

---

# 071-331-1004

## Perform Duty as a Guard

**Conditions:** Given an assigned guard post, post-specific equipment, and special orders.

**Standards:** Perform duty according to general orders, special orders, and local standing operating procedures (SOPs).

---

### Performance Steps

1. Receive order changes, if any.
2. Walk posts or assume the prescribed position, carrying the weapon in the prescribed manner.
3. Salute officers when performing guard duty on posts that do not require a challenge.
4. Challenge personnel as specified by special orders. The challenge position is port arms or raised pistol.

a. Challenge one person by assuming the challenge position approximately 30 steps from individual and stating "Halt." Once the individual has halted, the guard calls "Who is there?"

*Note:* The guard may change position to best determine if the individual should be passed, denied access or apprehended and turned over to the commander of the relief. Take the appropriate action based on identification of the person.

b. Challenge a group in the same manner. If persons are in a vehicle, allow only one person to approach for identification.

c. Challenge multiple groups or individuals. The guard challenges multiple groups and individuals in the same manner. The guard advances personnel to be recognized in the same manner; only one at a time and in order of seniority.

*Note:* During a duty tour, a guard is required to execute orders ONLY from the commanding officer, the field officer of the day, the officer of the day, and officers of the guard. A guard surrenders his/her weapon only to, and only upon orders from whom he/she lawfully receives orders from while on post.

5. Pass on changes to orders to his/her relief.

---

**Evaluation Preparation:** *Setup:* At the test site, provide the Soldier with a guard post, equipment needed to operate that post, and special orders. Provide a group to approach the post.

*Brief Soldier:* Tell the Soldier to read the special orders and assume the sentry duties of the post.

Performance Measures	GO	NO GO
1. Received order changes.	___	___
2. Saluted officer when required. (Post did not require challenging).	___	___
3. Challenged individual.	___	___
4. Challenged group.	___	___
5. Passed the order changes to the relief.	___	___

**Evaluation Guidance:** Refer to chapter 1, paragraph 1-9e, (1) and (2).

**References**

**Required:**

**Related:** FM 22-6

## 071-440-0028

### Engage Targets During an Urban Operation

**Conditions:** Given an individual weapon with ammunition and load-bearing equipment in urban terrain, with the enemy location uncertain, and specific rules of engagement (ROE).

**Standards:** Engage targets to suppress or kill the enemy.

#### Performance Steps

1. Move with your assigned individual weapon using one of the two weapon-carrying techniques for an urban environment. When moving, hold your weapon with the muzzle pointed in the direction of travel. Place the butt of the rifle or carbine into the pocket of your shoulder. Point the muzzle slightly downward to allow you an unobstructed view. Use your firing hand only to fire; use your nonfiring hand to open things, to signal, or to throw grenades.
2. Shoot while moving toward the point of domination. Take shots as close to the target as 1 or 2 inches. You will shoot while the clearing team members are moving. Therefore, use a "careful hurry." Do not rush in with disregard for any obstructions that might litter the floors, just to get to the points of domination. The most important point is to lead with your weapon, not with your body. Move no faster than you can accurately engage targets.
3. Avoid "flagging," or leading, with the weapon when working around windows, doors, corners, or areas where you must negotiate obstacles. Flagging the weapon warns anyone looking in that direction, making it easier for an enemy to grab your weapon or to react to the clearing team. Control your weapon at all times.

## Performance Steps

4. When moving in buildings or rooms, you can use either of two weapon-carrying techniques with the M16A2 or M4. The purpose of using these techniques is to prevent injuries to friendly personnel. These techniques are "low ready" and "high ready."

a. Low ready position. Place the butt of the weapon firmly in the pocket of your shoulder, with the barrel pointed downward at a 45-degree angle. This is the safest ready position. Use it while clearing rooms, except when you are actually entering and clearing.

b. High ready position. Hold the butt of the weapon under your armpit, with the barrel pointed slightly upward. Keep the front sight assembly under your line of sight, but within your peripheral vision. To engage a target, push the weapon out as if to bayonet the target. When the weapon leaves your armpit, slide it up into your firing shoulder. This technique is best suited for the lineup outside the door.

c. Stance. Keep your feet about shoulder-width apart. Point your toes straight to the front, that is, in your direction of movement. Stagger your firing side foot slightly to the rear of your nonfiring side foot. Bend your knees slightly and lean your upper body slightly forward. Avoid rolling or slouching your shoulders. Keep your firing side elbow in against your body. Modify as needed to ensure that you maintain a comfortable boxer stance. When engaging targets, hold the weapon with the butt in the pocket of your shoulder.

5. Detect targets in your assigned sector and discriminate between enemy and friendly. If multiple targets are present, determine the most immediate threat first, and engage it. Then, switch to the next most immediate threat, and so on, until you complete the engagement. Be prepared to reengage targets that remain standing or that are resisting.

**Note:** In close-quarters combat encounters, engagements are within 10 meters and happen very fast; that is, the target might only be exposed for a few seconds. Most close-quarters engagements are won by hitting first and putting the enemy down. Knocking down a man as soon as possible is more important than killing him. To win a close-quarters engagement, you must make quick, accurate shots by mere reflex. To do this, you must properly apply reflexive firing techniques. This method of shooting is the only way for clearing team members to succeed consistently with the least casualties.

6. Aim. The following four aiming techniques all have their place in urban operations:

a. Slow aimed fire. This technique is the most accurate. Obtain a steady, properly aligned sight picture, and squeeze off rounds. Use this technique for engagements between 25 and 50 meters, or when accuracy is more important than speed.

## Performance Steps

**b.** Aimed quick kill. Place the front sight post flush on top of the rear aperture sight. Use this for very quick shots from 0 to 11 meters. Again, windage is important, but elevation is less critical relative to the target.

**c.** Instinctive fire. This is the least accurate technique. Focus on the target and point the weapon in the general direction using muscle memory reflex to fire. One technique is to adjust the placement of your nonfiring hand for accuracy. While gripping the handguard, extend your index finger down the barrel, so that, when you point your index finger toward the target, the barrel is automatically on line.

**d.** Shot placement. When clearing a room, incapacitate enemy soldiers immediately. Shots that merely wound or that are mortal but fail to incapacitate the target at once are only slightly better than clean misses.

*Note:* Two fundamentals of successful reflexive firing techniques:

- Always fire until the enemy goes down.
- Keep both eyes open.

**7.** Concentrate on achieving solid, well-placed hits to the target. You can achieve these by aiming and striking a target center of mass.

**8.** The lethal zone of the target is center of mass between the waist and the chest (torso lethal zone 18 inches x 8 inches) or center of mass in the head and neck area (neck/head lethal zone 4 inches x 8 inches).

**9.** You must know the capabilities of your weapon, and you must control your fires during target engagement.

**a.** Controlled Pair. The front sight post moves in a natural arc after the round is fired and the recoil kicks in. Let the barrel go with this arc, and then immediately bring the front sight post back on target. Reacquire the sight picture and take a second shot. Do not fight the recoil. Keep shooting until the enemy goes down.

**b.** Automatic Fire. Automatic fire is an option in a close-quarters combat environment. It is effective for violence of action when you need fire superiority to gain entry. Fire automatic fire in controlled bursts only (two to three rounds). Once properly trained, you will be able to fire 6 rounds (two bursts) in the same time that you could fire 2 rounds in a controlled pair. Accuracy is important when engaging targets with automatic fire. The major disadvantages are the amount of ammunition used and the slight reduction in control of fire. Normally, only the first and second Soldiers entering a room should use this technique, due to the possibility of a stray round. However, the M249 gunner must become proficient in this technique, and he/she might be used in any entry position. One technique to ensure accuracy is to concentrate on squeezing, not jerking, the trigger. Jerking the trigger is a common tendency when firing automatically.

## Performance Steps

10. If your weapon malfunctions during any close-quarters combat, immediately take a knee to perform immediate action, unless you are in a doorway or staircase. In such a situation, seek cover, if possible. If needed, stand up to engage targets. Avoid impeding the movement of the other team members. Save precious seconds by continuing to engage from one knee. Whenever other members of the team see a Soldier take a knee stance, they must automatically clear his/her sector of fire. Before rising, warn the clearing team members that you are about to move, and only rise after they acknowledge. This reduces the chance of fratricide among team members. Another technique is to remain in place until after the engagement, when another team member comes and signals you to arise.

**Evaluation Preparation:** *Setup:* At the test site, provide all materials and equipment given in the task conditions statement.

*Brief Soldier:* Tell the Soldier that he/she will be moving as a designated member of an assault element in urban terrain. Enemy strength and location are unknown.

Performance Measures	GO	NO GO
1. Demonstrated two weapon-carrying techniques inside the building.	___	___
2. Engaged enemy targets; did not engage civilians or friendly forces.	___	___
3. Engaged targets using aiming techniques.	___	___
4. Engaged targets using the appropriate trigger-control method.	___	___
5. Demonstrated shot placement in a lethal zone.	___	___
6. Continued to fire until the target went down.	___	___
7. Cleared malfunctions.	___	___

**Evaluation Guidance:** Refer to chapter 1, paragraph 1-9e, (1) and (2).

### References

#### Required:

**Related:** FM 3-21.71 and FM 7-8

## 191-376-4114

### Control Entry to and Exit from a Restricted Area

**Conditions:** You are assigned to control entry to and exit from a restricted area. You are given special orders, identification cards or badges, local standing operating procedures (SOPs), access rosters, communications equipment, locally produced forms, and the current duress code.



**Standards:** Prevent unauthorized personnel, packages, and/or vehicles from entering or leaving the restricted area.

---

**Performance Steps**

---

1. Identify personnel before allowing them to enter or exit the restricted area.
  - a. Ensure that only one individual is processed in or out at any given time.
  - b. Verify the person's identity by comparing the person's face with the photograph on the identification card.
  - c. Ensure that the name of the person attempting to enter is on the access roster. The site commander or custodian must authenticate the access roster.
  - d. Obtain authority to enter, if applicable, for personnel whose names are not on the access roster. Call the sergeant of the guards, the security officer, or the vouching officer.
  - e. Ensure that personnel entering the facility know the most direct route to their destination.
2. Use the following card and badge systems:
  - a. Single card or badge system. Permission to enter is shown on the card or badge by letters, numerals, or colors.
  - b. Card or badge exchange system.
    - (1) The individual entering the area presents the badge or card to the guard and the guard exchanges it with the card or badge kept at the entrance.
    - (2) The individual again exchanges the card or badge when leaving the area.

*Note:* Always keep the second card or badge in the area.

  - c. Multiple card or badge system.
    - (1) Exchange the card or badge at the entrance to each security area within the installation.
    - (2) Keep cards and badges at each area only for those personnel who have the appropriate card or badge.
    - (3) Brief the badge holder that the badge must be displayed at all times when in the controlled or restricted area.

*Note:* For comparison purposes, the card and badge data are identical.
3. Obtain an escort for visitors with authority to enter the restricted area according to special orders.
4. Use challenges, passwords, and code words in tactical areas.
5. Use a duress code.
6. Check the authorization for vehicle entry and exit.
  - a. Log all vehicles entering or leaving the area. Include in the log the description of the vehicle, the identity of the driver, the purpose of the visit, and the destination.

## Performance Steps

- b. Arrange an escort for all vehicles entering the area according to special orders.
7. Prohibit entry (into the restricted area) of harmful material—such as matches, cameras, and any other items prohibited by the special orders.
  - a. Be alert for the wrongful appropriation, pilferage, or compromise of materials or recorded information.
  - b. Make periodic spot checks of personnel.
  - c. Search all packages.
  - d. Search vehicles before allowing them to enter or exit.
8. Take the appropriate actions in the event of a security violation.
  - a. Detain the suspect until help arrives.
  - b. Report a discovery of security violations.
  - c. Apprehend the suspect.
  - d. Prepare a detailed, written report.

**Evaluation Preparation:** *Setup:* Create scenarios using the various control techniques and provide the materials and equipment necessary for each. Have other Soldiers role play the part of authorized and unauthorized personnel.

*Brief Soldier:* Tell the Soldier being evaluated the challenge word, password, code word, or duress code to be used.

Performance Measures	GO	NO GO
1. Identified personnel before allowing them to enter or exit the restricted area.	___	___
2. Used the card and badge systems.	___	___
3. Obtained an escort for visitors with authority to enter the restricted area according to special orders.	___	___
4. Used challenges, passwords, and code words in tactical areas.	___	___
5. Used a duress code.	___	___
6. Checked the authorization for vehicle entry and exit.	___	___
7. Prohibited entry (into the restricted area) of harmful materials—such as matches, cameras, and any other items prohibited by the special orders.	___	___
8. Took the appropriate actions in the event of a security violation.	___	___

**Evaluation Guidance:** Refer to chapter 1, paragraph 1-9e, (1) and (2).

## References

### Required:

Related: AR 50-5, FM 3-21.6, and TC 19-138

---

## 191-377-4254

### Search a Detainee

**Conditions:** Given your individual equipment, assigned weapon, a detainee, disposable restraints, a guard, an interpreter (if available), Department of the Army (DA) Form 4002 (*Evidence/Property Tag*) and DA Form 4137 (*Evidence/Property Custody Document*), Department of Defense (DD) Form 2745 (*Enemy Prisoner of War [EPW] Capture Tag*), and materials to mark and bundle evidence and property.

**Standards:** Search and restrain the detainee sequentially according to the performance steps; locate and confiscate all weapons, contraband, and items of intelligence value; and prepare DD Form 2745 and DA Form 4137 without error.

#### Performance Steps

##### 1. Position the detainee.

**CAUTION**

Stay out of the reach of the detainee.

- a. Direct the detainee to stand and face you.

**Note:** If an interpreter is not available, you may have to demonstrate the desired movement to the detainee to overcome the language barrier.

- b. Direct him/her to raise his/her arms above the head, lock elbows, and spread hi/hers fingers with the palms facing you.
- c. Visually check the detainee's hands for weapons or contraband.
- d. Order the detainee to turn around and drop to his/her knees.
- e. Search the back of the detainee's hands for weapons or contraband.
- f. Direct the detainee to lie on his/her stomach with arms straight out to the sides with the palms up, and forehead on the ground.
- g. Tell the detainee to spread his/her legs as far apart as possible with the feet outward and the heels in contact with the ground.
- h. Ensure that the guard remains in front of and at an oblique angle to the detainee (opposite the side being searched).

##### 2. Restrain the detainee.

**Note:** The situation may also dictate using a blindfold, ear plugs, or a muffle (an item to prevent speech or outcry without causing injury, such as cloth) as deemed appropriate or directed by your supervisor.

- a. Approach the front of the detainee at about a 45-degree angle from the side opposite the guard and focus the search on the side of the detainee closest to you.

## Performance Steps

b. Squat and put your knee that is closest to the detainee on the detainee's lower back.

*Note:* This is done to ensure control, not to inflict pain or discomfort.

c. Direct the detainee to put the arm that is closest to the searcher behind the detainee's back with the palm facing up.

d. Maintain positive control of that arm.

e. Grasp the detainee's other hand in a handshake hold, pull it across the top of the hand already under control, apply disposable restraints, and tighten them.

### CAUTION

The disposable restraints should be tight enough to secure the detainee's hands but loose enough to allow one finger between the disposable restraints and the detainee's wrist. Ensure that the disposable restraints do not restrict the detainee's circulation.

3. Search the detainee.

*Note:* The body search is the prone frisk search. It is used to quickly detect contraband or weapons that could be used to cause injury or death.

a. Use the bending and crushing technique, remove items as items are discovered, and set them aside.

*Note:* Conduct same-gender searches when possible. If mixed-gender searches are necessary for speed and security, conduct them in a respectful manner and in the presence of an additional witness to address false claims of misconduct. Further, consider your location at the time of the search and try to use any cover or protective barrier when possible.

(1) Bend the seams to determine if razor blades or similar devices are hidden.

(2) Grasp loose clothing, pull it away from the skin, and squeeze it to detect objects hidden under or within clothing.

(3) Cover each area by repeating the crushing technique until you are sure there are no hidden objects.

b. If you find a weapon at any point during the search, loudly announce the weapon found so that the guard and interpreter can clearly hear (for example, gun, knife, or razor).

(1) Alert the guard.

(2) Remain in firm contact with the detainee as you remove the weapon from its hiding place.

(3) Stand up with the weapon, being careful not to walk between the guard and the detainee, and place the weapon a safe distance away within view of the guard.

(4) Return to the detainee and continue searching.

c. Hold the disposable restraints between the detainee's hands and lift his/her arms slightly. Search the area in the small of the back.

## Performance Steps

- d. Release the disposable restraints and stand.
- e. Move to the area of the detainee's waist and face the detainee's head, squat (but do not rest your knee on the ground or on the detainee), and pivot (if required) to conduct the rest of the search.
  - f. Remove the detainee's headgear (if not already removed).
    - (1) Bend the seams, before crushing, to determine if razor blades or similar devices are hidden.
    - (2) Place the headgear on the floor or ground.
  - g. Search the detainee's head and hair.
  - h. Search the detainee from fingers to shoulders.
    - (1) Search the collar and neck area (pull dog tags or necklace to the detainee's back).
    - (2) Remove anything that could be used as a weapon.
  - i. Search the detainee's back from shoulder to waist on the side closest to the searcher.
    - (1) Grasp the inside of the detainee's closest elbow.
    - (2) Pull the detainee upward onto his/her side just high enough to search the front (shoulder to waist) without placing the detainee completely on his/her side.
- Note:* When searching a female detainee at chest level, the searcher searches down the middle of the bra; around the breast, below the bra, and along the connecting point on the bra and the back, if the clasp is not there, for contraband.
- j. Switch hands while controlling the detainee's elbow without changing position.
- k. Search the detainee from waist to knee, including the crotch.
  - Note:* Do not be timid while searching the detainee's groin area. Experience has proven that this is a prime location for hiding weapons and contraband. Check it thoroughly.
- l. Return the detainee to the face down position, release the elbow and remind the detainee to keep his/her feet spread and his/her heels on the ground.
- m. Direct the detainee to raise his/her leg by bending his/her knee.
- n. Grasp the detainee's foot and search from the knee up to the foot. Check the footwear edges and soles.
  - (1) Check the top of the footwear by inserting a finger in the top edge and feeling for weapons.
  - (2) Check the footwear edges and soles.
- o. Direct the detainee to put the foot back down.
- p. Stand and move to the detainee's unsearched side. Move around the detainee's head, but do not walk between the detainee and the guard.

## Performance Steps

q. Ensure that the guard rotates to the other side of the detainee (the side opposite the side to be searched) while maintaining a 45-degree angle from the detainee's head.

r. Squat beside the detainee with your body facing the same direction as the detainee's head and search the other side in the same manner as the first.

### CAUTION

When preparing to turn detainees over, they may attempt to spit or bite at the searcher. Anticipate this and move as appropriate to avoid such an act.

**Note:** The search is now complete and you have confiscated all material found on the detainee.

s. Assist the detainee to stand.

(1) Turn the detainee onto the side facing away from you.

(2) Direct the detainee to bring his/her knees to his/her chest.

(3) Grasp the detainee's arms at the shoulder area and assist him/her to his/her knees.

(4) Pull back on the detainee's arms to help him/her rise to his/her feet.

(5) Ensure that the guard remains focused on the detainee and gathers information as to the detainee's demeanor.

**Note:** The DD Form 2745 and DA Form 4137 should be completed at the point of capture. However, when you are in imminent danger, these two steps can be completed once you and the detainee are in a safe location.

4. Complete a DD Form 2745.

**Note:** The DD Form 2745 is a perforated three-part form that is individually serial-numbered. If you run out of DD Forms 2745, use a field-expedient method to tag.

a. Ensure that the following minimum information is recorded:

(1) The date and time of capture.

(2) His name (if known).

**Note:** Use the DD Form 2745 number as the detainee's name to account for those that are unable or unwilling to provide this information (for example, those who are sick or injured and/or those who do not speak English if an interpreter is not available).

(3) The location of the capture (grid coordinates).

(4) The capturing unit.

(5) The circumstances of the capture, (for example how the detainee was captured, did the detainee resist, and did the detainee surrender). Record the following minimum information:

**Note:** Due to the limited space on the DD Form 2745, you may need or be required to document the circumstances of the capture on a separate sheet of paper or another form, such as the DA Form 2823.

**Note:** Circumstances of capture are essential in determining individual detainee status, making subsequent decisions to release or detain, and collecting and

## Performance Steps

documenting items of intelligence and evidentiary value for custody transfer decisions or future judicial proceedings.

(a) Various groups, locations, and activities from which the individual detained was operating.

(b) The physical condition of the detainee.

(c) The weapons the detainee had, if applicable.

b. Tag the detainee and his/her equipment. (If you are using a field-expedient method, ensure that you make three copies to represent parts A, B, and C of the form.) Distribute the DA Form 2745 tag as follows:

(1) Ensure that part A is attached to the detainee.

(2) Retain part B for yourself and/or the unit.

(3) Ensure that part C is attached to confiscated property (an individual item or attached to a bag or bundle).

5. Document property/evidence.

a. Mark all confiscated items with the detainee's DD Form 2745 number using one of the following methods (if time permits and materials are available):

(1) Place the DD Form 2745 number in the "MPR/CIR Sequence Number" field of DA Form 4002 and annotate the item number from the DA Form 4137 and a short description in the remarks block.

*Note:* This is the preferred method for large items because it does not damage them.

(2) Place the evidence on party in a reseal able bag and mark the outside of the bag with a permanent marker.

*Note:* This is the preferred method for small items.

(3) Write the number directly on the property with a permanent marker.

(4) Etch the number using a sharp object.

*Note:* Carefully consider how and where to place identification marks on items. Unnecessary damage or destruction of items of personal property or valuable items that may ultimately be returned to the detainee or suspect is unwarranted. To avoid defacing or damaging items, identification markings should be as inconspicuous as possible. Otherwise, place the item in a container that can be sealed and marked.

b. Prepare DA Form 4137.

(1) Annotate the DD Form 2745 number in the "MPR/CID sequence number" block.

(2) Insert the name of your unit in the "Receiving Activity" block.

(3) Place an accurate description of the location your organization is currently based in the "location" block (for example, the installation, state, and zip code or the deployed base camp and/or operating base).

(4) Enter the name, grade, and title (if known) of the person who owned or possessed the confiscated items in the block labeled, "Name, Grade, and Title of Person from Whom Received."

## Performance Steps

(5) Check the "Owner" box if the person or detainee owns the property that you confiscated during the search with the detainee's first name, middle initial, last name, rank, and title.

(6) Check the "Other" box if ownership is unknown. For example, a weapon is discovered by another individual or turned in by another unit at the point of capture.

(7) Enter not applicable (NA) if the property does not come from a specific person (for example, the item is found at a certain location or is collected during a search).

c. Enter the address of the person from whom you received the items in the "Address" block, if known. If it did not come from a person (if it came from a crime scene or point of capture), enter NA.

d. Fill in the "location from where obtained" block. If evidence and/or property was obtained from—

(1) A person, enter "person of" and then enter their grade and last name and the location where the evidence and/or property was collected. Describe where the item was found on the person (for example, removed from left front pants pocket).

(2) A location, annotate the exact location when the property was found in the area that the detainee was captured; for example, a description might read, "two-story house next to Exxon station on MSR Tampa IVO Baghdad."

e. Enter the reason for confiscation in the "reason obtained" block (for example, confiscated during search of the detainee).

f. Record the date-time group of confiscation or item discovery (1400 hrs/15 Sep 06). Indicate the time span when they were collected (1400 hrs-1500 hrs/15 Sep 06) if several items were confiscated. Note the first time when the first item was taken and note the last time when the last item was confiscated.

g. Enter the item numbers. List items consecutively.

h. List the quantity of each item in the "quantity" column. (Like items may be listed as a group; for example, 20 pills found in a container may be entered as one entry.)

i. Describe each item in the "Description of Articles" block. Describe each item by what can be observed. Use plain bond paper to record the continuation if necessary.

(1) Specify where and how you marked the items for identification (for example, "Marked for ID, 0090829 on barrel").

(2) List the color, size, and shape.

**Note:** Never list or estimate the value of articles or describe the type of metal or stone in items. For example, describe an item that looks like gold as gold-colored metal.

(3) List serial numbers or identifying marks if available.

(4) Place continuous slashes (///) from the left border of the block to the right border of the block to indicate the end of the list.



## Performance Steps

j. Complete the "Chain of Custody" portion of the form to transfer items from the owner or individual from which the item is obtained to the person receiving custody of the items.

(1) Write "1 through 3" in the "Item Number" column if three items are listed in the "Description of Articles" block. The "Chain of Custody" portion of the form is also used to transfer items from one person to another. If only certain items are released, list only those items (for example, "Item 1 and 3")

(2) Enter the date of the custody transfer in the "Date" block.

(3) Fill in the "released by" column as follows:

(a) Enter the full name in the "Name, Grade, or Title" block if the property is confiscated from an individual. Have the person sign in the "Signature" block. Enter the words "Refused to Sign" or "Unable to Sign" in the Signature block if the person refuses or is unable to sign. There is no legal requirement for the form to be witnessed if the individual refuses to sign.

(b) Enter "NA" in the signature block if the property does not come from a specific person (for example, if it is obtained from the capture scene).

(4) Fill in the "Received By" column (for example, enter the name, grade, or title of the person taking custody).

(5) Enter the reason for the custody transfer in the "Purpose of change of custody" column (for example, "Confiscated from detainee," "Detainee transferred to holding area," or "Detainee transferred to local authorities.").

k. Bundle all property (if necessary) and place it in a secure location away from the search area when the search is completed and you have confiscated all the material found on the detainee (allow the detainees to keep their helmet, clothing and any chemical, biological, radiological, and nuclear (CBRN) protective equipment once they have been searched thoroughly).

**Note:** Any material or method may be used to bundle property, as long as it is secure, will protect the property, and can be marked in such a way that it can be tracked with the detainees DD Form 2745 number.

**Evaluation Preparation:** *Setup:* Provide the Soldier with role players as a guard and detainee. Provide the detainee role player with props (a knife, handgun, and/or intelligence papers) to hide on his/her person. The guard role player is not absolutely required to evaluate this task but is recommended to add realism.

*Brief Soldier:* Tell the Soldier he/she is to search the detainee according to the performance steps unless otherwise directed by the evaluator. Instruct him/her as to whether you want him to fill out the appropriate forms on any items confiscated or to explain to you how h/shee would complete them. Tell the guard that his/her role is to provide security and not to assist the searcher in the performance of the task. Tell the detainee to follow the instructions of the Soldier and not to resist.

Performance Measures	GO	NO GO
1. Positioned the detainee.	___	___
2. Restrained the detainee.	___	___

Performance Measures	GO	NO GO
3. Searched the detainee.	_____	_____
4. Completed a DD Form 2745.	_____	_____
5. Documented property/evidence.	_____	_____

**Evaluation Guidance:** Refer to chapter 1, paragraph 1-9e, (1) and (2).

**References**

**Required:** DA Form 4002, DA Form 4137, and DD Form 2745

**Related:**

**191-377-4256**  
**Guard Detainees**

**Conditions:** Given your individual equipment, assigned weapon, an interpreter (when available), the rules of engagement (ROE) or rules for the use of force (RUF), the unit standard operating procedures (SOPs), cloth, and orders to guard already segregated detainees.

**Standards:** Guard the detainees by maintaining accountability and control, ensuring that the detainees remain silent and segregated. Protect detainees from abuse and harm. Follow the ROE/RUF during escape attempts. Correct and report inappropriate treatment and detainee noncompliance to your supervisor.

**Performance Steps**

*Note:* Always maintain positive control and accountability of the detainees.

1. Ensure that your weapons are functional, loaded, and prepared for use, if needed.
2. Position yourself and stay alert.

*Note:* If a detainee has not already been searched and restrained, notify your supervisor.

- a. Remain close enough to maintain positive control, but far enough away to allow defensive reaction time.
- b. Face the detainees, observe everything in their line of sight, and report all incidents to your supervisor.
- c. Ensure that you understand mutually-supported sectors of fire, communications, and battle drills when positioned with others. If you do not, ask your supervisor for clarification.
- d. Observe and report detainee behavior. For example—
  - (1) The detainee speaks fluent English during a medical exam, but feigns no knowledge of English whatsoever during interrogation.
  - (2) The detainee demonstrates leadership by providing instructions to other detainees.

*Note:* This passive intelligence collection is critical during law enforcement, medical, and intelligence processing.

## Performance Steps

3. Ensure that detainees remain silent.
  - a. Do not speak to detainees unless providing orders and/or instructions. Use an interpreter if available. Answer necessary questions, but do not answer personal questions or questions that may compromise or hinder the mission.
  - b. Attempt to stop unauthorized communication with other detainees using language (using an interpreter) and/or signals if a detainee attempts it.
  - c. Report the individuals to your supervisor if they continue and segregate or muffle them (with an item to prevent speech or outcry without causing injury, such as cloth) as appropriate according to the unit SOPs and your supervisor's instructions.
    - (1) Muffle the detainees using a soft, clean cloth stretched across the mouth and around the back of the head.
    - (2) Do not place items in their mouths, hood them, or use tape or other adhesives.
    - (3) Do not harm the detainees or affect their ability to breathe.
    - (4) Check the detainees periodically to ensure that they are not harmed.
    - (5) Muffle the detainees only for as long as needed.
4. Ensure that detainees remain segregated. If a detainee attempts to move out of a designated area or advances on a guard—
  - a. Attempt to use language (an interpreter) or hand signals to stop the behavior.
  - b. React according to published ROE/RUF and notify your supervisor if the detainee continues.
5. Safeguard the detainees.
  - a. Correct, report, and document incidents of inhumane treatment, abuse, or inappropriate conditions.

**Note:** Acts and or omissions that constitute inhumane treatment are violations of the law of armed conflict, and as such must be corrected immediately. Simply reporting violations is insufficient. If a violation is ongoing, every Soldier has an obligation to stop the violation as well as report it.

- b. Report any allegations or observation of abuse to your supervisor.
  - c. Protect detainees from combat hazards and conflict with each other. Protect detainees from the civilian populace, public curiosity, improper treatment or care, and any emergency situation according to the unit SOPs.
  - d. Protect women and children from any form of sexual abuse or harassment.
-

## Performance Steps

e. Do not videotape or photograph detainees except for administrative purposes (for example, documenting in personnel, intelligence, investigative, or medical files).

6. Respond to escape attempts.

a. React to an escape according to rehearsed battle drills and standard operating procedures (SOPs).

(1) Allow the Soldiers and/or guards closest to the escapee to recover him.

(2) Remain focused on the detainees if you are not involved in the recovery of the escapee.

### CAUTION

The remaining detainees will attempt to exploit an escape, as they will with any disruption.

b. Adhere to local ROE/RUF.

c. Maintain situational awareness.

d. Apply the minimum level of force to regain control of detainees. Do not fire on detainees still contained within the wire.

e. Segregate those who attempt escape to prevent a recurrence and their influence on other detainees.

f. Assess escapes thoroughly to prevent future occurrences.

g. Follow the ROE/RUF (normally the following). Use an interpreter, if available.

(1) Order detainees to halt in their native languages, when possible. Repeat the order twice (for a total of three "Halt" commands) if a detainee does not stop after the first order.

(2) If the detainee stops by the third order—

(a) Allow the Soldiers closest to the escapee to recover the detainee.

(b) Maintain security.

(3) If the detainee does not stop—

(a) Use the minimum force necessary to prevent escape and recapture an escapee. Use of an individual weapon is a last resort.

(b) Allow Soldiers closest to the escapee to recover the escapee and maintain security.

### CAUTION

If a detainee is shot or wounded, ensure that proper medical attention is provided.

**Evaluation Preparation:** *Setup:* Provide the Soldier with three or more personnel to act as detainees and a situation which requires them to be guarded.

*Brief Soldier:* Tell the Soldier the detainees have been searched and that he/she is to guard the detainees and that he/she is to take action based on what the detainees do or on the situation presented. Brief the personnel acting as detainees on what they are to do and to follow the instructions of the Soldier guarding them.

Performance Measures	GO	NO GO
1. Ensured that his/her weapon was functional, loaded, and prepared.	_____	_____
2. Positioned himself/herself and stayed alert.	_____	_____
3. Ensured that detainees remained silent.	_____	_____
4. Ensured that detainees remained segregated.	_____	_____
5. Safeguarded the detainees.	_____	_____
6. Responded to escape attempts according to ROE/RUF.	_____	_____

**Evaluation Guidance:** Refer to chapter 1, paragraph 1-9e, (1) and (2).

**References**

**Required:** FM 3-19.40

**Related:**

## 301-348-1050

### Report Information of Potential Intelligence Value

**Conditions:**

1. The commander tasks you to report information concerning the enemy, terrain, and weather in specific locations.
2. You have observed enemy activity and significant terrain and weather features.
3. You have a means of communication (radio, wire, cable, or messenger).

**Standards:** Transmit information to the receiving authority in size, activity, location, unit, time, and equipment (SALUTE format) and significant terrain and weather conditions via radio, wire, cable, or written message with a messenger within 5 minutes after observation with six out of six SALUTE items correctly identified.

**Note:** Your unit standing operating procedures (SOPs) will specify the receiving authority. Examples of receiving authorities are company commander, team commander, or S2 (Intelligence Officer [U.S. Army]) section.

**Performance Steps**

**WARNING**

Do not wait until you have complete enemy information to transmit. Even small amounts of combat information may provide indicators of enemy intentions.

## Performance Steps

1. Identify information concerning enemy activity and significant terrain and weather features including—

a. Order of battle factors; for example, enemy weapons systems, troop composition, and direction of movement.

*Note:* If you cannot identify a weapon system or vehicle by name, include a description of the equipment.

b. Military aspects of terrain; for example, observation and fire, concealment and cover, obstacles, key terrain and avenues of approach.

c. Weather factors; for example, severe weather, precipitation, trafficability, surface winds and gusts, and ground visibility.

*Note:* Use spot reports to transmit information and intelligence of immediate value. Transmit spot reports as rapidly and securely as possible. The SALUTE format, table 1, is an aid for the observer to report the essential reporting elements. (You may precede each message segment of the spot report with the meaning of the acronym SALUTE.)

2. Draft message summary information in the SALUTE format.

3. Select a means of communication; for example, radio, wire, cable, or messenger.

*Note:* Consider the communications means available to you and the information's potential significance to your mission. Radio is fast and mobile; yet, normally it is the least secure of the three communications means available at tactical units. Wire is more secure but is subject to wiretapping and requires more time, personnel, and equipment to install. Messenger is very secure but requires more delivery time and is limited by weather, terrain, and enemy action.

4. Transmit the message to the receiving authority.

a. If using a messenger, provide the messenger with explicit reporting instructions and a message, preferably written, which is clear, complete, and concise.

b. If using a radio, use proper radio/telephone procedures according to the unit SOP and FM 24-1. Use the radio only as needed. The enemy may intercept your transmission, exploit the message information, or locate your transmitter for targeting or jamming.

c. If you encounter jamming or interference on your radio net, within 10 minutes of the incident, transmit a meaoning, intrusion, jamming, and interference (MIJI) report, preferably via messenger, wire, or cable to your net control station. Your signal operating instructions (SOI) contain the MIJI format.

---

**Evaluation Preparation:** *Setup:* Position two to four personnel (dressed in aggressor uniforms if available) where they are observable with the naked eye (or binoculars if available). Direct the aggressors to perform some type of activity such as setting up camp, cleaning weapons, working on a vehicle or studying maps. Provide the Soldier with a 1:50,000 scale topographic map of the test area. If you

require the Soldier to write the report, provide paper and a pen or pencil. If you require the Soldier to radio the report to someone else, provide two radios and SOI. Accompany the Soldier being tested to a location where the Soldier can observe the aggressors.

*Brief Soldier:* Instruct the Soldier to report the activity observed, weather factors, and any significant military aspects of the terrain. Once the Soldier completes the report, have the Soldier select a means of transmitting the report to the next higher headquarters.

Performance Measures	GO	NO GO
1. Identified—	_____	_____
a. Enemy order of battle factors (including weapon systems, troop composition, and direction of movement).	_____	_____
b. Military aspects of terrain; for example, observation and fields of fire, concealment and cover, obstacles, key terrain, and avenues of approach.	_____	_____
c. Weather factors, such as severe weather, precipitation, surface winds and gusts, and ground visibility.	_____	_____
2. Drafted a message in SALUTE format identifying—	_____	_____
a. Size.	_____	_____
b. Activity.	_____	_____
c. Location.	_____	_____
d. Unit.	_____	_____
e. Time.	_____	_____
f. Equipment.	_____	_____
3. Transmitted the message selecting the best means according to the conditions; for example, radio, wire, cable, or messenger.	_____	_____

**Evaluation Guidance:** Refer to chapter 1, paragraph 1-9e, (1) and (2).

## 301-371-1000

### Report Intelligence Information

**Conditions:** You have observed enemy activity and significant terrain and weather features. You must immediately report the activity to your chain of command via radio, wire, cable, or messenger.

**Standards:** Submit observations in a spot report, using the size, activity, location, unit, time, and equipment observed (SALUTE) format, to your chain of command within 5 minutes of observing enemy activity. Identify in the report the size, activity, location, unit, time, and equipment observed.

## Performance Steps

1. Use the SALUTE format to ensure that essential information is reported. If unable to make a determination, report the activity as unknown.
  - a. S—Size. Report the number of personnel, vehicles, aircraft, or size of an object. Make an estimate if necessary.
  - b. A—Activity. Report detailed account of actions (direction of movement, troops digging in, artillery fire, type of attack, CBRN activity, and so forth).
  - c. L—Location. Report where you saw the activity. Include grid coordinates or reference from a known point including the distance and direction from the known point.
  - d. U—Unit. Report the enemy's unit. If the unit is unknown, report any distinctive features, such as uniforms, patches or colored tabs, headgear, vehicle identification markings, etc.
  - e. T—Time. Report the time and date the activity was observed, not the time you report it. Always report local or Zulu time.
  - f. E—Equipment. Report all equipment associated with the activity, such as weapons, vehicles, tools. If unable to identify the equipment, provide as much detail as you can so that higher headquarters can make an identification.
  - g. Remarks. Include any information not included in the SALUTE format.
2. Provide the spot report to the appropriate authority/chain of command using available communication.

**Evaluation Preparation:** *Setup:* Position two to four personnel (dressed in aggressor uniforms if available) where they are observable with the naked eye (or binoculars if available). Direct the aggressors to perform some type of activity such as setting up camp, cleaning weapons, working on a vehicle, or studying maps. Provide the Soldier with a 1:50,000 scale topographic map of the test area. If you require the Soldier to write the report, provide paper and a pen or pencil. If you require the Soldier to radio the report to someone else, provide two radios and signal operating instructions (SOI).

Performance Measures	GO	NO GO
1. Recorded observations of enemy activity in a spot report which includes—	___	___
a. Size		
b. Activity		
c. Location		
d. Unit		
e. Time		



Performance Measures	GO	NO GO
f. Equipment		
2. Reported all information to the appropriate authority/chain of command within 5 minutes of the observation.	_____	_____

**Evaluation Guidance:** Refer to chapter 1, paragraph 1-9e, (1) and (2).

**References**

**Required:** FM 21-75

**Related:**

## 301-371-1050

### Implement Operations Security Measures (OPSEC)

**Conditions:** You have received a unit OPSEC plan, which includes essential elements of friendly information, indicators, vulnerabilities, OPSEC measures, and AR 530-1.

**Standards:** Implement OPSEC measures based on unit indicators and vulnerabilities; protect the unit's essential elements of friendly information against threat collection efforts and prevent compromise.

Performance Steps
-------------------

1. Define OPSEC.
  - a. OPSEC is a process of analyzing friendly actions pursuant to military operations and other activities to—
    - (1) Identify those friendly actions that can be observed by the threat.
    - (2) Determine indicators which the threat might obtain that could be interpreted or pieced.
    - (3) Select and execute measures that eliminate or reduce these vulnerabilities.
  - b. OPSEC maintains essential secrecy, which is the condition achieved by the denial of critical information to the threat. Essential secrecy depends on the combination of two conditions:
    - (1) Provide traditional security programs that deny the threat classified information.
    - (2) Provide operational security to deny the threat critical information, which is always sensitive and often unclassified.
2. Define indicators.
  - a. Indicators are data derived from open sources or from detectable actions that the threat can piece together or interpret to reach conclusions or official estimates concerning friendly intentions, capabilities, or activities. They are also activities that result from military operations. Indicators help determine friendly courses of action. Identifying and interpreting indicators are critical tasks of the threat operations.

## Performance Steps

**b.** The three types of indicators are profile, deviation, and tip-off:

**(1)** There are two types of profile indicators:

**(a)** Patterns are stereotyped actions which so habitually occur that they can cue an observer to the type of military unit or activity—its identity, capabilities, or intent. In the Army, we tend to do things the same way (standing operating procedures [SOPs]).

**(b)** Signatures result from the presence of a unit or activity on the battlefield. Signatures are detected because different units have different types of equipment, are of different sizes, emit different electronic signals, and have different noises associated with them.

**(2)** Deviation indicators provide contrasts to normal activity, which help the threat gain appreciation about intentions, preparations, time, and place.

**(3)** Tip-off indicators highlight information that otherwise might pass unnoticed. These are most significant when they warn the threat of impending activity.

**3.** Identify threat capabilities.

**a.** The threat consists of multiple and overlapping collection efforts targeted against all sources of Army information. The threat devotes significant resources to monitor U.S. military operations and activities on a daily basis. Technology transfer will continue to remain a major concern in the future.

**b.** The major threat collection capabilities fall into four areas:

**(1)** Human intelligence (HUMINT) includes all information derived through human sources not accessible to other collection assets. HUMINT employs overt, covert, and clandestine operations to achieve worldwide collection objectives.

**(2)** Imagery intelligence (IMINT). The threat can obtain IMINT from land, sea, air, and space platforms (radar, photographic, infrared, and electrooptic imagery). At the tactical level, airborne collection possesses the greatest IMINT threat.

**(3)** Signals intelligence (SIGINT) results from the collection, evaluation, analysis, integration, and interpretation of information derived from intercepted electromagnetic emissions.

**(4)** Measurement and signature intelligence (MASINT) is scientific and technical intelligence obtained by quantitative and qualitative analysis of data derived from technical sensors to identify any distinctive features associated with the source, emitter, or sender and to facilitate subsequent identification or measurement.

**c.** Two additional areas of concern are—

**(1)** Technology transfer, which has led to significant enhancement of military-industrial capabilities at the expense of the United States.

**(2)** Nontraditional threats. Past and present allies are potential intelligence threats. They can engage in intelligence collection activities to gain economic or political advantage, which is not in the best interest of the United States.

## Performance Steps

4. Define OPSEC measures. OPSEC measures are methods and means to gain and maintain essential secrecy about critical information.

a. Action control eliminates indicators. Select what action to undertake and decide whether or not to execute actions or impose restraints on actions. (Specify who, when, where, and how.)

b. Countermeasures attack the threat collection system by using—

- (1) Diversions.
- (2) Camouflage.
- (3) Concealment.
- (4) Jamming.
- (5) Deception.

5. Implement the OPSEC process. OPSEC has five steps which apply to any plan, operation, program, project, or activity. They provide a framework for the systematic process necessary to identify, analyze, and protect information for essential secrecy. The process is continuous. It considers the changing nature of the threat and friendly vulnerabilities throughout the operation. It uses the following steps, but it does not have to follow them in a particular sequence.

a. Identify critical information. Critical information consists of specific facts about friendly intentions, capabilities, and activities vitally needed by the threat for it to plan effectively and to guarantee failure or unacceptable consequences for friendly mission accomplishment.

(1) Determine what needs protection.

(2) Identify key questions that threat officials are likely to ask about friendly intentions, capabilities, and activities, so they can obtain answers critical to their operational effectiveness. To determine sensitive aspects of our operations, the following question is asked: If known by the threat, what information and what actions could compromise friendly operations or identify us?

(3) Identify friendly force profile. The G3 and the G2 are responsible for developing friendly force profiles.

(4) Avoid setting patterns.

b. Conduct an analysis of the threats.

(1) Identify OPSEC vulnerabilities. It is absolutely necessary that you know the THREAT. This information will be important in order to determine vulnerabilities to the threat and it will become even more important when the time comes to implement countermeasures or deception measures.

(2) Examine each part of the operation to find OPSEC indicators. Compare those indicators with the threat collection capabilities. A vulnerability exists when the threat can collect an indicator, correctly analyze the information, make a decision, and take timely action to degrade friendly operations.

c. Conduct an analysis of vulnerabilities.

(1) Identify possible OPSEC measures for each vulnerability.

## Performance Steps

(2) Select at least one OPSEC measure for each vulnerability.

(3) Assess the sufficiency of routine security measures (personnel, physical, cryptographic, document, special access, and automated information systems). This will provide OPSEC measures for some vulnerabilities.

d. Perform risk assessment. The purpose of this step is to select OPSEC measures to implement. This step determines if a risk to an operation's success exists should the threat detect friendly indicators, patterns, or signatures. Only the commander responsible for the mission can make this decision. He/she must balance the risk of operational failure against the cost of OPSEC measures.

(1) Consider the impact of an OPSEC measure on operational efficiency.

(2) Consider the probable risk to mission success (effectiveness) if the unit does not implement an OPSEC measure.

(3) Consider the probable risk to mission success if an OPSEC measure does not work.

(4) Decide which, if any, OPSEC measures to implement and when to do so.

(5) Check the interaction of OPSEC measures. Ensure that a measure to protect a specific piece of critical information does not unwittingly provide an indicator of another.

(6) Coordinate OPSEC measures with the other elements of command and control warfare (C2W).

e. Apply appropriate countermeasures to deny THREAT information of specific friendly intentions, capabilities, and activities.

(1) Implement those measures that require immediate action. This applies to current operations as well as planning and preparation for future ones.

(2) Document or task OPSEC measures by using an OPSEC annex to the operations plan/operations order (OPLAN/OPORD).

(3) Brief OPSEC requirements to planners, participants, and support personnel.

*Note:* OPSEC measures are command-directed actions executed by individuals, who must be aware of their responsibilities.

(4) Monitor OPSEC measures during execution. Monitoring is a continuous process of evaluating intelligence and counterintelligence. It is necessary to monitor countermeasures for effectiveness because unevaluated countermeasures can lead to a false and dangerous sense of security.

(5) Make adjustments to improve the effectiveness of existing measures. This will be necessary to obtain the best protection for military operations.

6. Define OPSEC review, assessment, and survey.

a. OPSEC review is an evaluation of a document to ensure protection of sensitive or critical information.

**Performance Steps**

b. OPSEC assessment is an analysis of an operation, activity, exercise, or support function to determine the overall OPSEC posture and to evaluate the degree of compliance of subordinate organizations with the published OPSEC plan or OPSEC program.

c. OPSEC survey is a method to determine if there is adequate protection of critical information during planning, preparations, execution, and postexecution phases of any operation or activity. It analyzes all associated functions to identify sources of information, what they disclose, and what can be derived from the information.

**Evaluation Preparation:** *Setup:* Provide the Soldier with the materials listed in the task conditions statement.

*Brief Soldier:* Tell the Soldier to maintain OPSEC procedures to protect critical aspects of operations from exploitation by threat intelligence.

<b>Performance Measures</b>	<b>GO</b>	<b>NO GO</b>
1. Defined OPSEC.	___	___
2. Defined indicators.	___	___
3. Identified threat capabilities.	___	___
4. Identified OPSEC measures.	___	___
5. Implemented OPSEC measures.	___	___
<b>a.</b> Identified critical information.		
<b>(1)</b> Determined what protection was needed.		
<b>(2)</b> Identified key questions that the threat was likely to ask about friendly intentions, capabilities, and activities.		
<b>(3)</b> Identified friendly force profile.		
<b>(4)</b> Avoided setting patterns.		
<b>b.</b> Conducted analysis of threats.		
<b>(1)</b> Identified OPSEC vulnerabilities.		
<b>(2)</b> Found OPSEC indicators.		
<b>c.</b> Conducted an analysis of vulnerabilities.		
<b>(1)</b> Identified OPSEC measures for each vulnerability.		
<b>(2)</b> Selected OPSEC measures for each vulnerability.		
<b>(3)</b> Assessed the sufficiency of routine security measures.		
<b>d.</b> Performed risk assessment.		
<b>(1)</b> Considered the impact of an OPSEC measure on operational efficiency.		

Performance Measures	GO	NO GO
(2) Considered the probable risk to mission success if the unit did not implement an OPSEC measure.		
(3) Considered the probable risk to mission success if an OPSEC measure did not work.		
(4) Decided which OPSEC measures to implement.		
(5) Checked the interaction of OPSEC measures.		
(6) Coordinated OPSEC measures with the other elements of C2W.		
e. Applied appropriate countermeasures to deny the threat friendly information.		
(1) Implemented measures that required immediate action.		
(2) Tasked OPSEC measures using the OPSEC annex.		
(3) Briefed OPSEC requirements to planners, participants, and support personnel.		
(4) Monitored OPSEC measures during execution.		
(5) Made adjustments to improve the effectiveness of existing measures.		
6. Defined OPSEC review, assessment, and survey.	_____	_____
a. Defined OPSEC review.		
b. Defined OPSEC assessment.		
c. Defined OPSEC survey.		

**Evaluation Guidance:** Refer to chapter 1, paragraph 1-9e, (1) and (2).

**References**

**Required:** AR 530-1, FM 34-60, and FM 90-2

**Related:**

## Chapter 4

### Warrior Tasks and Battle Drills Trainer's Guide

The Chief of Staff of the Army directed the Task Force Soldier Study (September to November 2003) that was conducted at Fort Benning, Georgia. This study identified warrior tasks and battle drills that focused on current operations and provided more rigor and relevance into initial entry training. This ensured that Soldiers leaving the training base were better prepared for combat. These warrior tasks and battle drills are geared toward the contemporary operating environment (COE) and lessons learned.

TRADOC incorporates these warrior tasks and battle drills into all training. This provides an azimuth for the noncommissioned officers to train Soldiers in both individual and technical skills. They are also incorporated into Army warrior training to better prepare units to execute their mission.

The warrior tasks and battle drills list is dynamic and will change based on the needs of the force. As it changes, TRADOC will change its instructions.

Command Sergeant Major  
Training and Doctrine Command  
Fort Monroe, Virginia 236

Table 4-1. Warrior task crosswalk

Supporting Task Number	Description
<b>1: Qualify with Assigned Weapon</b>	
071-100-0001	Zero an M4 or M4A1 Carbine
071-100-0003	Engage Targets with an M4 or M4A1 Carbine
071-100-0004	Maintain an M4 or M4A1 Carbine
071-100-0005	Perform Function Check on an M4 or M4A1 Carbine
071-311-2004	Zero an M16A1 Rifle.
071-311-2025	Maintain an M16-Series Rifle
071-311-2026	Perform a Function Check on an M16-Series Rifle
071-311-2027	Load an M16-Series Rifle
071-311-2028	Unload an M16-Series Rifle
071-311-2029	Correct Malfunctions of an M16-Series Rifle
071-311-2030	Zero an M16A2 Rifle
<b>2: Correct Malfunctions with Assigned Weapon</b>	
071-100-0008	Correct Malfunctions of an M4 or M4A1 Carbine.
071-311-2007	Engage Targets with an M16-Series Rifle

**Table 4-1. Warrior task crosswalk**

<b>Supporting Task Number</b>	<b>Description</b>
<b>3: Engage Targets with M240B Machine Gun</b>	
071-025-0001	Maintain an M240B Machine Gun
071-025-0002	Perform a Function Check on an M240B Machine Gun
071-025-0003	Load an M240B Machine Gun
071-025-0004	Unload an M240B Machine Gun
071-025-0006	Zero an M240B Machine Gun
071-025-0007	Engage Targets with an M240B Machine Gun
<b>4: Engage Targets with M249 Squad Automatic Weapon</b>	
071-312-4025	Maintain an M249 Machine Gun
071-312-4026	Perform a Function Check on an M249 Machine Gun
071-312-4027	Load an M249 Machine Gun
071-312-4028	Unload an M249 Machine Gun
071-312-4030	Zero an M249 Machine Gun
071-010-0006	Engage Targets with an M249 Machine Gun
<b>5: Engage Targets with Caliber .50 M2 Machine Gun</b>	
071-022-0001	Maintain a Caliber .50 M2 Machine Gun
071-022-0003	Load a Caliber .50 M2 Machine Gun
071-022-0004	Unload a Caliber .50 M2 Machine Gun
071-022-0010	Mount a Caliber .50 M2 Machine Gun on an M3 Tripod
071-022-0011	Dismount a Caliber .50 M2 Machine Gun from an M3 Tripod
071-313-3452	Zero a Caliber .50 M2 Machine Gun.
071-313-3454	Engage Targets with a Caliber .50 M2 Machine Gun
<b>6: Engage Targets with MK19 40-mm Machine Gun</b>	
071-030-0001	Maintain an MK19 Machine Gun
071-030-0003	Zero an MK19 Machine Gun
071-030-0004	Engage Targets with an MK19 Machine Gun
071-030-0005	Load an MK19 Machine Gun
071-030-0006	Unload an MK19 Machine Gun
071-030-0007	Perform a Function Check on an MK19 Machine Gun
071-030-0011	Mount an MK19 Machine Gun on an M3 Tripod
071-030-0012	Dismount an MK19 Machine Gun from an M3 Tripod
<b>7: Correct Malfunctions of a Caliber .50 M2 Machine Gun</b>	
071-022-0005	Correct Malfunctions of a Caliber .50 M2 Machine Gun
<b>8: Correct Malfunctions of a M240B Machine Gun</b>	
071-025-0005	Correct Malfunctions of an M240B Machine Gun



**Table 4-1. Warrior task crosswalk**

<b>Supporting Task Number</b>	<b>Description</b>
<b>9: Correct Malfunctions of a M249 Squad Automatic Weapon</b>	
071-312-4029	Correct Malfunctions of an M249 Machine Gun
<b>10: Correct Malfunctions of a MK19 40-mm Machine Gun</b>	
071-030-0008	Correct Malfunctions of an MK19 Machine Gun
<b>11: Engage Targets with Weapon Using a Night Vision Sight</b>	
071-010-0001	Zero a Night Vision Sight, AN/PVS-4, to an M249 Machine Gun
071-010-0002	Mount a Night Vision Sight, AN/PVS-4, on an M249 Machine Gun
071-010-0003	Dismount a Night Vision Sight, AN/PVS-4, from an M249 Machine Gun
071-010-0007	Engage Targets with an M249 Machine Gun Using a Night Vision Sight, AN/PVS-4
071-025-0013	Mount a Night Vision Sight, AN/PVS-4, on an M240B Machine Gun
071-025-0014	Dismount a Night Vision Sight, AN/PVS-4, from an M240B Machine Gun
071-025-0018	Engage Targets with an M240B Machine Gun Using Night Vision Sight, AN/PVS-4
071-025-0023	Mount an AN/PAQ-4-Series Aiming Light on an M240B Machine Gun
071-100-0009	Mount a Night Vision Sight, AN/PVS-4, on an M4 or M4A1 Carbine
071-100-0010	Dismount a Night Vision Sight, AN/PVS-4, from an M4 or M4A1 Carbine.
071-100-0011	Zero a Night Vision Sight, AN/PVS-4, to an M4 or M4A1 Carbine.
071-100-0012	Engage Targets with an M4 or M4A1 Carbine Using a Night Vision Sight, AN/PVS-4
071-315-2308	Engage Targets with an M16-Series Rifle Using a Night Vision Sight AN/PVS-4
071-315-2351	Zero a Night Vision Sight, AN/PVS-4, to an M203 Grenade Launcher
071-706-0001	Operate Night Vision Device, AN/PVS-4
071-710-0001	Maintain Night Vision Sight, AN/PVS-4
071-022-0008	Mount a Night Vision Sight, AN/TVS-5, on a Caliber .50 M2 Machine Gun
071-022-0009	Dismount a Night Vision Sight, AN/TVS-5, from a Caliber .50 M2 Machine Gun
071-030-0016	Mount a Night Vision Sight, AN/TVS-5, on an MK19 Machine Gun

**Table 4-1. Warrior task crosswalk**

<b>Supporting Task Number</b>	<b>Description</b>
071-030-0017	Dismount a Night Vision Sight, AN/TVS-5, from an MK19 Machine Gun
071-030-0018	Zero a Night Vision Sight, AN/TVS-5, to an MK19 Machine Gun
071-030-0019	Engage Targets with an MK19 Machine Gun Using a Night Vision Sight, AN/TVS-5
071-315-0031	Maintain Night Vision Goggles, AN/PVS-5
071-315-0056	Engage Targets with a Caliber .50 M2 Machine Gun Using a Night Vision Sight, AN/TVS-5
071-315-2317	Zero a Night Vision Sight, AN/TVS-5, to a Caliber .50 M2 Machine Gun
071-010-0008	Mount an AN/PAS-13 Thermal Weapon Sight on an M249 Machine Gun
071-010-0009	Dismount an AN/PAS-13 Thermal Weapon Sight from an M249 Machine Gun
071-010-0010	Zero an AN/PAS-13 Thermal Weapon Sight to an M249 Machine Gun
071-010-0011	Engage Targets with an M249 Machine Gun Using an AN/PAS-13 Thermal Weapon Sight
071-022-0017	Mount an AN/PAS-13 Thermal Weapon Sight on a Caliber .50 M2 Machine Gun
071-022-0018	Dismount an AN/PAS-13 Thermal Weapon Sight from a Caliber .50 Machine Gun
071-022-0019	Zero an AN/PAS-13 Thermal Weapon Sight to a Caliber .50 M2 Machine
071-022-0020	Engage Targets with a Caliber .50 M2 Machine Gun Using an AN/PAS-13 Thermal Weapon Sight
071-025-0019	Mount an AN/PAS-13 Thermal Weapon Sight on an M240B Machine Gun
071-025-0020	Dismount an AN/PAS-13 Thermal Weapon Sight from an M240B Machine Gun
071-025-0022	Engage Targets with an M240B Machine Gun Using an AN/PAS-13 Thermal Weapon Sight
071-100-0013	Mount an AN/PAS-13 Thermal Weapon Sight on an M4 or M4A1 Carbine
071-100-0014	Dismount an AN/PAS-13 Thermal Weapon Sight from an M4 or M4A1
071-100-0015	Zero an AN/PAS-13 Thermal Weapon Sight to an M4 or M4A1 Carbine
071-100-0016	Engage Targets with an M4 or M4A1 Carbine Using an AN/PAS-13 Thermal Weapon Sight

**Table 4-1. Warrior task crosswalk**

<b>Supporting Task Number</b>	<b>Description</b>
<b>12: Engage Targets with Weapon Using an Aiming Light</b>	
071-025-0027	Mount an AN/PEQ-2A-Series Aiming Light on an M240B Machine Gun
071-025-0028	Dismount an AN/PEQ-2A-Series Aiming Light from an M240B Machine Gun
071-025-0029	Zero an AN/PEQ-2A-Series Aiming Light to an M240B Machine Gun
071-025-0030	Engage Targets with an M240B Machine Gun Using an AN/PEQ-2A-Series Aiming Light
071-008-0008	Mount an AN/PAQ-4-Series Aiming Light on an M16-Series Rifle
071-008-0009	Dismount an AN/PAQ-4-Series Aiming Light from an M16-Series Rifle
071-008-0010	Zero an AN/PAQ-4-Series Aiming Light to an M16-Series Rifle
071-008-0011	Engage Targets with an M16-Series Rifle Using an AN/PAQ-4-Series Aiming Light
071-010-0012	Mount an AN/PAQ-4-Series Aiming Light on an M249 Machine Gun
071-010-0013	Dismount an AN/PAQ-4-Series Aiming Light from an M249 Machine Gun
071-010-0014	Zero an AN/PAQ-4-Series Aiming Light to an M249 Machine Gun
071-010-0015	Engage Targets with an M249 Machine Gun Using an AN/PAQ-4-Series Aiming Light
071-022-0021	Mount an AN/PAQ-4-Series Aiming Light on a Caliber .50 M2 Machine Gun
071-022-0022	Dismount an AN/PAQ-4-Series Aiming Light from a Caliber .50 M2 Machine
071-022-0023	Zero an AN/PAQ-4-Series Aiming Light to a Caliber .50 M2 Machine Gun
071-022-0024	Engage Targets with a Caliber .50 M2 Machine Gun Using an AN/PAQ-4-Series Aiming Light
071-025-0024	Dismount an AN/PAQ-4-Series Aiming Light from an M240B Machine Gun
071-025-0025	Zero an AN/PAQ-4-Series Aiming Light to an M240B Machine Gun
071-025-0026	Engage Targets with an M240B Machine Gun Using an AN/PAQ-4-Series Aiming Light
071-032-0012	Mount an AN/PAQ-4-Series Aiming Light on an M203 Grenade Launcher

**Table 4-1. Warrior task crosswalk**

<b>Supporting Task Number</b>	<b>Description</b>
071-032-0013	Dismount an AN/PAQ-4-Series Aiming Light from an M203 Grenade
071-032-0014	Zero an AN/PAQ-4-Series Aiming Light to an M203 Grenade Launcher
071-032-0015	Engage Targets with an M203 Grenade Launcher Using an AN/PAQ-4-Series Aiming Light
071-100-0017	Mount an AN/PAQ-4-Series Aiming Light on an M4 or M4A1 Carbine
071-100-0018	Dismount an AN/PAQ-4-Series Aiming Light from an M4 or M4A1 Carbine
071-100-0019	Engage Targets with an M4 or M4A1 Carbine Using an AN/PAQ-4-Series Aiming Light
071-100-0020	Zero an AN/PAQ-4-Series Aiming Light to an M4 or M4A1 Carbine
<b>13: Employ Mines and Hand Grenades</b>	
071-325-4401	Perform Safety Checks on Hand Grenades
071-325-4407	Employ Hand Grenades
071-325-4425	Employ an M18A1 Claymore Mine
071-325-4426	Recover an M18A1 Claymore Mine
<b>14: Perform Voice Communications SITREP/SPOTREP</b>	
113-571-1022	Perform Voice Communications
301-371-1000	Report Intelligence Information
<b>15: Perform voice communications MEDEVAC</b>	
081-831-1000	Evaluate a Casualty for Life-Threatening Conditions
<b>16: Use Visual Signaling Techniques</b>	
071-326-0608	Use Visual Signaling Techniques
<b>17: Perform Movement Techniques During an Urban Operation</b>	
071-326-0541	Perform Movement Techniques During an Urban Operation
071-326-5610	Conduct Movement Techniques by a Squad
<b>18: Engage Targets During an Urban Operation</b>	
071-440-0028	Engage Targets During an Urban Operation
<b>19: Enter a Building During an Urban Operation</b>	
071-326-0542	Enter a Building During an Urban Operation
<b>20: Determine Location on Ground (Terrain Association, Map, and GPS)</b>	
071-329-1000	Identify Topographic Symbols on a Military Map
071-329-1001	Identify Terrain Features on a Map
071-329-1002	Determine the Grid Coordinates of a Point on a Military Map
071-329-1003	Determine a Magnetic Azimuth Using a Lensatic Compass

**Table 4-1. Warrior task crosswalk**

<b>Supporting Task Number</b>	<b>Description</b>
071-329-1004	Determine the Elevation of a Point on the Ground Using a Map
071-329-1005	Determine a Location on the Ground by Terrain Association
071-329-1008	Measure Distance on a Map
071-329-1009	Convert Azimuths
071-329-1011	Orient a Map Using a Lensatic Compass
071-329-1012	Orient a Map to the Ground by Map-Terrain Association
071-329-1014	Locate an Unknown Point on a Map and on the Ground by Intersection
071-329-1015	Locate an Unknown Point on a Map and on the Ground by Resection
071-329-7017	Navigate Using an AN/PSN-11 Precision Lightweight Global Positioning System
071-329-7018	Prepare the AN/PSN-11 Precision Lightweight Global Positioning System Receiver for Operation
071-329-7019	Enter Waypoints into an AN/PSN-11 Precision Lightweight Global Positioning System
<b>21: Navigate from One Point to Another (Dismounted)</b>	
071-326-0515	Select Movement Route Using a Map
071-329-1006	Navigate from One Point on the Ground to Another Point While Dismounted
071-329-1030	Navigate from One Point on the Ground to Another Point While Mounted
071-510-0001	Determine Azimuths Using a Protractor
071-510-0002	Compute Back Azimuths
<b>22: Move Over, Through, or Around Obstacles (Except Minefields)</b>	
071-326-0503	Move Over, Through, or Around Obstacles (Except Minefields)
<b>23: Move Under Direct Fire</b>	
071-326-0501	Move as a Member of a Fire Team
071-326-0502	Move Under Direct Fire
071-326-0511	React to Flares
<b>24: React to Indirect Fire (Dismounted and Mounted)</b>	
071-326-0510	React to Indirect Fire While Dismounted
071-326-3002	React to Indirect Fire While Mounted
<b>25: React to Direct Fire (Dismounted and Mounted)</b>	
071-410-0002	React to Direct Fire While Mounted
071-326-0502	Move Under Direct Fire

**Table 4-1. Warrior task crosswalk**

<b>Supporting Task Number</b>	<b>Description</b>
<b>26: React to Unexploded Ordnance Hazard</b>	
093-401-5040	React to Unexploded Ordnance Hazards
<b>27: React to Man-to-Man Contact (Combatives)</b>	
071-000-0006	React to Man-to-Man Contact
<b>28: React to Chemical or Biological Attack/Hazard</b>	
031-503-1006	Protect Yourself from CBRN Injury/Contamination when Drinking from Your Canteen While Wearing Your Protective Mask
031-503-1015	Protect Yourself from CBRN Injury/Contamination with Mission-Oriented Protective Posture (MOPP) Gear
031-503-1018	React to Nuclear Hazard/Attack
031-503-1019	React to Chemical or Biological Hazard/Attack
031-503-1023	Protect Yourself from CBRN Injury/Contamination when Changing Mission-Oriented Protective Posture (MOPP) Gear
031-503-1024	Replace Canister on Your M40-Series Protective Mask
031-503-1035	Protect Yourself from Chemical/Biological Contamination Using Your Assigned Protective Mask
031-503-1037	Detect Chemical Agents Using M8 or M9 Detector Paper
<b>29: Decontaminate Yourself and Individual Equipment Using Chemical Decontamination Kits</b>	
031-503-1013	Decontaminate Yourself and Individual Equipment Using Chemical Decontaminating Kits
031-503-1033	Decontaminate Your Skin Using the M291 Skin Decontaminating Kit (SDK)
031-503-1034	Decontaminate Your Individual Equipment Using the M295 Individual
031-507-1022	Decontaminate Equipment Using M13 Decontaminating Apparatus, Portable
<b>30: Maintain Equipment</b>	
031-503-1036	Maintain Your Assigned Protective Mask
071-705-0001	Maintain an M68 Sight
071-100-0004	Maintain an M4 or M4A1 Carbine
071-311-2025	Maintain an M16-Series Rifle
071-710-0001	Maintain Night Vision Sight, AN/PVS-4
071-025-0001	Maintain an M240B Machine Gun
071-312-4025	Maintain an M249 Machine Gun
071-022-0001	Maintain a Caliber .50 M2 Machine Gun
071-030-0001	Maintain an MK19 Machine Gun

**Table 4-1. Warrior task crosswalk**

<b>Supporting Task Number</b>	<b>Description</b>
<b>31: Evaluate a Casualty</b>	
081-831-1001	Evaluate a Casualty (Tactical Combat Casualty Care)
<b>32: Perform Combat Life Saving for Open Wound (Abdominal, Chest, and Head)</b>	
081-831-1025	Perform First Aid for an Open Abdominal Wound
081-831-1026	Perform First Aid for an Open Chest Wound
081-831-1033	Perform First Aid for an Open Head Wound
<b>33: Perform Combat Life Saving for Bleeding of Extremity</b>	
081-831-1032	Perform First Aid for a Bleeding and/or Severed Extremity
<b>34: Perform Tactical Combat Casualty Care</b>	
081-831-1001	Evaluate a Casualty (Tactical Combat Casualty Care)
<b>35: Perform Field Sanitation and Preventative Medicine Fieldcraft</b>	
081-831-1053	Practice Individual Preventive Medicine
<b>36: Select Temporary Fighting Position</b>	
071-326-0513	Select Temporary Fighting Positions
071-326-0557	Select Hasty Firing Positions During an Urban Operation
<b>37: Soldier as a Sensor</b>	
191-377-4254	Search a Detainee
191-377-4256	Guard Detainees
191-377-5250	Handle Enemy Personnel and Equipment
301-348-1050	Report Information of Potential Intelligence Value
301-371-1000	Report Intelligence Information
<b>38. Escalation of Force</b>	
<b>39. Personnel Recovery</b>	
<b>40: Improvised Explosive Device (IED) Detect and Defeat</b>	
See Rimer Digital Library	
<b>Battle Drills</b>	
<b>1: React to Contact (Visual, IET, Direct Fire, [Includes RPG])</b>	
07-3-D3991	React to Contact (Visual, IET, Direct Fire, [Includes RPG])
<b>2: React to Ambush (Near)</b>	
07-3-D3992	React to Ambush (Near)
<b>3: React to Ambush (Far)</b>	
07-3-D3993	React to Ambush (Far)
<b>4: React to Indirect Fire</b>	
07-3-D39934	React to Indirect Fire
<b>5: React to Chemical Attack</b>	
07-3-D3995	React to Chemical Attack

Table 4-1. Warrior task crosswalk

Supporting Task Number	Description
<b>6: Break Contact</b>	
07-3-D3996	Break Contact
<b>7: Dismount a Vehicle</b>	
07-3-D3997	Dismount a Vehicle
<b>8: Evacuate a Casualty (Dismounted and Mounted)</b>	
07-3-D3998	Evacuate a Casualty (Dismounted and Mounted)
<b>9: Establish Security at a Halt</b>	
07-3-D3999	Establish Security at a Halt
<b>10: Checkpoint Entry Operations</b>	
07-3-D399xx	Checkpoint Entry Operations
<b>11: Vehicle Roll-Over Drill</b>	
07-3-D399xx	Vehicle Roll-Over Drill



## Appendix A

### Proponent School or Agency Codes

The first three digits of the task number identify the proponent school or agency responsible for the task. Record any comments or questions regarding the task summaries contained in this manual on a DA Form 2028 (*Recommended Changes to Publications and Blank Forms*) and send it to the proponent school with an information copy to—

Commander, U.S. Army Training Support Center  
ATTN: ATIC-ITSC-CM  
Fort Eustis, VA 23604-5166.

<b>Table A-1. Proponent School or Agency Codes</b>	
<b><i>School Code</i></b>	<b><i>Command</i></b>
MANSCEN CM <b>031</b>	US Army Chemical School Directorate of Training/Training Development 464 MANSCEN Loop, Suite 2617 Fort Leonard Wood, MO 65473-8929
MANSCEN EN <b>052</b>	Commandant, U.S. Army Engineer School ATTN: ATSE-DT (Individual Training Division) 320 MANSCEN Loop, Suite 370 Fort Leonard Wood, MO 65473
MANSCEN MP <b>191</b>	Commandant, United States Army Military Police School ATTN: ATSJ-Z 401 MANSCEN Loop, Suite 1068 Fort Leonard Wood, MO 65473-8926
FA <b>061</b>	Directorate of Training and Doctrine U.S. Army Field Artillery School ATTN: ATSF-D Fort Sill, OK 73503-5000
IN <b>071</b>	Commandant, U.S. Army Infantry School ATTN: ATSH-OTSS Fort Benning, GA 31905-5593
AHS <b>081</b>	Department of Training Support ATTN: MCCS-HTI 1750 Greeley Rd, Ste 135 Fort Sam Houston, TX 78234-5078

**Table A-1. Proponent School or Agency Codes**

<i>School Code</i>	<i>Command</i>
SIG <b>113</b>	Commander, USA Signal Center & School ATTN: ATZH-DTM-U Fort Gordon, GA 30905-5074
AR <b>171</b>	Commander, USA Armor Center and School ATTN: ATZK-TDT-TD 204 1ST Cavalry Regiment Road Fort Knox, KY 40121-5123
JAG <b>181</b>	Commandant, Judge Advocate General Legal Center and School ATTN: JAGS-TDD 600 Massie Road Charlottesville, VA 22903-1781
APAC <b>224</b>	Director, Army Public Affairs Center 6 ACR Road, Bldg 8607 ATTN: SAPA-PA Fort Meade, MD 20755-5650
MI <b>301</b>	Commander, USA Intelligence Center & Fort Huachuca 550 Cibequa Street, Suite 168 ATTN: ATZS-TDS-I Fort Huachuca, AZ 85613-7002
JFK <b>331</b>	US Army JFK Special Warfare Center and School Fort Bragg, NC 28310-5000
CASCOM <b>093 (OMEMS)</b>	U.S. Army Combined Arms Support Command (CASCOM) Training Directorate USACASCOM, ATTN: ATCL-A 401 First St., Suite 227 Fort Lee, VA 23801-1511
QM <b>101</b>	Commander, US Army Quartermaster Center and School ATTN: ATSM-MA Fort Lee, VA 23801-5000
CASCOM <b>551</b>	U.S. Army Combined Arms Support Command (CASCOM) Training Directorate USACASCOM, ATTN: ATCL-A 401 First St., Rm 101A Fort Lee, VA 23801-1511

## Appendix B

### GUIDE TO FORMS

This appendix contains a list of forms pertinent to SMCT and CTT evaluations and administration. In the electronic, online version of this manual, hot links will, where indicated, provide downloadable and reproducible copies of the forms. The user can also visit the CTT site in the Reimer Digital Library where access to the ***CTT Manual*** and ***CTT Notice*** (Bulletin) provide additional helpful information and links. Some of these forms may be available in your unit.

**DA Form 5164-R** (*Hands On Evaluation*), used by CTT scorer to record GO/NO GO for each performance measure in a given task. Refer to the CTT Manual for the current FY (in the Reimer Digital Library) for links to DA Forms 5164-R that are overprinted with the performance measures for each task on the current CTT.

**CTT Performance Sheet** used by the CTT scorer to compile all GO/NO GO scores to produce an overall GO or NO GO for the Soldier's common task test. As with the Hands On Evaluation form above, the CTT Performance Sheet is different for each fiscal year; it is overprinted with the tasks from the current CTT and linked from the CTT Manual (in the Reimer Digital Library) for the current fiscal year.

**DA Form 5165-R** (*Field Expedient Squad Book*), used to record task proficiency for groups of Soldiers in a squad. This squad book should be especially beneficial for recording training results gathered during MTP, field exercises, or individual training sessions. Once training is completed, trainers may transfer information from DA Form 5165-R to the leader book (FM 7-10).

**CTT Roll Up for SL 1-2 and SL 3-4**, used by trainers and administrators to record performances for larger, unit-size groups of Soldiers. This form allows you to see and report the overall ratio of Soldiers passing the CTT to the total of those tested.

**DA Form 2028** (*Recommended Changes to Publications and Blank Forms*), used by Soldiers and trainers to record any comments or questions regarding the task summaries contained in this manual. Use the task proponent address for the appropriate proponent code given in appendix A (first three digits of the task number).

**This page intentionally left blank.**

## Glossary

<b>2 PAM CI</b>	pralidoxime chloride
<b>AC</b>	alternating current
<b>ACE</b>	armored combat earthmover
<b>ACR</b>	armored cavalry regiment
<b>AIDS</b>	acquired immune deficiency syndrome
<b>AIPD</b>	Army Institute for Professional Development
<b>AIT</b>	advanced individual training
<b>ANCOC</b>	advanced noncommissioned officer course
<b>APC</b>	armored personnel carrier
<b>AR</b>	Army regulation
<b>ARNG</b>	Army National Guard
<b>ASL</b>	assistant squad leader
<b>ATNAA</b>	antidote treatment nerve agent autoinjector
<b>AUD</b>	audio (panel nomenclature)
<b>AVPU</b>	alert, responds to voice, responds to pain, unresponsive
<b>AWT</b>	Army Warrior Training
<b>az</b>	azimuth
<b>ba</b>	battery
<b>BCT</b>	basic combat training
<b>BDO</b>	battle dress overgarment
<b>BDU</b>	battle dress uniform
<b>BFV</b>	Bradley fighting vehicle
<b>BII</b>	basic item issue
<b>BM</b>	benchmark
<b>BNCOC</b>	basic noncommissioned officer course
<b>BOD</b>	bore obstruction device
<b>BTB</b>	believed-to-be
<b>BVO</b>	black vinyl overboots
<b>C2W</b>	command and control warfare
<b>CA</b>	Civil Affairs
<b>CAM</b>	chemical-agent monitor
<b>CANA</b>	convulsant antidote for nerve agents
<b>CASEVAC</b>	casualty evacuation
<b>C-A-T</b>	combat application tourniquet
<b>CB</b>	chemical-biological
<b>CBRN</b>	chemical, biological, radiological, and nuclear
<b>CCW</b>	counterclockwise
<b>cGyph</b>	centigray per hour
<b>CL</b>	classification

<b>CLP</b>	cleaner, lubricant, and preservative
<b>clr</b>	clear (panel nomenclature)
<b>cm</b>	centimeters
<b>co</b>	company
<b>COE</b>	contemporary operating environment
<b>CPFC</b>	chemical protective footwear cover
<b>CPR</b>	cardiopulmonary resuscitation
<b>CSF</b>	cerebrospinal fluid
<b>CTT</b>	common task test
<b>CVC</b>	combat vehicle crewman
<b>DA</b>	Department of the Army
<b>DNBI</b>	disease and nonbattle injury
<b>DOD</b>	Department of Defense
<b>DS</b>	decontaminating solution
<b>DTG</b>	date-time group
<b>DU</b>	depleted uranium
<b>EHI</b>	extra-high intensity
<b>EMP</b>	electromagnetic pulse
<b>EMR</b>	electromagnetic radiation
<b>EOD</b>	explosive ordnance disposal
<b>ETS</b>	expiration term of service
<b>F</b>	Fahrenheit, fail
<b>FDC</b>	fire direction center
<b>FEBA</b>	forward edge of the battle area
<b>FM</b>	frequency modulated
<b>FORSCOM</b>	United States Army Forces Command
<b>FPL</b>	final protective line
<b>FRAGO</b>	fragmentary order
<b>FTX</b>	field training exercise
<b>FY</b>	fiscal year
<b>G2</b>	Assistant Chief of Staff (Intelligence)
<b>G3</b>	Assistant Chief of Staff (Operations and Plans)
<b>GI</b>	government issue
<b>G-M</b>	grid-magnetic
<b>GPS</b>	global positioning system
<b>GTA</b>	graphic training aid
<b>HAZMAT</b>	hazardous material
<b>HE</b>	high explosive
<b>HEPA</b>	high-efficiency particulate air
<b>HIV</b>	human immune deficiency virus
<b>HOB</b>	height of burst

<b>HMMWV</b>	high-mobility multipurpose wheeled vehicle
<b>HQ</b>	headquarters
<b>hr</b>	hour
<b>HRCRD</b>	handheld remote control radio device
<b>HSB</b>	heavy separate brigade
<b>HUMINT</b>	human intelligence
<b>IAW</b>	in accordance with
<b>ID</b>	identification
<b>IED</b>	improvised explosive device
<b>IEDK</b>	individual equipment decontamination kit
<b>IMINT</b>	imagery intelligence
<b>ISO</b>	International Organization for Standardization
<b>IVIS</b>	intervehicular information system
<b>JP</b>	joint publication
<b>JSLIST</b>	joint-Service, lightweight integrated suit technology
<b>LAW</b>	lubricating oil arctic weather
<b>lb</b>	pound
<b>LBE</b>	load-bearing equipment
<b>LCE</b>	load-carrying equipment
<b>LCSS</b>	Lightweight Camouflage Screen System
<b>LED</b>	light emitting diode
<b>LSA</b>	lubricating oil, semifluid, automatic weapon
<b>m</b>	meter
<b>MACOM</b>	major Army command
<b>mag</b>	magnetic
<b>MASINT</b>	measurement and signature intelligence
<b>MCSR</b>	materiel condition status report
<b>MEDEVAC</b>	medical evacuation
<b>METL</b>	mission essential task list
<b>METT-TC</b>	mission, enemy, terrain and weather, troops and support available,time available, civil considerations
<b>MIJI</b>	meaconing, intrusion, jamming, and interference
<b>min</b>	minute
<b>mm</b>	millimeter
<b>MOA</b>	minute of adjustment
<b>MOPP</b>	mission-oriented protective posture
<b>MOS</b>	military occupational specialty
<b>MOUT</b>	military operations in urban terrain
<b>MP</b>	military police
<b>mph</b>	miles per hour
<b>MRE</b>	meal, ready to eat

<b>MTP</b>	mission training plan
<b>MULO</b>	multipurpose overboots
<b>NA</b>	not applicable
<b>NATO</b>	North Atlantic Treaty Organization
<b>NBC</b>	nuclear, biological, and chemical
<b>NBCC</b>	nuclear, biological, and chemical center
<b>NCO</b>	noncommissioned officer
<b>NCOIC</b>	noncommissioned officer in charge
<b>NCS</b>	net control station
<b>NL</b>	no limit
<b>NMC</b>	not mission capable
<b>NPA</b>	nasopharyngeal airway
<b>NSN</b>	National Stock Number
<b>OBSINTEL</b>	obstacle intelligence
<b>OEG</b>	operational exposure guidance
<b>OIP</b>	organizational inspection program
<b>OPLAN</b>	operations plan
<b>OPORD</b>	operations order
<b>OPREP</b>	operations report
<b>OPSEC</b>	operations security
<b>OSUT</b>	one-station unit training
<b>OT</b>	observer-target
<b>P</b>	pass
<b>PAC</b>	personnel actions center
<b>PASGT</b>	personnel armor system ground troop
<b>PATI</b>	protection assessment test instrument
<b>PATS</b>	protection assessment test system
<b>PBIED</b>	person-borne improvised explosive device
<b>PCS</b>	permanent change of station
<b>PDF</b>	principal direction of fire
<b>PLDC</b>	Primary Leadership Development Course
<b>plt</b>	platoon
<b>PMCS</b>	preventive maintenance checks and services
<b>PMM</b>	preventive medicine measure
<b>POL</b>	petroleum, oils, and lubricants
<b>PW</b>	prisoner of war
<b>pwr</b>	power (panel nomenclature)
<b>qt</b>	quart/quarterly
<b>RALS</b>	right add/left subtract
<b>RBC</b>	rifle bore cleaner
<b>ROE</b>	rules of engagement



<b>ROI</b>	rules of interaction
<b>RP</b>	reference point
<b>RPG</b>	rocket-propelled grenade
<b>RSTA</b>	reconnaissance, surveillance, and target acquisition
<b>RT</b>	radio transmission
<b>RUF</b>	rules for the use of force
<b>RYE</b>	retirement year ending
<b>S-1</b>	personnel staff officer
<b>SA</b>	semiannually
<b>SALUTE</b>	size, activity, location, unit, time, and equipment
<b>SANDI</b>	stop, assess, note, draw back, inform
<b>SC</b>	single channel
<b>SERE</b>	survival, evasion, resistance, or escape
<b>SD</b>	self development
<b>SIB</b>	separate infantry brigade
<b>SITREP</b>	situation report
<b>SINGARS</b>	single-channel ground and airborne radio system
<b>SL</b>	skill level
<b>SM</b>	Soldier's manual
<b>SMCT</b>	Soldier's manual of common tasks
<b>SME</b>	subject matter expert
<b>SOI</b>	signal operation instructions
<b>SOP</b>	standing operating procedure
<b>SP</b>	start point
<b>SPOTREP</b>	spot report
<b>sqd</b>	squad
<b>SSN</b>	social security number
<b>STB</b>	super tropical bleach
<b>STD</b>	sexually transmitted disease
<b>STP</b>	Soldier's training publication
<b>T&amp;E</b>	traversing and elevation
<b>TACSOP</b>	tactical standing operating procedure
<b>TC</b>	training circular
<b>TCCC</b>	tactical combat casualty care
<b>TEK</b>	traffic encryption key
<b>TM</b>	technical manual
<b>TOC</b>	tactical operations center
<b>TOE</b>	table of organization and equipment
<b>TOW</b>	tube launched, optically tracked, wire guided
<b>TSC</b>	training support center
<b>TSOP</b>	tactical standing operating procedure

<b>TT</b>	tactical telephone
<b>TW</b>	target width
<b>TWS</b>	thermal weapon sight
<b>UCMJ</b>	Uniform Code of Military Justice
<b>UIC</b>	unit identifier code
<b>ULLS-G</b>	unit level logistics system-ground
<b>UN</b>	United Nations
<b>U.S.</b>	United States
<b>USAR</b>	United States Army Reserve
<b>UXO</b>	unexploded ordnance
<b>VBIED</b>	vehicle-borne improvised explosive device
<b>WBG</b>	wet bulb globe temperature
<b>WO</b>	warning order
<b>WTBD</b>	warrior tasks and battle drills

## References

### REQUIRED PUBLICATIONS

Required publications are sources that users must read to understand or comply with this publication.

#### ARMY REGULATIONS

AR 350-30. *Code of Conduct/Survival, Evasion, Resistance and Escape (SERE) Training*. 10 December 1985.

AR 530-1. *Operations Security (OPSEC)*. 27 September 2005.

AR 750-1. *Army Materiel Maintenance Policy*. 27 June 2006.

#### FORMS

DA Form 1594. *Daily Staff Journal or Duty Officer's Log*.

DA Form 2404. *Equipment Inspection and Maintenance Worksheet*.

DA Form 2823. *Sworn Statement*.

DA Form 4002. *Evidence/Property Tag*.

DA Form 4137. *Evidence/Property Custody Document*.

DA Form 5517-R. *Standard Range Cards (LRA)*.

DA Form 5988-E. *Equipment Inspection Maintenance Worksheet (EGA)*.

DD Form 565. *Statement of Recognition of Deceased (LRA)*.

DD Form 567. *Record of Search and Recovery (EGA)*.

DD Form 626. *Motor Vehicle Inspection (Transporting Hazardous Materials)*.

DD Form 836. *Dangerous Goods Shipping Paper/Declaration and Emergency Response Information for Hazardous Materials Transported By Government Vehicles*.

DD Form 1074. *Questionnaire of Local Inhabitants (EGA)*.

DD Form 1076. *Military Operations Record of Personal Effects of Deceased Personnel (EGA)*.

DD Form 1079. *Interment/Disinterment Register (EGA)*.

DD Form 2745. *Enemy Prisoner of War (EPW) Capture Tag*.

#### DEPARTMENT OF THE ARMY PAMPHLETS

DA Pam 750-1. *Leader's Unit Level Maintenance Handbook*. 3 October 2003.

DA Pam 750-8. *The Army Maintenance Management System (TAMMS) Users Manual*. 22 August 2005.

DA Pam 750-35. *Guide For Motor Pool Operations*. 1 August 1994.

#### FIELD MANUALS

FM 3-05.71. *Resistance and Escape (U)*. 7 September 2001.

FM 3-11.3 (FM 3-3, FM 3-3-1). *Multiservice Tactics, Techniques, and Procedures for Chemical, Biological, Radiological, and Nuclear Contamination Avoidance* {MCWP 3-37.2A, NTTP 3-11.25, AFTP(I) 3-2.56}. 2 February 2006.

FM 3-11.4. *Multiservice Tactics, Techniques, and Procedures for Nuclear, Biological, and Chemical (NBC) Protection*. {MCWP 3-372, NTTP 3-11.27, AFTTP(I) 3-2.46} 2 June 2003.

- FM 3-11.5 (FM 3-5). *Multiservice Tactics, Techniques, and Procedures for Chemical, Biological, Radiological, and Nuclear Decontamination*. {MCWP 3-37.3, NTTP 3-11.26, AFTP(I) 3-2.60,} 4 April 2006.
- FM 3-19.15. *Civil Disturbance Operations*. 18 April 2005.
- FM 3-19.30. *Physical Security*. 8 January 2001.
- FM 3-21.71. *Mechanized Infantry Platoon and Squad (Bradley)*. 20 August 2002.
- FM 3-22.68. *Crew-Served Machine Guns, 5.56-MM and 7.62-MM*. 31 January 2003.
- FM 3-25.26. *Map Reading and Land Navigation*. 18 January 2005.
- FM 3-34. *Engineer Operations*. 2 January 2004.
- FM 3-34.2. *Combined-Arms Breaching Operations*. 31 August 2000.
- FM 5-34. *Engineer Field Data*. 19 July 2005.
- FM 21-31. *Topographic Symbols*. 19 June 1961 (will be revised as FM 3-34.31).
- FM 21-305. *Manual for the Wheeled Vehicle Driver*. {AFMAN 24-306} 27 August 1993.

## TECHNICAL MANUALS

- TM 3-4240-279-10. *Operator's Manual for Mask, Chemical-Biological: Field, ABC-M17 (NSN 4240-00-542-4450) Small; (4240-00-542-4451) Medium; (4240-00-542-4452) Large; M17A1 (4240-00-926-4199) Small; (4240-00-926-4201) Medium; (4240-00-926-4200) Large; M17A2 (4240-01-143-2017); X-Small (4240-01-143-2018); Small (4240-01-143-2019); Medium (4240-01-143-2020); Large*. 5 October 1987.
- TM 3-4240-280-10. *Operator's Manual for Mask, Chemical-Biological: Aircraft, ABC-M24 and Accessories and Mask, Chemical-Biological, Tank, M25A1 and Accessories*. 15 March 1988.
- TM 3-4240-300-10-2. *Operator's Manual for Chemical-Biological Mask: Combat Vehicle, M42 (NSN 4240-01-258-0064) Small, (4240-01-258-0065) Medium, (4240-01-258-0066) Large*. 30 August 1988.
- TM 3-4240-312-12&P. *Operator's and Unit Maintenance Manual for Mask, Chemical-Biological: Aircraft, M43, Type I (NSN 4240-01-208-6966); Small (4240-01-208-6967); Medium (4240-01-208-6968); Large (4240-01-208-6969); Extra Large, Type II (4240-01-265-2677); Small (4240-01-265-2679); Medium (4240-01-265-2678); Large (4240-01-265-2680); Extra Large*. 30 June 1988.
- TM 3-4240-346-10. *Operator's Manual for Chemical-Biological Mask: Field, M40A1 (NSN 4240-01-370-3821-Small) (4240-01-370-3822-Medium) (4240-01-370-3823-Large); Chemical-Biological Mask: Combat Vehicle, M42A2 (4240-01-4100-Small) (4240-01-413-4101-Medium) (4240-01-413-4102-Large)*. 1 August 1998.
- TM 3-6665-307-10. *Operator's Manual for Chemical Agent Detector Kit, M256 (NSN 6665-01-016-8399) and M256A1 (6665-01-133-4964)*. 1 September 1985.
- TM 3-6665-311-10. *Operator's Manual for Paper, Chemical Agent Detector: M9 (NSN 6665-01-226-5589)*. 31 August 1998.
- TM 3-9905-001-10. *Operator's Manual for Sign Kit, Contamination (NSN 9905-01-346-4716) {TO IID1-3-10-1}*. 23 August 1982.
- TM 10-8415-209-10. *Operator's Manual for Individual Chemical Protective Clothing*. {TM 8415-10/2} 31 March 1993.
- TM 10-8415-220-10. *Operator Manual for Joint Service Lightweight Integrated Suit Technology (JSLIST) Chemical Protective Ensemble*. 1 September 1998.
- TM 11-5820-401-10-2. *Operator's Manual for Radio Sets, AN/VRC-12 (NSN 5820-00-223-7412) (EIC: GCC); AN/VRC-43 (5820-00-223-7415) (EIC: GCD);*

*AN/VRC-44 (5820-00-223-7417) (EIC: GCE); AN/VRC-45 (5820-00-223-7418) (EIC: GCF); AN/VRC-46 (5820-00-223-7433) (EIC: GCG); AN/VRC-47 (5820-00-223-7434) (EIC: GCH); AN/VRC-48 (5820-00-223-7435) (EIC: GCH); AN/VRC-49 (5820-00-223-7437) (EIC: GCK) (Used With An Intercom System).*  
23 November 1982.

TM 11-5820-890-10-8. *Operator's Manual for SINCGARS Ground Combat Net Radio, ICOM MANPACK Radio, AN/PRC-119A (NSN 5820-01-267-9482) (EIC: I2Q); Short Range Vehicular Radio AN/VRC-87A (5820-01-267-9480) (EIC: L22); Short Range Vehicular Radio with Single Radio Mount AN/VRC-87C (5820-01-304-2045) (EIC: GDC); Short Range Vehicular (Short Range/ Long Range Vehicular Radio AN/VRC-92A (5820-01-267-9477) (EIC: L27); Used With Automated Net Control Device (ANCD) (AN/CYZ-10) Precision Lightweight GPS Receiver (PLGR) (AN/PSN-11) Secure Telephone Unit (STU) Frequency Hopping Multiplexer (FHMUX).* 1 December 1998.

TM 11-6665-251-10. *Operator's Manual for Radiac Set AN/VDR-2 (NSN 6665-01-222-1425).* 1 March 1988.

## **OTHER PUBLICATIONS**

ACP 125 (E). *Communication Instructions - Radiotelephone Procedures.* 1 August 1987.

ACP 125 US Supp-1. *Communications Instructions Radiotelephone Procedures for Use by United States Ground Forces.* 1 October 1985.

GTA 03-04-001A. *Depleted Uranium Awareness.* 1 October 1999.

GTA 03-06-008. *NBC Warning and Reporting System.* 1 August 1996.

GTA 05-02-012. *Coordinate Scale and Protractor (Simple Device).* 2 January 1981.

JP 4-06. *Mortuary Affairs in Joint Operations.* 5 June 2006.

STP 19-95B1-SM. *Soldier's Manual for MOS 95B, Military Police Skill Level 1.* 14 January 2003.

TC 3-41. *Protection Assessment Test System (PATS).* 14 January 1995.

## **RELATED PUBLICATIONS**

Related publications are sources of additional information; they are not required to understand this publication.

## **ARMY REGULATIONS**

AR 50-5. *Nuclear Surety.* 1 August 2000.

AR 190-13. *The Army Physical Security Program.* 30 September 1993.

AR 350-1. *Army Training and Leader Development.* 13 January 2006.

AR 385-10. *The Army Safety Program.* 29 February 2000.

AR 385-40. *Accident Reporting and Records.* 1 November 1994.

AR 385-55. *Prevention of Motor Vehicle Accidents.* 12 March 1987.

AR 525-13. *Antiterrorism.* 4 January 2002.

AR 600-3. *The Army Personnel Proponent System.* 28 November 1997.

AR 600-13. *Army Policy for the Assignment of Female Soldiers.* 27 March 1992.

AR 600-20. *Army Command Policy.* 7 June 2006.

AR 600-55. *The Army Driver and Operator Standardization Program (Selection, Training, Testing, and Licensing).* 31 December 1993.

AR 600-63. *Army Health Promotion.* 28 April 1996.

- AR 700-4. *Logistics Assistance*. 17 March 2006.
- AR 700-138. *Army Logistics Readiness and Sustainability*. 26 February 2004.
- AR 710-2. *Supply Policy Below the National Level*. 8 July 2005.
- AR 725-50. *Requisition, Receipt, and Issue System*. 15 November 1995.
- AR 735-5. *Policies and Procedures for Property Accountability*. 28 February 2005.
- AR 750-43. *Army Test, Measurement and Diagnostic Equipment Program*. 14 December 2004.

**ARMY TRAINING AND EVALUATION PROGRAM PUBLICATIONS**

- ARTEP 7-7J-Drill. *Battle Drills for the Bradley Fighting Vehicle Platoon, Section, and Squad*. 28 June 2002.
- ARTEP 7-8-Drill. *Battle Drills for the Infantry Rifle Platoon and Squad*. 25 June 2002.
- ARTEP 7-8-MTP. *Mission Training Plan for the Infantry Rifle Platoon and Squad*. 29 September 1994.
- ARTEP 17-57-11-MTP. *Scout Crew and Team Training Plan*. 23 December 2002.

**DEPARTMENT OF THE ARMY PAMPHLETS**

- DA Pam 25-30. *Consolidated Index of Army Publications and Blank Forms*. 1 July 2006.
- DA Pam 350-20. *Unit Equal Opportunity Training Guide*. 1 June 1994.
- DA Pam 350-59. *Army Correspondence Course Program Catalog*. 1 October 2002.
- DA Pam 600-26. *The Department of the Army Affirmative Action Plan*. 23 May 1990.
- DA Pam 710-2-1. *Using Unit Supply System (Manual Procedures)*. 31 December 1997.
- DA Pam 710-2-2. *Supply Support Activity Supply System: Manual Procedures*. 30 September 1998.

**FIELD MANUALS**

- FM 2-0. *Intelligence*. 17 May 2004.
- FM 3-0. *Operations*. 14 June 2001.
- FM 3-06. *Urban Operations*. 1 June 2003.
- FM 3-06.11. *Combined Arms Operations in Urban Terrain*. 28 February 2002.
- FM 3-7. *NBC Field Handbook*. 29 September 1994 (will be revised as FM 3-11.7).
- FM 3-19.40 (FM 19-40). *Military Policy Internment/Resettlement Operations*. 1 August 2001.
- FM 3-20.15 (FM 17-15). *Tank Platoon*. 1 November 2001.
- FM 3-20.98. *Reconnaissance Platoon*. 2 December 2002.
- FM 3-22.9. *Rifle Marksmanship M16A1, M16A2/3, M16A4 and M4 Carbine*. 24 April 2003.
- FM 3-22.27. *MK 19, 40-MM Grenade Machine Gun, MOD 3*. 28 November 2003.
- FM 3-22.65. *Browning Machine Gun, Caliber .50 HB, M2*. 3 March 2005.
- FM 3-23.24. 47 (FM 23-24). *Dragon Medium Antitank Weapon System*. 30 August 2001.
- FM 3-23.25. *Shoulder-Launched Munitions*. 31 January 2006.
- FM 3-23.30. *Grenades and Pyrotechnic Signals*. 7 June 2005
- FM 3-23.35. *Combat Training With Pistols, M9 and M11*. 25 June 2003.

FM 3-25.150. *Combatives*. 18 January 2002.

FM 3-90.1 (FM 71-1). *Tank and Mechanized Infantry Company Team*. 9 December 2002.

FM 4-01.011. *Unit Movement Operations*. 31 October 2002.

FM 4-01.30. *Movement Control*. 1 September 2003.

FM 4-25.11. *First Aid*. {NTRP 4-02.1.1; AFMAN 44-163(I); MCRP 3-02G}. 23 December 2002.

FM 4-30.3. *Maintenance Operations and Procedures*. 28 July 2004.

FM 5-0. *Army Planning and Orders Production*. 20 January 2005.

FM 5-10. *Combat Engineer Platoon*. 3 October 1995 (will be revised as FM 3-34.21).

FM 5-102. *Countermobility*. 14 March 1985 (will be revised as FM 3-34.1).

FM 6-30. *Tactics, Techniques, and Procedures for Observed Fire*. 16 July 1991 (will be revised as FM 3-09.30).

FM 7-7. *The Mechanized Infantry Platoon and Squad*. 15 March 1985 (will be revised as FM 3-21.7).

FM 7-8. *Infantry Rifle Platoon and Squad*. 22 April 1992 (will be revised as FM 3-21.8).

FM 8-10-6. *Medical Evacuation in a Theater of Operations Tactics, Techniques, and Procedures*. 14 April 2000 (will be revised as FM 4-02.2).

FM 19-10. *The Military Police Law and Order Operations*. 30 September 1987 (will be revised as FM 3-19.10)

FM 20-3. *Camouflage, Concealment, and Decoys*. 30 August 1999 (will be revised as FM 3-34-205).

FM 20-32. *Mine/Countermine Operations*. 29 May 1998 (will be revised as FM 3-34.34.210).

FM 21-10. *Field Hygiene and Sanitation*. 21 June 2000 (will be revised as FM 4-25.10).

FM 4-30.51 (FM 21-16). *Unexploded Ordnance (UXO) Procedures*. {MCRP 3-17.2A} 13 July 2006.

FM 21-20. *Physical Fitness Training*. 30 September 1992 (will be revised as FM 3-22.20).

FM 21-60. *Visual Signals*. 30 September 1987 (will be revised as FM 3-21.60).

FM 21-75. *Combat Skills of the Soldier*. 3 August 1984 (will be revised as FM 3-21.75).

FM 22-6. *Guard Duty*. 17 September 1971 (will be revised as FM 3-21.6).

FM 23-23. *Antipersonnel Mine M18A1 and M18 (Claymore)*. 6 January 1966 (will be revised as FM 3-22.23).

FM 24-18. *Tactical Single-Channel Radio Communications Techniques*. 30 September 1987.

FM 24-19. *Radio Operator's Handbook*. 24 May 1991.

FM 24-24. *Signal Data References: Signal Equipment*. 29 December 1994 (will be revised as FM 6-02.24).

FM 25-4. *How to Conduct Training Exercises*. 10 September 1984 (will be revised as FM 7-2).

FM 27-10. *The Law of Land Warfare*. 18 July 1956 (will be revised as FM 1-04.10).

FM 34-60. *Counterintelligence*. 3 October 1995 (will be revised as FM 2--22.2).

- FM 41-10. *Civil Affairs Operations*. 14 February 2000 (will be revised as FM 3-05.40).
- FM 55-1. *Transportation Operations*. 3 October 1995 (will be revised as FM 4-01).
- FM 55-15. *Transportation Reference Data*. 27 October 1997 (will be revised as FM 4-01.15).
- FM 55-30. *Army Motor Transport Units and Operations*. 27 June 1997 (will be revised as FM 4-01.40).
- FM 90-3. *Desert Operations*. 24 August 1993.
- FM 100-17. *Mobilization, Deployment, Redeployment, Demobilization*. 28 October 1992 (will be revised as FM 3-35).

## **FORMS**

- DA Form 5164-R. *Hands-on Evaluation*.
- DA Form 5165-R. *Field Expedient Squad Book*.

## **GRAPHIC TRAINING AIDS**

- GTA 05-10-044. *Mine Awareness (SANDI)*. 1 May 1999.
- GTA 09-12-001. *Unexploded Ordnance (UXO) Procedures*. 30 January 1992.
- GTA 17-02-011. *Combat Vehicle Identification*. 3 January 1984.
- GTA 21-03-10. *Code of Conduct*. 2 October 1989.

## **SOLDIER TRAINING PUBLICATIONS**

- STP 17-19D1-SM. *Soldier's Manual Cavalry Scout MOS 19D Skill Level 1*. 23 January 2004.
- STP 21-24-SMCT. *Soldier's Manual of Common Tasks (SMCT) Skill Levels 2-4*. 31 August 2003.
- STP 55-88M14-SM-TG. *Soldier's Manual and Trainer's Guide for MOS 88M, Motor Transport Operator, Skill Levels 1, 2, 3, and 4*. 6 October 2004.

## **TECHNICAL BULLETINS**

- TB 9-1300-278. *Guidelines for Safe Response to Handling, Storage, and Transportation Accidents Involving Army Tank Munitions or Armor Which Contain Depleted Uranium*. 21 July 1996.
- TB 11-5825-291-10. *Satellite Signals Navigation Sets AN/PSN-11 (NSN 5825-01-374-6643) and AN/PSN-11(V)1 (5825-01-395-3513)*. {TO 31R4-2PSN11-1CL-1; EE174-AA-OPI-010/PSN-11} 15 September 1995.
- TB 55-46-1. *Standard Characteristics (Dimensions, Weight, and Cube) for Transportability of Military Vehicles and Other Outsize/Overweight Equipment (in TOE Line Item Number Sequence)*. 1 January 2006.

## **TRAINING CIRCULAR**

- TC 7-98-1. *Stability and Support Operations Training Support Package*. 5 June 1997.
- TC 19-138. *Civilian Law Enforcement and Security Officer Training*. 1 August 2001.
- TC 20-32-5. *Commander's Reference Guide for Land Mine and Explosive Hazards (IRAQ)*. 13 February 2003.
- TC 26-6. *Commander's Equal Opportunity Handbook*. 14 October 1994.
- TC 63-1. *Warfighter Handbook for Combat Service Support Live Fire Exercises*. 20 December 2004.
- TC 90-1. *Training for Urban Operations*. 1 April 2002.



## TECHNICAL MANUAL

- TM 3-4230-229-10. *Operator's Manual for Decontaminating Kit, Skin: M291, (NSN 4230-01-251-8702). {SS010-AA-MMO-1-0; TO 11D1-1-131 TM 4230-10/1} 2 October 1989.*
- TM 3-4230-235-10. *Operator's Manual for Decontamination Kit, Individual Equipment: M295 (NSN 6850-01-357-8456). (EIC: Y67) 20 February 1994.*
- TM 3-4240-279-20&P. *Unit Maintenance Manual (Including Repair Parts and Special Tools List) for Mask, Chemical-Biological; Field, ABC-M17 (NSN 4240-00-542-4450), (Small), (4240-00-542-4451), (Medium) and (4240-00-542-4452), (Large); M17A1 (4240-00-926-4199), (Small), (4240-00-926-4201), (Medium) and (4240-00-926-4200) (Large) and M17A2 (4240-01-143-2017), (X-Small), (4240-01-143-2018), (SMALL), (4240-01-143-2019), (Medium) and (4240-01-143-2020), (Large). 5 October 1987.*
- TM 38-250. *Preparing Hazardous Materials for Military Air Shipments. {AFMAN 24-204; NAVSUP PUB 505; MCO P4030.191; DLAI 4145.3} 12 October 2004.*
- TM 9-1005-201-10. *Operator's Manual for Machine Gun, 5.56-MM, M249 W/Equip (NSN 1005-01-127-7510). (EIC: 4BG) 26 July 1991.*
- TM 9-1005-213-10. *Operator's Manual For Machine Guns, Caliber .50; M2, Heavy Barrel Flexible, W/E (NSN 1005-00-322-9715) (EIC: 4AG) M48 Turret Type (1005-00-957-3893) (EIC: 4BB) Soft Mount (1005-01-343-0747) (Navy) Fixed Type Right Hand Feed (1005-00-122-9339) (Navy) Fixed Type Left Hand Feed (1005-00-122-9368) (Navy) {TM 02498A-10/2; TO 11W2-6-3-161; SW361-AB-MMO-010}. 1 June 2001.*
- TM 9-1005-313-10. *Operator's Manual for Machine Gun, 7.62MM, M240 (NSN 1005-01-025-8095); M240B (1005-01-412-3129); M240C (1005-01-085-4758); M240D (1005-01-418-6995); M240E1 (1005-01-252-4288); M240G (1005-01-359-2714); M240H (1005-01-518-2410); M240N (1005-01-493-1666). {TO 11W2-6-5-1; TM 08670A/09712A-10/1B; SW360-AH-OPI-010} 15 November 2002.*
- TM 9-1005-319-10. *Operator's Manual for Rifle, 5.56 MM, M16A2 W/E (NSN 1005-01-128-9936) (EIC: 4GM); Rifle, 5.56 MM, M16A3 (1005-01-357-5112); Rifle, 5.56 MM, M16A4 (1005-01-383-2872) (EIC: 4F9); Carbine, 5.56 MM, M4 W/E (1005-01-231-0973) (EIC: 4FJ); Carbine, 5.56 MM, M4A1 (1005-01-382-0953). (EIC: 4GC) {TO 11W3-5-5-41; SW 370-BU-OPI-010} 1 October 1998.*
- TM 9-1010-230-10. *Operator's Manual For Machine Gun, 40-MM, MK 19, MOD 3 (NSN 1010-01-126-9063). (EIC: 4AE) {TM 08521A-10/1A; TO 11W2-5-16-1; SW 363-C3-MMM-010} 30 May 2001.*
- TM 9-2320-260-10. *Operator's Manual for Truck, 5-TON, 6X6, M809 Series (Diesel): Truck, Cargo: M813, M813A1 and M814; Truck, Bolster, Logging: M815; Truck, Wrecker, Medium: M816; Truck, Dump: M817; Truck, Tractor: 818; Truck, Tractor, Wrecker: M819; Truck, Van, Expansibile: 820, M820A1 and M820A2 and Truck, Stake, Bridge Transporting: M821. {TO 36A12-1C-481} 14 June 1985.*
- TM 9-2320-272-10. *Operator's Manual For Truck, 5-Ton, 6X6, M939, M939A1, and M939A2 Series Trucks (Diesel), Truck, Cargo: 5-TON, 6X6 Dropside, M923 (2320-01-050-2084) (EIC: BRY); M923A1 (2320-01-206-4087) EIC: BSS); M923A2 (2320-01-230-0307) (EIC: BS7); M925 (2320-01-047-8769) (EIC: BRT) M925A1 (2320-01-206-4088) (EIC: BST); M925A2 (2320-01-230-0308). (EIC: ) 6X6, M936 (2320-01-047-8754) ( EIC: BTF); M936A1 (2320-*

01-206-4078) (EIC: BS6); M936A2 (2320-01-230-0304) (EIC: BTT) {TO 36A12-1C-441}. 15 August 1996.

TM 9-2320-279-10-1. *Operator's Manual for M977 Series 8X8 Heavy Expanded Mobility Tactical Trucks (HEMTT), Truck, Cargo, with Winch, M977 (NSN 2320-01-097-0260) Truck, Cargo, with Winch, M977A2 (2320-01-493-3774) Truck, Cargo, with Winch, M977A2R1 (2320-01-493-3782) Truck, Cargo, Without Winch, M977 with Winch, M985E1 (2320-01-194-7032) Truck, Cargo, with Winch, M985E1A2 (2320-01-493-3790) Truck, Cargo, with Winch, M985E1A2R1 (2320-01-493-3792)*. 21 November 1986.

TM 9-2320-279-10-2. *Operator's Manual for M977 Series, 8X8 Heavy Expanded Mobility Tactical Trucks (HEMTT) Truck, Cargo, With Winch M977 (2320-01-097-0260) Truck, Cargo, With Winch, M977A2 (2320-01-493-3774) Truck, Cargo, With Winch, M977A2R1 (2320-01-493-3782) Truck, Cargo, Without Winch, M977 (2320-01-099-6426), Truck, Cargo, with Winch, M985E1 (2320-01-194-7032) Truck, Cargo, with Winch, M985E1A2 (2320-01-493-3790) Truck, Cargo, with Winch, M985E1A2R1 (2320-01-493-3792)*. 15 June 1987.

TM 9-2320-280-10. *Operator's Manual for Truck, Utility: Cargo/Troop Carrier, 1-1/4 Ton, 4X4, M998 (NSN 2320-01-107-7155) (EIC: BBD); M998A1 (2320-01-371-9577) (EIC: BBN); Truck, Utility: Cargo/Troop Carrier, 1-1/4, Ton, 4X4, W/Winch, M1038 (2320-01-107-7156) (EIC: BBE); M1038A1 (2320-01-371-9578) (EIC: BBP); Truck, Utility: Heavy Variant, 4X4, M1097 Ambulance, 2-Litter, Soft Top, 4X4, M1035 (2310-01-146-7194); M1035A1 (2310-01-371-9585) (EIC: BBW); M1035A2 (2310-01-380-8290) (EIC: BB9) {TO 36A12-1A-2091-1; TM 2320-10/6B}*. 31 January 1996.

TM 9-2320-283-10. *Operator's Manual for Truck Tractor, Line Haul; 50,000 GVWR, 6X4, M915A1 (NSN 2320-01-125-2640)*. 15 May 2006.

TM 9-2320-360-10. *Operator's Manual for Truck, Tractor, M1070, 8X8, Heavy Equipment Transporter (HET) (NSN 2320-01-318-9902)*. (EIC: B5C) 31 March 1994.

TM 9-2320-364-10. *Operator's Manual for Truck, Tractor, M1074 and M1075 Palletized Load System (PLS) (NSN 2320-01-304-2277) (2320-01-304-2278)*. 30 November 2005.

TM 9-2320-365-10. *Operator's Instructions Manual for M1078 Series, 2-1/2 Ton, 4X4 Light Medium Tactical Vehicles (LMTV) Trk, Car., LMTV, M1078 W/WN (NSN 2320-01-360-1898) (EIC: BHH) W/O WN (2320-01-354-3385) (EIC: BHD) Trk, Van, LMTV, M1078 W/WN (2320-01-360-1891) (EIC: BHG) W/O WN (2320-01-354-3384) (EIC: BHE) Trk, Chas, LMTV, M1080 (2320-01-353-9098). (EIC: BHC) Trk, Car., LMTV, LVAD, M1081 W/WN (2320-01-360-1899) (EIC: BHJ) W/O WN (2320-01-355-3063) (EIC: BHF)* 17 June 1998.

TM 9-2320-366-10-1. *Operator's Instructions Manual for M1083 Series, 5-TON, 6X6, Medium Tactical Vehicles (MTV) Volume No. 1 OF 2 TRK, Car., MTV, M1083 W/WN (NSN 2320-01-360-1895) (EIC: BT3) W/O WN (2320-01-354-3386) (EIC: BR2) Trk, Car., MTV, W/MATL HDLG EQPT (MHE) M1084 (2320-01-354-3387) (EIC: BR3) Trk, Car, (EIC: BT4) W/O WN (2320-01-355-3063) (EIC: BR9) TRK, Dump, MTV, Air Drop, M1094 W/WN (2320-01-360-1894) (EIC: BT2) W/O WN (2320-01-355-3062) (EIC: BTK) Trk, Chas, MTV, LWB, M1096 (2320-01-354-4527) (EIC: BR6) {TO 36A12-1C-1091-1}*. 15 September 1998.

TM 9-2320-366-10-2. *Operator's Instructions Manual for M1083 Series, 5-Ton, 6X6, Medium Tactical Vehicles (MTV) Volume No. 2 OF 2 Trk, Car., MTV, M1083 W/WN (2320-01-360-1895) (EIC: BT3) W/O WN (2320-01-354-3386)*

- (EIC: BR2) *Trk, Car., MTV, W/MATL HDLG EQPT (MHE) M1084 (2320-01-354-3387) (EIC: BR3) Trk, Car., (2320-01-360-1894) (EIC: BT2) W/O WN (2320-01-355-3062 (EIC: BTK) Trk, Chas, MTV, LWB, M1096 (2320-01-354-4527) (EIC: BR6) {TO 31A12-1C-1091-2}*. 15 September 1998.
- TM 9-2320-282-24-2. *Unit, Direct Support, and General Support Maintenance Manual for Truck, 5-Ton, 6X6, M939, M939A1, M939A2 Series Trucks (DIESEL) Truck, Cargo: 5-Ton, 6X6, Dropside, M923 (NSN 2320-01-050-2084) (EIC: BRY); M923A1 (2320-01-206-4087) (EIC: BSS); M923A2 (2320-01-230-0307) (EIC: BS7); M925 (2320-01-047-8769) (EIC: BRT); M934A2 (2320-01-230-0300) (EIC: BTR); Truck, Medium Wrecker: 5-Ton, 6X6, M936 (2320-01-047-8754) (EIC: BTF); M936A1 (2320-01-206-4078) (EIC: BS6); M936A2 (2320-01-230-0304) (EIC: BTT) {TO 36A12-1C-1155-2-2}*. 30 June 1998.
- TM 9-2330-385-14. *Operator's, Unit, Direct Support and General Support Maintenance Manual for Palletized Load System Trailer (PLST) Model M1076 (NSN 2330-01-303-5197)*. 31 December 2005.
- TM 10-8415-220-10. *Operator Manual for Joint Service Lightweight Integrated Suit Technology (JSLIST) Chemical Protective Ensemble*. 1 September 1998.
- TM 11-5820-890-10-1. *Operator's Manual for SINGGARS Ground Combat Net Radio, Icom MANPACK Radio AN/PRC-119A (NSN 5820-01-267-9482) (EIC: L2Q) Short Range Vehicular Radio AN/VRC-87A (5820-01-267-9480) (EIC: L22) Short Range Vehicular Radio with Single Radio Mount AN/VRC-87C (5820-01-304-2045) (EIC: GDC) Short Range Vehicular Radio with Radio AN/VRC-90A (5820-01-268-5105) (EIC: L25) Short Range/Long Range Vehicular Radio with Dismount AN/VRC-91A (5820-01-267-9478) (EIC: L26) Long Range/Long Range Vehicular Radio AN/VRC-92A (5820-01-267-9477) (EIC: L27)*. 1 September 1992.
- TM 11-5855-214-10. *Operator's Manual for Night Vision Sight, Crew Served Weapon, AN/TVS-5 (NSN 5855-00-629-5327)*. 15 February 1989.
- TM 11-5855-262-10-1. *Operator's Manual for Night Vision Goggle, AN/PVS-7A (NSN 5855-01-228-0939) (EIC: IPT)*. {TO 12S10-2PVS7-1} 15 March 1993.
- TM 11-5855-261-10. *Operator's Manual for Infrared Aiming Light, AN/PAQ-4 (NSN 5855-01-107-5925)*. 28 May 1981.
- TM 11-5855-301-12&P. *Operator's and Unit Maintenance Manual (Including Repair Parts and Special Tools List) for Light, Aiming, Infrared AN/PAQ-4B (NSN 5855-01-361-1362) (EIC: N/A) AN/PAQ-4C (5855-01-398-4315) (EIC: N/A) {TM 09596C-12&P/1A}*. 15 May 2000.
- TM 11-5855-303-12&P. *Operator's and Unit Maintenance Manual (Including Repair Parts and Special Tools List) for Sight, Night Vision Sniper Scope AN/PVS-10 (NSN 5855-01-410-8979)*. 1 March 2003.
- TM 11-5855-306-10. *Operator's Manual for Monocular Night Vision Device (MNVD) AN/PVS-14 (NSN 5855-01-432-0524)*. 1 June 2000.
- TM 11-5855-308-12&P. *Operator's and Unit Maintenance Manual (Including Repair Parts and Special Tools List) Target Pointer Illuminator/Aiming Light AN/PEQ-2A (NSN 5855-01-447-8992)*. 15 May 2000.
- TM 11-5855-309-12&P. *Operator's Manual Sight, Thermal AN/PAS-13B (V) 2 (NSN 5855-01-464-3152)*. 15 February 2005.

## **OTHER PUBLICATIONS**

FORSCOM Reg 55-1. *Unit Movement Planning*. 1 June 2006.

FORSCOM Reg 55-2. *Unit Movement Data Reporting and Systems Administration*.  
31 October 1997.

*Note*. FORSCOM publications are at <http://www.forscom.army.mil/pubs/>

MCM. *Manual for Courts Martial*, United States. 2005.

[http://www.army.mil/usapa/epubs/27\\_Series\\_Collection\\_1.html](http://www.army.mil/usapa/epubs/27_Series_Collection_1.html)

POI 071-D-2330. *Land Navigation 4 (Operate the Precision Lightweight Global Positioning System (PLGR))*.

DODD 1300.7. *Training and Education to Support the Code of Conduct (CoC)*. 8  
December 2000.

DODD 7050.6. *Military Whistleblower Protection*. 23 June 2000.

**By Order of the Secretary of the Army:**

**PETER J. SCHOOMAKER**  
**General, United States Army**  
**Chief of Staff**

**Official:**

A handwritten signature in black ink that reads "Joyce E. Morrow". The signature is written in a cursive style with a large, prominent initial "J".

**JOYCE E. MORROW**  
**Administrative Assistant to the**  
**Secretary of the Army**  
**0624005**

**DISTRIBUTION:**

*Active Army, Army National Guard, and U.S. Army Reserve:* Distribute in accordance with the initial distribution number IDN 111447, requirements for STP 21-1-SMCT.

**This page intentionally left blank.**

## WARRIOR ETHOS

*The Warrior Ethos forms the foundation for the American Soldier's spirit and total commitment to victory, in peace and war, always exemplifying the ethical behavior and Army Values. Soldiers put the mission first, refuse to accept defeat, never quit, and never leave behind a fellow American. Their absolute faith in themselves and their comrades makes the United States Army invariably persuasive in peace and invincible in war.*

PIN: 059832-000